

JOHN DEE,  
GOVERNOR BENEDICT ARNOLD,  
AND THE  
ANCHOR OF HOPE

© 2010 by Jim Egan. All Rights reserved.

ISBN\_10:

ISBN-13:

LCCN:

Published by  
Cosmopolite Press  
153 Mill Street  
Newport, Rhode Island 02840

Visit  
*[johndeetower.com](http://johndeetower.com)*  
for more information.

Printed in the United States of America

JOHN DEE,  
GOVERNOR BENEDICT ARNOLD,  
AND THE  
ANCHOR OF HOPE

BY  
JIM EGAN

COSMOPOLITE PRESS  
NEWPORT, RHODE ISLAND



"CITIZEN OF THE WORLD"  
(COSMOPOLITE. IS A WORD COINED  
BY JOHN DEE. FROM THE GREEK  
WORDS COSMOS MEANING "WORLD"  
AND POLITĒS MEANING "CITIZEN")

*Dedication*

To Governor Benedict Arnold,  
the First Governor of Rhode Island,  
for his strength of character in the protection of religious freedom.

## Table of Contents

page

- 1 Chronology of the Rhode Island State Seal: An Anchor and the word “Hope”
- 9 Clues in the Title page of Dee’s *General and Rare Memorials...*
- 29 The Early History of the Cross
- 49 The 42 Story
- 57 The Anchor is a symbol of the Monas symbol
- 61 Evidence that Benedict Arnold and other Colonial leaders knew about the John Dee Tower
- 73 Six clues suggesting Benedict Arnold knew how the John Dee Tower worked

# CHRONOLOGY OF THE RHODE ISLAND STATE SEAL: AN ANCHOR AND THE WORD HOPE

By their selection of names like “Rode Island” and “Monachunte” it appeared to me that the early leaders of New England were aware the Tower was designed by John Dee as an architectural Monas symbol.

This led me to suspect that the symbol of the anchor might also be a cryptic reference to the Monas symbol.

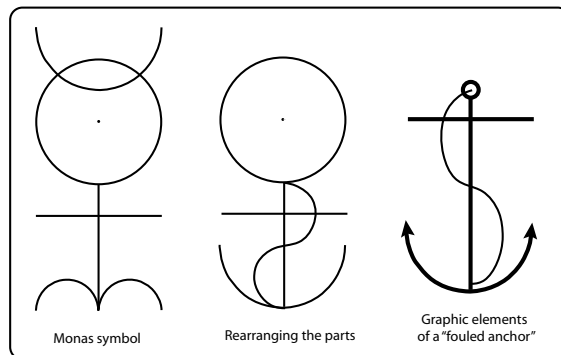

The sharp grasping hooks form an arc like the Moon’s half-circle.

The Sun, greatly reduced, is like the circle on top of the anchor.

The cross in the middle of the anchor is obvious.

The Aries symbol is like the “fouled” rope.

In 1637, a year after the founding of Providence, Roger Williams in a letter to John Winthrop, refers to “...**Aquidnetick called by us Rode Island ...**”

The only “us” at that time was Roger, a few of his poor friends, and the Arnold clan. To me it’s pretty apparent they got this name from Hakluyt’s description of Verrazano’s voyage, (even though Verrazano actually used it in reference to Block Island).

On June 14,1638, as Anne Hutchinson, William Coddington, John Clarke, and the “Anti-nomians” were settling on northern Aquidneck, Roger Williams wrote to John Winthrop:

**“Sir, concerning the islands Prudence and (Patmos, if some had not hindered) Aquedenick ...”**

Roger wanted to call Aquidneck Island Patmos, the island to which St. John was banished in 95 AD, where he wrote one of Roger’s favorite books: **Revelations**. (In 1088 AD, a Monastery was built over the cave where St. John lived. The Greek island of Rhodes is nearby, but it’s 100 times larger than tiny Patmos.)

In 1641 the “colony” seal was to be a sheaf of arrows, with the motto “**Amor Vincent omnia**” (Love conquers all.) (RI Manual, p. 12)

In 1644 the name of Aquidneck was officially changed to “Rhod Iland”(Rhode Island or the Isle of Rhodes).

In 1647 the First General Assembly made the colony seal an anchor. At this time, Benedict Arnold was still a subject of the Mass Bay Colony so he was not involved in this decision.

*(Chapin, Illustrations of the Seals, Arms, and Flags of Rhode Island)*



In 1663, Benedict Arnold was appointed by King CharlesII to be the first Governor, but it wasn’t until 1664 that he was elected by his contemporaries to that office. His very first act as elected Governor was to establish the seal for “Rhod Iland and Providence Plantations.” It was “The word Hope over the head of the anchor.”

The combination of the word Hope and the graphic of an anchor has been used many times in the history of Christianity. It seems to have originated from the Biblical passage in Hebrews 6:19:

**“We have this as a sure and steadfast anchor of the soul, a hope that enters into the inner shrine behind a curtain ...”**

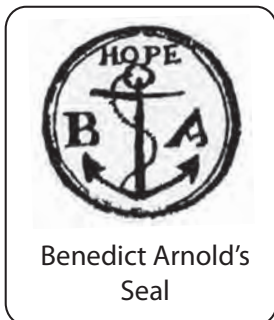

Benedict Arnold used a seal that incorporated his initials BA, the anchor (with fouled rope) and the word HOPE on his official seal. (This silver seal (one inch in diameter) has a handle (about 3 inches long, with a 3 inch diameter knob) made of polished hardwood. It is in the collection of RI Historical Society in the John Brown House in Providence.)

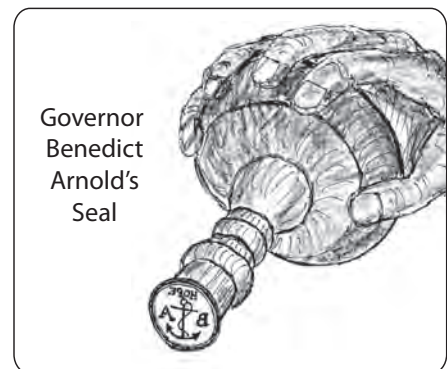

During the early 1980's a Narragansett burial ground near Wickford was accidentally unearthed by bulldozers. To prevent any looting of the site, the State of RI had it excavated by professionally archeologists (the excavation referred to as RI 1000).

A ring was found in one of the graves. Imprinted on it was an anchor with a heart. The official report in RI 100 suggests that it might of been a gift from Governor Benedict Arnold to this Indian sagamore (leader).



Ring thought to have been a gift from Benedict Arnold to an Narragansett sagamore

The ring is similar to a "Jesuit ring." French Jesuit missionaries in Northern Maine and in the Hudson Valley distributed many such rings as they proselytized. Narragansetts sometimes obtained these rings by trading with Indians from those regions.

### *The fouled anchor*

A "fouled anchor" is one whose cable has somehow gotten wrapped around its shank. It can cause real problems when hoisting it up into the boat. If it suddenly becomes unfouled, the heavy anchor might swing loose and crash through the wooden hull. Fouled anchors are not a pleasant thing for sailors.

Why, then, do these four venerable institutions (and others) have a fouled anchor for their official emblem?

The State of Rhode Island

The British Navy

The United States Navy

The Canadian Navy

My admittedly strange-sounding answer is:

They all got it from the mind of John Dee.

The fouled anchor symbols of the United States Navy and the Canadian Navy derive from that of the British Navy.

The British Navy's fouled anchor was first used by Charles Howard (1536-1624), Lord High Admiral of the British Navy in 1588 when they dramatically defeated the Spanish Armada.

In 1585, when Charles was 49 years old, Queen Elizabeth appointed him as Lord High Admiral. He proved to be a brilliant commander. When the Spanish Armada sailed north to capture the island of England in 1588, he ordered his ships to harass, but not directly attack the huge Spanish fleet.

Eight years later in 1596, another Spanish attack was eminent. Admiral Charles Howard and Robert Devereaux (Essex, one of the Queen's favorites) attacked Cadiz (on southwest of Spain). They were unable to capture and hold the city, but they sacked and burned much of the city.



To understand how Charles rose to such a prominent position let's first examine his family.

### *William Howard*

William Howard (1510-1573), the first Baron of Effingham (20 miles southwest of London). He was High Admiral of England from 1554-1558, during the reign of Queen Mary. He became Lord Chamberlain to Queen Elizabeth from 1557-1572. William was Anne Boleyn's uncle, so he was a great uncle of Queen Elizabeth.

His son Charles (1536-1634), who was 18-22 years old during his father's tenure, served at sea under the command of his father, the Lord Admiral. (this is how he "learned the ropes," so to speak)

### *Douglas Howard*

Charles had two younger sisters, Douglas Howard (1545-1608) and Frances Howard (1554-1649). In the summer of 1573 the two caused a scandal at court by showing themselves to be "very far in love" with the Earl of Leicester, Robert Dudley (1532-1588) This caused royal commotion because Leicester was a long-standing favorite of Queen Elizabeth I.

Dudley is thought to have actually married Douglas Howard, for they had a child together, but Dudley deserted her and later married Lettice Knollys. Later (in 1583), Douglas Howard married Edward Stafford who was shortly thereafter appointed Ambassador to France, (and whose chaplain was Richard Hakluyt, the younger.)

### *Francis Howard*

The plot thickens. Robert Dudley also had an affair with Frances Howard, who was only 19 years old in that hot summer of 1573.

Frances' lady-in-waiting was Jane Fromond. The two were about the same age and were close confidants and lifelong friends.

In 1578, Jane Fromond (then age 23) married John Dee (then age 51).

On April 6, 1583, Dee wrote in his diary that he and Kelley were busy with their "work" in his study in Mortlake when Frances Howard burst into the room. She was looking for Jane who apparently was not home, but she stayed for "an hour or two."

Later, in his next scrying session with Edward Kelley, Dee asked if "Mistress Hayward (Gentlewoman of Her Majesty's Privy Chamber)" was to be instrumental in Dee's projects because of "her great charity used toward many (as in procuring the Queen Majesty's alms to many needy persons)." (Dee, in Fenton, p. 64)

Eleven years later, in 1594, after having returned to England from their European journey to a ransacked library (estimated at £400 damage) John and Jane Dee's fell into hard times financial. Dee appealed to the Queen and Court. After much string-pulling, he finally obtained a position as warden of Manchester College.

Jane Dee tried to use her court connections in this appeal for royal assistance.  
Dee reports in his diary:

**“7 Dec. [1584].**

**Jane my wife delivered her supplication to the Q.M.  
as she passed out of the privy garden at Somerset House  
to go to dinner to the Savoy to Sir Thomas Henedge.  
The L. Admiral took if of the Queen &  
Her Matie [Majesty] took the bill again and kept upon her cushion.”**

(Dee, in Fenton, p. 268)

The “L. Admiral” was Charles Howard (of Spanish Armada fame).

In short, Lord Admiral Charles Howard was quite aware of Dee’s influence in conceiving of and promoting a large British Navy and the start of the British Empire.

He was also aware of Dee’s then-popular Monas symbol. I assert that the “fouled anchor” is a cryptic representation of the Monas symbol **combined with** the ideas of “Jesus as an anchor” and “Hope.”

The passage in the Bible (Hebrews 6:19) says nothing of an attached rope, never mind it being “fouled.” Some historians have suggested the rope was merely added for decorative purposes, to contrast the stark geometry of the anchor’s symmetrical shape.

But no one has ever explained why the rope is “fouled” in the first place. “Fouled” suggests there is a problem which doesn’t really fit into the “biblical story” of Hope nor the “naval story” of a strong, organized, well-trained navy.

You don’t have to be a highly skilled graphic designer to see the similarity between the the Monas Symbol and “fouled anchor.”

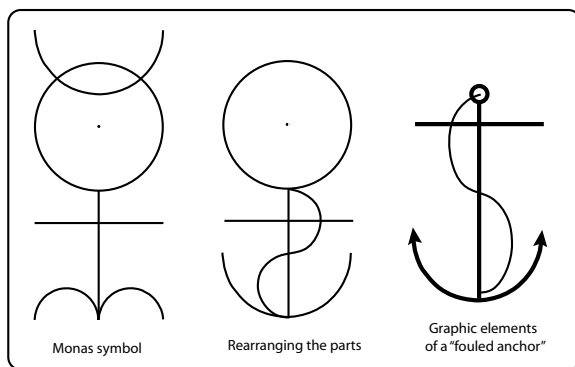

They each have a prominent cross.  
They each have a prominent crescent shape.  
They each have a prominent circle, even though the circle on the anchor is much smaller than the sun circle of the Monas symbol.

But without the fouled rope, the anchor has nothing to represent the Aries Symbol.

Even though the fouled rope is an “S” shape, and the Aries symbol is two “horns,” they are both essentially comprised of two half-circles. Dee himself demonstrates a certain hinged flexibility of these two half-circles in Theorem 21 where he connects them to make a full circle.

The fouled anchor has all the same parts as the Monas symbol, they’re simply re-arranged and scaled differently.

This graphic interconnection is not attributable to Sir Humphrey Gilbert, Charles Howard, or Governor Benedict Arnold, but is clearly, to me, something that came from the mind of John Dee. From my analysis of the *Monas Hieroglyphica*, I have found that Dee is a master at putting something right in front of the reader's nose and it's all but invisible, without some wisdom gleaned elsewhere.

Even though Dee is insistent in Theorem 23 that there is only one correct geometrical proportioning for the parts of his symbol, it would be just like him to cleverly devise what I call a "symbol that stands for a symbol." In addition, the anchor symbol incorporates a strong Christian theme, very important in Elizabethan days.

The Monas symbol, (Dee's one-eyed squatting homunculus made from circles and straight lines in specific harmonious proportions), would not have ever been adopted by the British, U.S., Canadian, and other Navies from around the world. But the anchor is a logical symbol of strength, security, and navigation. The "fouled rope" is but a clue that there is a deeper meaning hidden in the symbol that only a knowledgeable philosopher would ever see.

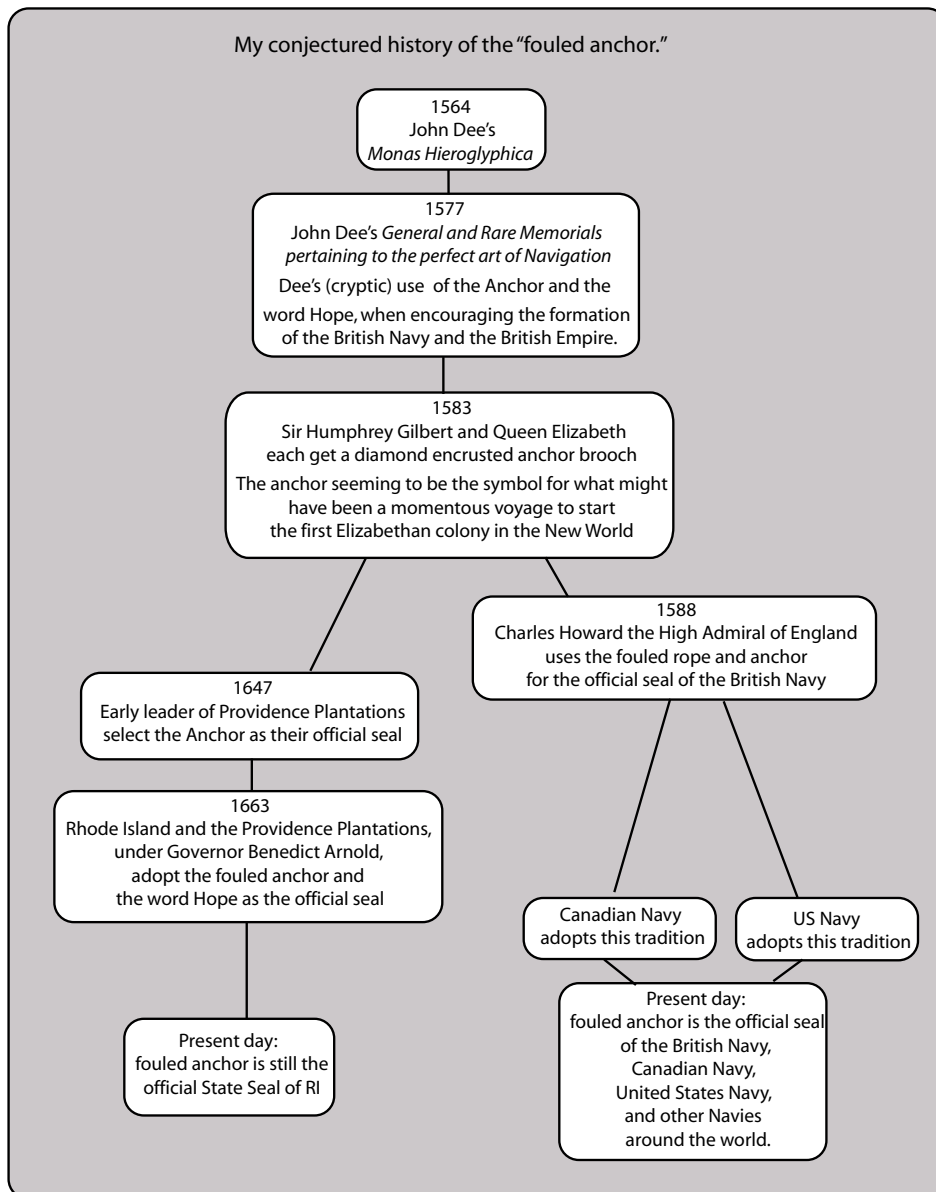

## *Following Dee*

Following Dee, they used the name “Rhode Island.”

Following Dee they used the anchor as their symbol.

Following Dee, Benedict used the solar disc calendar room in the John Dee tower.

They saw that their desire on religious freedom was the same as that of their countryman John Dee 50 years earlier.

The early Rhode Island colonists were living John Dee’s dream. And today we are living the dreams of the Early Rhode Island colonists.

Roger Williams, John Clark, and Benedict Arnold were all keenly aware of John Dee, his building and the failed Catholic settlement project of 1583. Roger Williams wanted to avoid all connections by calling Aquidneck “Patmos.” Newport settlers like John Clark, William Dyer, William Brenton, and later Benedict Arnold wanted to commemorate that tradition, but did it cryptically to avoid any future land claims by other Englishmen and to avoid something in any way associated with Catholicism.

Enthusiasm resurfaced with Sir Walter Raleigh (Gilbert’s half brother), but this time the focus was on Virginia. Even that failed.

Fifty years later, in the 1630’s, different Englishmen settled what was to have been the the utopia Dee had envisioned in his mind (during the 1570’s) at the “John Dee river and port.

”Dee was able to get Sir Humphrey Gilbert, Walshingham, Sir George Peckham and others to buy into his idea of a utopian colony at the John Dee port and river. A preliminary mission to construct the first building. Gilbert had the deed. Peckham had the money. Walshingham helped convince the Queen that a colony where freedom of worship was allowed would solve England’s internal religious unrest. Gilbert and his 5 ships set sail. Unwisely, Gilbert decided to assert himself in Saint John’s Bay Newfoundland first. Disasters ensued. Gilbert drowned. Enthusiasm for the colony dwindled. Dee and Kelley left for Prague.

Dee was much smarter than most of his fellow Elizabethans and he knew it. Call it self-centered if you will, but he felt that his single voice could resolve the Protestant-Catholic clash not only in England, but all over Europe.

Dee felt he had discovered a glorious proof of nature’s harmony (the “Laws ... of the Wisdom of Nature”) in his studies of geometry (print, line, circle to the most basic of shapes, the tetrahedron, to the amazing cuboctahedron ...) and arithmetic (Metamorphosis, Consummata, The Exemplar Number, Nicomachus’ and Boethius’ greatest and most perfect harmony ...) He felt these two mathematical sisters influenced all the Arts and Sciences. He synthesized all this wisdom into his Monas Symbol. He cryptically referenced his Monas symbol by using the more common symbol, the anchor.



# CLUES IN THE TITLE PAGE OF DEE'S GENERAL AND RARE MEMORIALS...

I assert that it was John Dee who conceived of the idea of using an anchor and the word HOPE to represent the British maritime ambitions he so passionately advocated. The one work that explained his expansionist ideas was his 1577 *GENERAL AND RARE MEMORIALS pertaining to the Perfect Art of NAVIGATION*.

Dee has jam-packed many visual clues into the Title page illustration, just as he did in the *Monas Hieroglyphica*. The illustration is not only busy with many different visual elements, but it also looks strange to the modern eye because many of the words are written in Hebrew, Greek, and Latin.

(The title page was printed in two passes through the press. The title is the only part printed in the typesetting pass. All the rest (including the words in the 3 languages) was printed on the engraving pass through the press.)

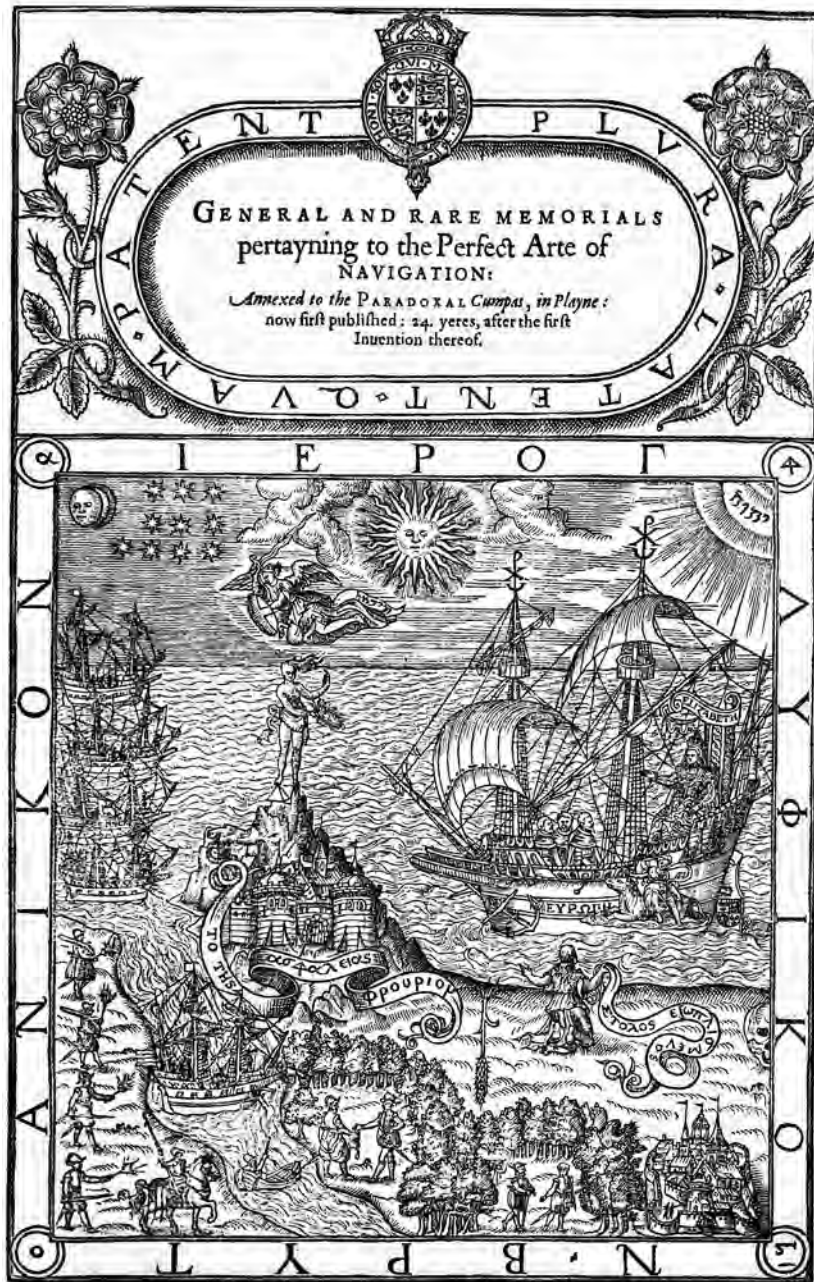

To simplify the analysis of this illustration let's first translate the words.

Around the perimeter of the illustration are the Greek words (starting from the bottom) "BRYTANIKON IEROGLYPHIKON" or a "British Hieroglyphic," or a "Symbol of Britain." Had he written it in Latin, "Brittanica Hieroglyphica," the inference that it is related to the *Monas Hieroglyphica* would be even more obvious. But there doesn't seem to be any Monas symbol, or even any numbers here.

The only thing reminiscent of the *Monas* are the Sun and the Moon, but they are anthropomorphized (they have faces) and don't seem to be the same size. But on closer inspection, if the rays of light are excluded from the circle of the sun, it is the same size as the Moon!

The letters in the lozenge shape around the title spell out PLURA LATENT QUAM PAT-ENT which means "MORE IS HIDDEN THAN OUT IN THE OPEN." Dee is even informing us that there is more to this illustration than meets the eye! What looks like an innocent border design for the title is an orange-neon sign shouting LOOK FOR HIDDEN CLUES!

Instead of using balloons for spoken words (like the comic books and newspaper cartoons of today), Dee suggested spoken words on flowing ribbons. The woman with arms outstretched kneeling on the shoreline is addressing the Queen.

Her words, written in Greek, say, “*stolos exoplismenos*” or “*send forth a sailing expedition.*”

The other ribbon, wrapped about a strong fortress built on a mountain range upon which a scantily-clad woman stands reads, “*TO TES asphaleian phroriam*” which in Greek means “*to make a steadfast watch-tower.*”

The angel hovering over the woman’s head is labeled, in Hebrew, MIYKAEL, or the archangel Michael.

On page 53 of his text, Dee gives a brief explanation of the Title page. In the margin, he has creatively typeset words IEROGLYPHIKON BRYTANIKON running vertically (in Greek, with no space between the two words).

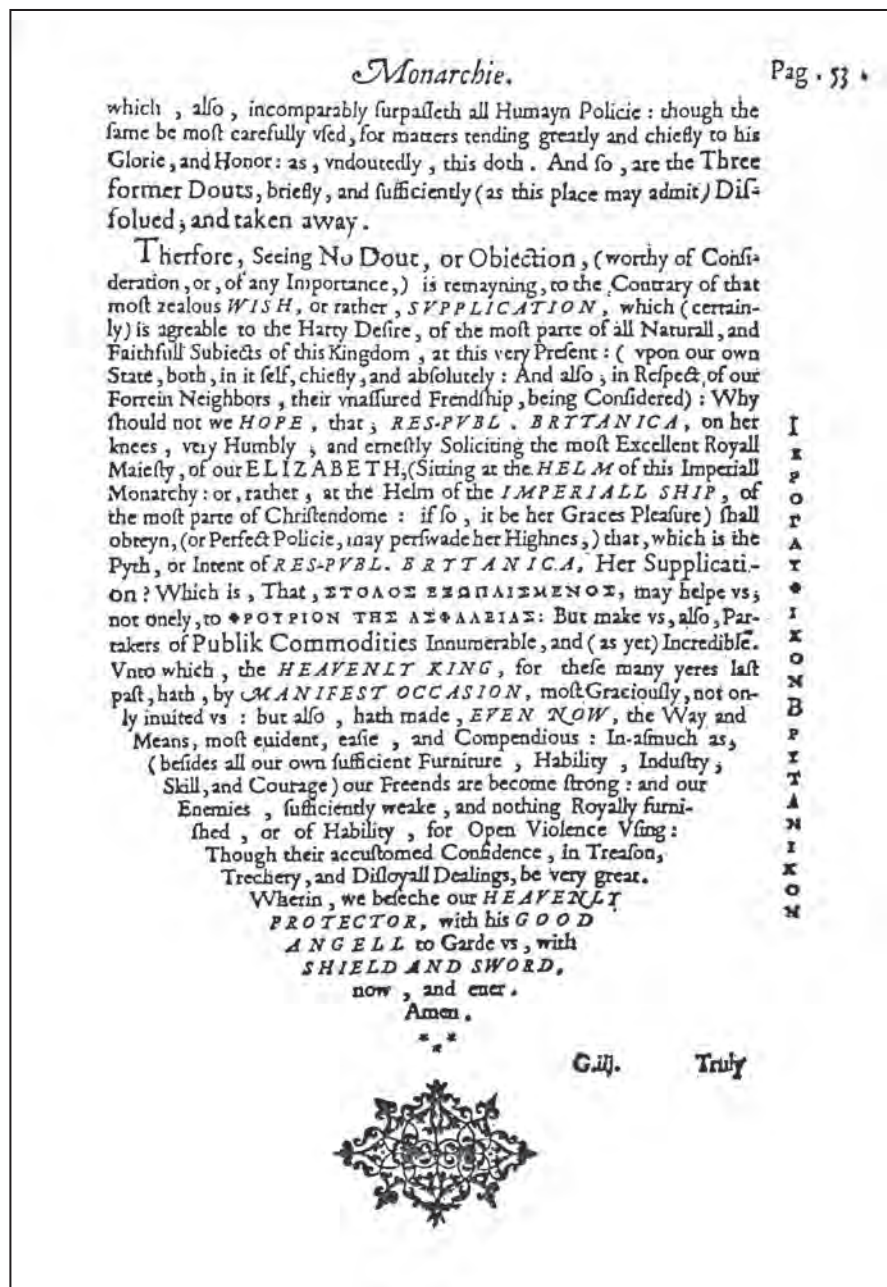



Near the middle of the page, Dee asks rhetorically:

**“Why should not we HOPE that RES-PUBL. BRYTANICA on her knees, very Humbly, and earnestly Soliciting the most Excellent Royall Majesty, of our ELIZABETH, (sitting at the HELM of this Imperiall Monarchy: or, rather, at the Helm of the IMPERIALL SHIP of the most parte of Christendome, if so, it be her Grace’s Pleasure) shall obteyn, (or Perfect Policy, may persuade her Highness) that, which is the Pyth or Intent of RES-PUBL. BRYTANICA Her Supplication?”**

Notice Dee begins with the word HOPE in capital letters

**RES-PUBL. BRYTANICA** means “The British State.”

Pyth means essence.

Then Dee explains those Greek words “spoken” on the Title page:

**Which is  
STOLOS EXOPLISMENOS,  
may help us, not onely to  
PHROURION TES ASPHALEIAS  
But make us, Partakers of  
Publik Commodities Innumerable,  
and (as yet) Incredible.**

[SEND FORTH AN EXPEDITION]

[TO KEEP A STEADFAST WATCH]

Dee is speaking on behalf of the English explorers and merchants eager to tap the many natural resources of the New World.

**Unto which, the HEAVENLY KING [GOD] for these many yeres past, hath by MANIFEST OCCASION most Graciously not only invited us: but also hath made EVEN NOW, the way and Means most evident, easie, and Compendious.**

Compendious means beneficial or profitable.

“Manifest Occasion” means circumstances that are clearly revealed to the eye or mind. This refers to the historical and legal evidence that Dee expounds upon in this book that make Britain’s colonizing efforts and increasing the size of its Naval fleet obviously the right thing to do, immediately.

**“Inasmuch as  
(besides all our own sufficient Furniture,  
Hability , Industry, Skill and Courage)  
our Freends are become strong:  
and our Enemies, sufficiently weake,  
and nothing Royally furnished, or of Hability,  
for Open violence Using:  
Though their accustomed Confidence,  
in Treason, Trechery, and Disloyal Dealings,  
will be great.”**

Dee is like a sports coach  
inspiring his team.  
We’re better, stronger,  
and braver.  
The enemy is weak,  
and unequipped to win.

By “**Freends**” [Friends] Dee is referring to England’s allies in Europe. Next to the Greek word EYROPA on the side of the Queen’s ship is a goddess sitting on top of a bull. The continent Europe was named after the Greek Goddess Europa who was abducted by Zeus after he turned himself into a large bull. The fact that they are somehow attached to the boat indicates they are on Elizabeth’s side.

**Wherein, we beseche our HEAVENLY PROTECTOR  
with his GOOD ANGEL to Garde us,  
with SHIELD AND SWORD now, and ever, Amen.”**

This “protector” is  
the archangel Michael,  
who is commonly  
portrayed with  
a sword and shield.

### *A spiral tour of the Title page*

Having described most of the main characters, let’s “read” the story Dee is telling, starting with the kneeling figure, going up, spiraling around to the left, and then down the river to the bottom.

The kneeling woman, representing of the people of Britain saying “send forth an expedition,” is directly facing the Queen, who sits on her throne on the poop deck (sorry, that’s what it’s called) of her galleon, the ship of state. She is gesturing orders to the 3 anonymous Courtiers or Explorers with her right hand, while her left hand steers the ship with the the tiller. On the rudder, just above the waterline is a decorative shield (and above it is the rudder’s hinge).

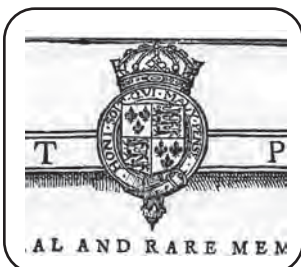

This same shield is prominently displayed in the emblem at the top-center of the Title page. The first and fourth quadrants of the sheild each contain 3 “fleur-de-lis” shapes. (This lily flower is most often associated with French emblems, but it actually dates back to Roman times.) The second and third quadrants each contain 3 stretching lions. The shield is encircled by a buckled belt emblazoned with the words “HONI SOIT QUI MAL Y PENSE.” This is the shield and motto of the highest English order of chivalry, the Order of the Garter.

The story goes that King Edward III, (who made England the strongest military power in Europe during his 50-year reign from 1327-1377), was dancing with or near the Countess of Salisbury at the Palace Ball. When her garter accidentally slipped off her leg, several courtiers snickered, and she was embarrassed. The chivalrous King picked it up off the dance floor and attached it to his own leg, saying (in Old French) “Honi soit qui mal y pense,” meaning “Shame on he who thinks evil of it.”

Dee’s depiction of the shield and garter is surmounted by the Queen’s crown. The connection is obvious. The Queen controls the rudder which is her highest ranking courtiers (the gentlemen aboard her ship), and they run the ship of state according to her wishes. (It’s interesting that Buckminster Fuller’s “Call me trimtab” motto also involves the metaphor of a rudder.) Alongside the ship are the Queen’s allies, symbolized by Europa astride her bull. The Greek letters EUROPH seem to spell out EUROPA, except the last letter, half concealed by the bull’s front leg, looks more like an H than an A. (A clue we will return to momentarily.)

At the bow is a large anchor securely fastened to the hull. (Another important clue.)

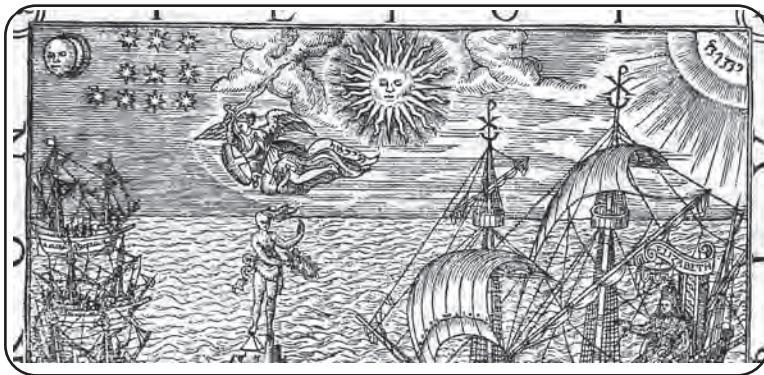

The sky is festooned with various objects. The profuse rays in the upper-right-hand corner are not the rays of the sun. They are Dee’s representation of God. The Hebrew letters are YHWH, the Tetragammon (*Tetra* means four and *gammon* means letters letters), the unvoiced Hebrew name for God. Graphically, God’s radiant force is filling the sails of Elizabeth’s ship with wind power.

### *Lady Occasion*

Dee provides several clues about who the lady on the mountain is and what she is doing.

On page 54 he writes:

**“But, yet, (said he) there is a Little lock of LADY OCCASION,  
Flickering in the Air, for our hands, to catch hold of,  
whereby we might once more  
(before all be utterly past and gone forever)  
discretely and valiantly recover and enjoy,  
if not all our Ancient and due Appertenances, to this ImperialBritish Monarchy,  
yet, at least some such Notable Portion thereof ...”**

Similarly, on pages 63-64, after explaining that no other Kingdom has the Timber, Shipwrights, Harbors, courageous Gentlemen, and Human Industry that Britain has, he summarizes:

**“And (To be brief) Seeing No Kingdom is more Discrete,  
and willing to Use the \* Opportunity  
of any exceeding great and Public Benefit procuring the same,  
then this British Monarchy, is, or May be ...”**



Dee's asterisk references his note in the margin:  
 “\***FRONTE Capillata, post, est Occasio, Calva.**”  
 which means

“On the forehead, Occasion has hair, on the back part, she is bald.”

The metaphor of “seizing opportunity by the forelock”  
 goes back to the Greek and Roman poets  
 like Phaedrus, Ausonius, and Cicero.  
 In Dee's time, this adage was quite well known.

Marlowe writes (in 1592), “Begin betimes, occasion's bald behind.” (*OED*, Occasion, p. 1970)

Shakespeare, in *Othello*, writes “To take safest occasion by the front.”

And Milton writes “But on occasion's forelock watchful wait.”

(John Todd, *Poetical Works of John Milton*, p. 167)

Just as Dee has depicted her, Lady Occasion is seen as bald, with one lock of hair just above her forehead. Dee's Lady Occasion is even gesturing at her forelock as if she is saying to the Queen “Seize the opportunity and you will win the crown of victory I hold in my other hand.”

Around 1500, Renaissance artists like Marcantonio Raimondi portrayed Lady Occasion with her foot poised upon a globe. Dee seized the opportunity to give her his own geometric spin, by having her stand on his beloved tetrahedron. Not only does the white tetrahedron seem strange in the midst of all these textured natural objects, it's awkwardly unbalanced on a mountain peak and its tip (point) certainly must not be comfortable for the barefooted Lady Occasion. Because the back of the tetrahedron is hidden from view, it might be a “4-sided plus base” (Pyramid of Giza) shape instead.

Perhaps Dee as being intentionally ambiguous here so the reader will consider both shapes. And indeed, the geometric figure which is comprised of these two shapes is the cuboctahedron, with 8 tetrahedra, symmetrically interlaced with 6 “Pyramids of Giza.” Its 8 triangular faces and 6 square faces (or the 4:3 ratio) relate to Dee's maxim “Quaternary rests in the Ternary.”

Lady Occasion is specifically pointing to the forelock which is on the horizon line of the vast ocean. This horizontal line is exactly  $\frac{3}{4}$  of the way up from the bottom of Dee's illustration. In other words, the ratio of the “Land plus Sea area” to the “whole illustration” is 3 : 4. This is no accident; it's Dee's clever concealment of one of the most important mathematical tenets of the *Monas Hieroglyphica*. Pushing the imagination a little bit further, we might simply see Lady Occasion standing on a cuboctahedron. (Bucky would surely smile about this.)

## *Continuing the tour through the sky*



In the exact center of the upper sky, breaking through the clouds is the Sun. It's no accident that the sun has 24 rays. And notice that 12 of them are straight and 12 of them are wiggly, like heat waves seen in a mirage.



Just as the real-life sun and moon appear to be the same sizes as seen from Earth, and just as the Sun and the Moon of the Monas symbol are the same diameter, Dee made the sun and moon in the sky of this Title page the same size. Ignoring the 24 rays that make it seem expansive, the central circular part of the sun is the same diameter as the moon.

You can tell Dee thought a lot about how to depict the moon. The female moon must have a face like its counterpart, the male sun.

The “Man in the Moon” face, or more properly here the “Woman in the Moon” face, created by dark “seas” and lighter toned highlands has been seen for a long time. Over 19 centuries ago, Plutarch (ca. 46-120 AD) wrote a treatise entitled “*On the Face Which Appears in the Orb of the Moon.*”

The face is distinguishable when the moon is full or nearly full—but graphically, a white-filled circle with a face would simply look like another Sun. The best shape to express “Moon” is the crescent—but the “face on the Moon” isn’t visible when the Moon is crescent shaped.

To resolve this visual dilemma, Dee made the bright face somewhat grey, with a border. The result is a strange-looking moon, that combines crescentness and roundness, but still clearly says “Moon”

## *The Ten Stars*



Stars are generally distributed much more randomly than the organized way Dee depicts them. Orion’s belt might have 3 in a row, but no constellation has a 3 X 3 grid of 9 stars with a tenth star off to the side.

They might be planets, but to the ancients as well as the Elizabethans, there were only 7 planets, and besides two of them were the sun and moon, already depicted here. There are clearly a “decad” of stars.

Tenness is a huge them in the *Monas*.

In Theorem 8, referring to Roman numerals, Dee writes:

**“It is not without reason that the Oldest Latin Philosophers  
decided to signify the number TEN  
by using Rectilinear CROSS made from 4 Straight lines.”**

And in Theorems 6 and 20 he makes a big deal about the “point” in the center of the cross which is “**there**” in the Ternary but “**not there**” in the Quaternary.



If a giant X is drawn across Dee's illustration, from corner to corner, that central "point" falls precisely at the "point" of the bow of Elizabeth's galleon.

Dee wanted us to see tenness, but not in the Pythagorean  $1+2+3+4=10$  "tetractys" arrangement. He chose a  $9+1=10$  arrangement reminiscent of the final round of the maxim on the flowing ribbons on the title page of the Monas.

Mercurius (7)+1=8      Mercurius (8)+1=9      Mercurius (9)+1=10.

To Dee, 9 was the Horizon Number, and the grid of 9 stars is not far from the illustration's straight horizon, where sea meets sky.

If you look closely there's another numerical connection between the grid of 9 stars and the Monas. Each star has 8 rays, so the grid of 9 stars has 72 rays in total.

Between the 12 straight rays plus the 12 wiggly rays of the sun (totaling 24 rays), and the 72 rays of the 9 stars in the grid, Dee has cryptically expressed the first 3 Metamorphosis numbers. (Remember, these three add up to 108 ( $12+24+72=108$ )). To reach the next Metamorphosis number, 360, the number of rays required would be 252, Dee's Magistral number. All this, of course, would be invisible to anyone who didn't know the secrets of the *Monas Hieroglyphica*.)

### 4 ships and 4 fire-wielding gentlemen

Along the left edge of the illustration are 4 ships and 4 men brandishing weapons and flaming torches. They don't appear to be torching the land. Perhaps it's meant to be a scare tactic, but there don't appear to be any enemies around. I think Dee wants us to see these men as "pyrologists," not in the sense they deal with fire, but in the sense Dee uses in Axiom 18 of the Propaedeumata Aphoristica, where he writes, "**Pyrologians will understand what I mean.**"

The latter half of that Axiom deals with 1, 2, 3, 4 and their interrelationships 1:2, 2:3, and 3:4. (the ratios found in Nicomachus and Boethius greatest and most perfect harmony, and in the proportions of the 3 key illustrations in the *Monas*.)

Labeling these fire-wielding gentlemen from the bottom, 1, 2, 3, 4, and the 4 ships 5, 6, 7, 8 makes an **octave** of objects on land and sea. Above the horizon line is the curious grid of 9 stars. Does this remind you of something? It's the same arrangement as the left edge of the "Thus the World Was Created" chart. It's an expression of Consummata!

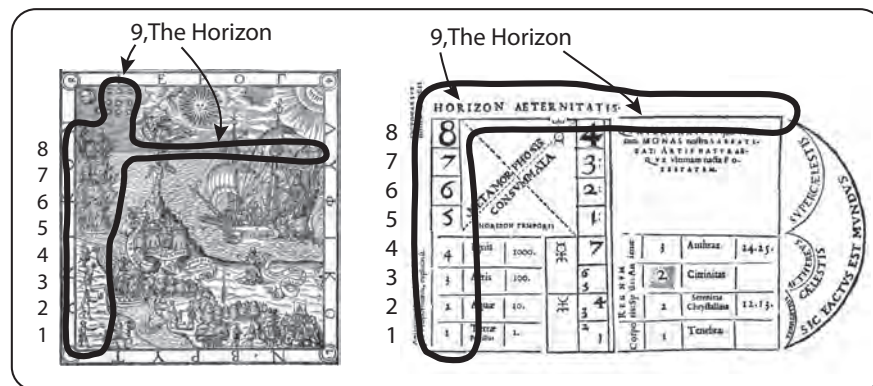

Dee's sky expresses the Metamorphosis sequence, the left edge expresses Consummata, and both depictions "share" the use of the grid of 9 stars.

This is befitting because 72 is a very special number. Not only is it a Metamorphosis number, but also a member of the 9-wave of Consummata (9, 18, 27, 36, 45, 54, 63, 72, 81, 90, ...).

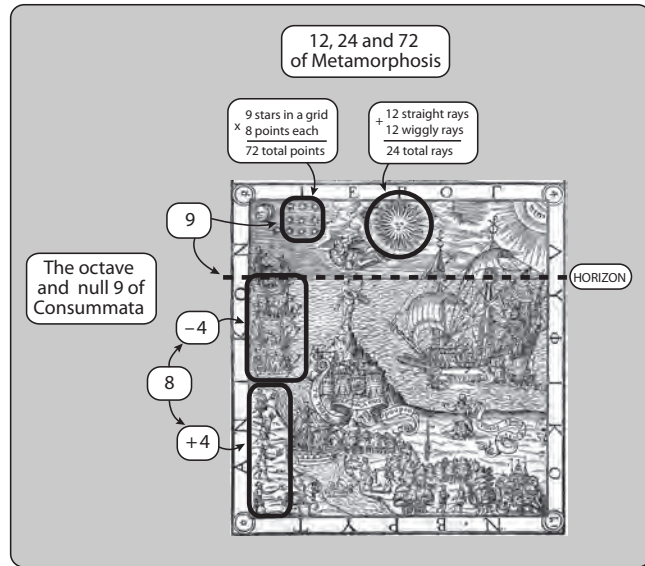

### The 42nd of 72 angels

Furthermore, in "Thus the World Was Created" chart, Dee geometrically associates 72 with the "Supercelestial" region, the realm of the 72 Angels.

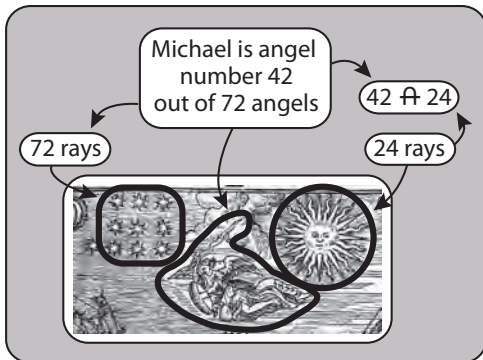
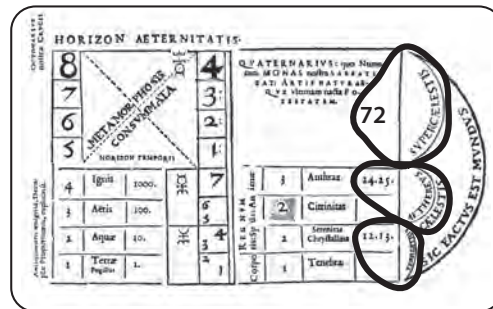

And appropriately, next to the grid of 9 stars and their 72 rays is the angel Michael.

Even more appropriately, in the list of the 72 Angels, Michael is number 42, which is the reflective mate of 24, the number of rays in the sun.

Dee emphasizes this connection by writing Michael in Hebrew and placing it on a banner that almost touches the rays of the Sun.



### More on the 4 pyrologians

Dee's beloved Plato equated the tetrahedron with the element of fire. Thus these 4 pyrologians are symbolically related to the tetrahedron under Lady Occasion's foot. (*Pyr* is the Greek word for fire.)

They also relate to the beginning part of Axiom 18 of the *Propaedeumata Aphoristica*, where Dee says:

**“In each of the 4 separate, great Wombs of the Larger World are three different parts.”**

As explained earlier in the analysis of Aphorism 18, these Wombs are the four pairs of tip-to-tip tetrahedra in the cuboctahedron.

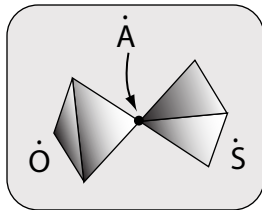
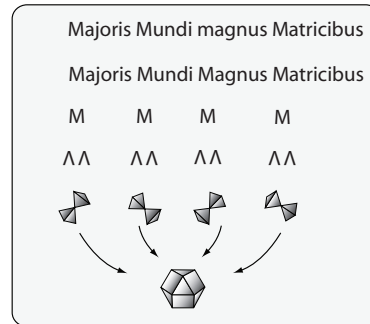

Dee also (cryptically) explains that the “**three different parts**” of each of these “Bucky Bowties” are Ö, Ä, and Š,

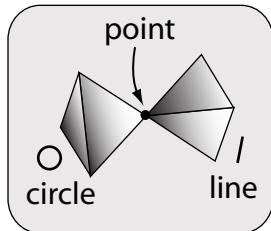

These are Dee's code letters for circle, point, and line.

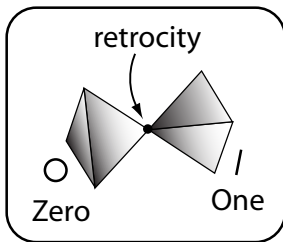

Another way to see this is “zero-retrocity-one,” where the circle and the line are two “opposites,” joined by the point, “retrocity.”

This is what Marshall calls the Prenumerical Singular Tertiary, “**zero-retrocity-one**” or for short, “**zero-one.**”



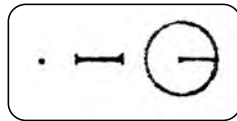

Dee explains in Theorem 2 not only do “Things come into being by way of the point” but the circle and line could not exist without the point.

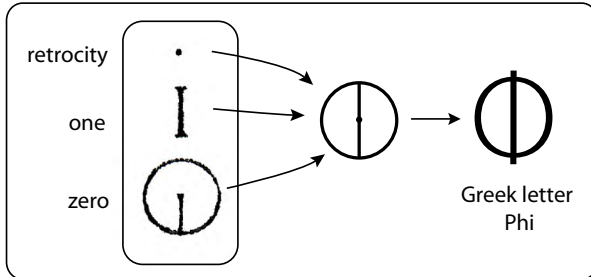

One graphic way of expressing of combining these three geometric things is to symmetrically superimpose them, making a circle with a vertical line through it, like the Greek capital letter Phi.

(Dee hints at this shape in on page 5 of his *Letter to Maximillian* when he dicusses the “IOD and the chireck.” He describes a “Trinity being Formed from One straight line and Two different parts of the circumference.”)

Aphorism 18 of the *Propae-deumata Aphoristica* (written by Dee in 1568) might seem unrelated to this busy nautical scene on the Title-page of *General and Rare Memorials* (drawn in 1577).

But Dee has included O, A, S, and  $\Phi$  (or circle, point, line, and “zero-one”) in the 4 corners of his illustration!

On the upper left is a lowercase Greek alpha ( $\alpha$ ), in the lower left is a lowercase omicron ( $\omicron$ ), and in the lower right is a lowercase sigma ( $\varsigma$ ).

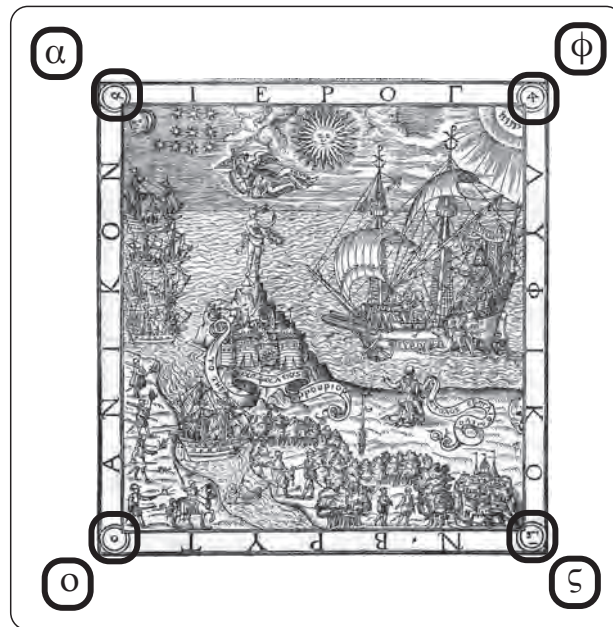

The top of the sigma is even stylized to look like a line, with small serif at the end. (Dee uses similar short serifs in the illustration of a line in Theorem 2 of the *Monas*.) (The horizontal line underneath the sign may be to indicate that it is not meant to be rotated.)

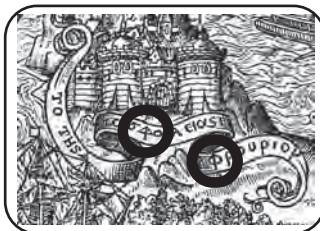

On the upper right corner is a stylized lowercase phi. Dee has further disguised it to look like a triangle on a stem, but it’s definitely a letter “phi,” as Dee uses the same letter shape in the word ASPHALEIAS (steadfast, sure, certain, firm) on the ribbon that swirls around the fortress on the mountain. (As a further clue, Dee uses a normally shaped letter phi in the next word, PHRYRION)

These 4 letters would obviously be a confounding puzzle to anyone who did not understand Axiom 18. Remember that point, line, and circle are the three things Dee introduces in the very first two Theorems of the *Monas Hieroglyphica*, the title of which means Symbol of One-ness.

Throughout his works (from his 1558 and 1568 *Propaedeumata Aphoristica* to his 1564 *Monas Hieroglyphica* to his 1570 *Preface to Euclid* to his 1577 *General and Rare Memorials*), Dee presents a consistent cosmology, but he reiterates clues in slightly different ways. (Thus it is not surprising to find his cosmology expressed in the John Dee Tower as well)

***Let's return to our spiral tour of the illustration.***

In the middle of the flowing river is another galleon, anchored, with sails down, like the other four ships out in the ocean. Further upstream is an explorer on horseback, one in a rowboat, and one on the other side of the river exchanging goods with another character. These figures flow so naturally from right to left, they appear to be either the same person in motion, or at least members of the same mission. The trading deal takes place in a small clearing surrounded by trees.



Further to the right is another small clearing with two similar characters that seem to be walking and gesturing even further to the right. These two “walking” characters are drawn on a slightly smaller scale than the two “trading-deal” characters.



Even further to the right beyond a thick grove of trees is a depiction of a walled town with horses and buildings with spires. Walking in the city are two more characters drawn at an even smaller scale.



In short, there is a flowing sequence (like frames in a movie) from the “4 pyrologians,” to the “knight on horseback,” to the “rower,” to the “2 trading-deal characters,” to the “2 walking characters,” to the “2 men in the walled town.” The walled town is tucked into the lower right hand corner of the picture. Just above it is the “send Forth an expedition” ribbon of the kneeling supplicant, where our spiral of the title page started.)

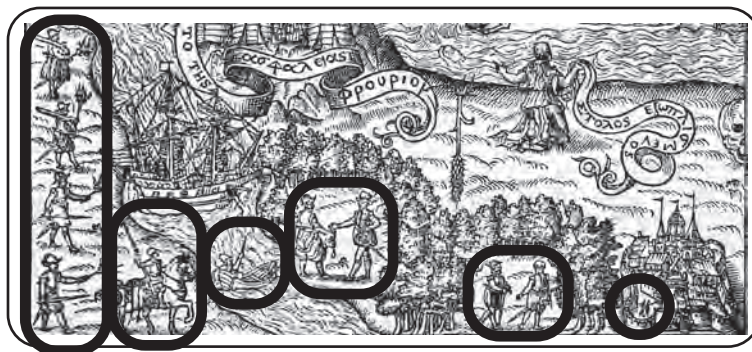

Let's zoom in for a close-up of the town. There appear to be about a dozen buildings. Most appear to be houses, but two of them are larger and are topped with pointed spires as if they were churches or administration buildings.

But way up at the very top is a building with a dome topped by a finial with a flag. Below the dome are three columns. And below these columns are what appear to be four supporting pillars.

This domed structure, I believe, is the John Dee Tower. (And it may just be the only representation of the Tower in existence.)



There are only 3 upper pillars visible, suggesting one is hidden, making 4 pillars (or perhaps 3 are hidden making 6 pillars). While this is unlike the John Dee Tower, where from any given viewpoint 4 pillars are visible and 4 are hidden, making 8, a little artistic license might be allowed as the town is drawn in such a small scale (like the way cartoonists visually simplify their characters' hands with 3 fingers and a thumb).

Though Dee did not personally engrave the final plate from which the Title page was printed, he provided the artist with a very detailed drawing to work from (still in existence) and was very particular about the smallest details of everything in it.



Not only is the Tower “up on a hill” overlooking the town (like the Tower in Newport), but it's also the culmination of the whole “spiral tour” that circles around Lady Opportunity. From the kneeling supplicant, to Elizabeth's galleon, to the various figures in the sky, to the 4 galleons, to the 4 Pyrologians, the traders, the walkers, the men in the city, the flow ends with this domed structure.

As we've seen, Dee based the design for the John Dee Tower on the mathematical ideas he presented in the *Monas Hieroglyphica*. In the sky of this title page illustration Dee has shown the **Sun and Moon** of the *Monas*, but they also appear cryptically in another way.

**Can you find them?**



As Dee told us in Theorem 4, the Moon “longs for” the Sun so much that “she becomes Transformed into him.” The female Moon and the male Sun are same-sized circles.

The lozenge shape that surrounds the book’s title is actually based upon two tangent circles. Look how the Order of the Garter emblem “wedges” nicely between the circles

Directly beside the circles, weaving through the “handles” of the lozenge shape are two flowers. The thorns, the buds, the leaves and the 5 petaled symmetry all suggest they are roses. In the alchemical tradition the white rose represents the female, Lunar principle and the red rose represents the male, Solar principle.

(Dee alludes to this in the “Thus the World Was Created” chart where Lunary things are associated with the Crystallina, White stage of the alchemical process and Solary things are associated with the Anthrax, Red stage).

The opened blossoms of these two roses are in the same place on this Title page as the rose plants in the shiny urns are on the title page of the Monas Hieroglyphica. (One might even imagine that Dee plucked them from those very urns.)

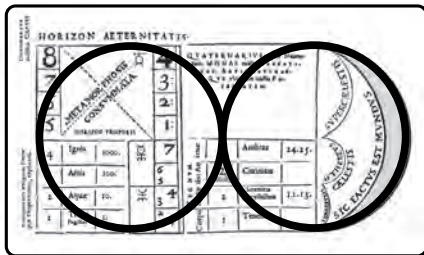
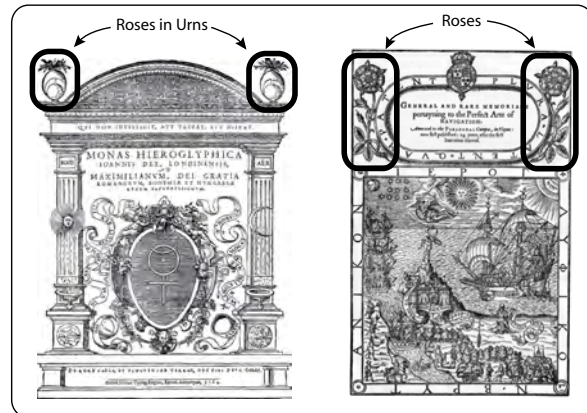

Remember that the “ballooned 360” version of the “Thus the World Was Crated” chart was also based upon two circles. And Dee’s Artificial Quaternary “wedges” “nicely between the two circles

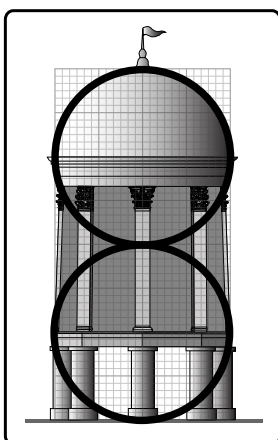

And most importantly, the overall design of the John Dee Tower was based upon two tangent circles (actually on two tangent spheres.)

The graphic way that the lozenge shape disguises the two circles (with straight lines on the top and the bottom) is similar to how the Tower design disguises the two circles (with its straight sides.)

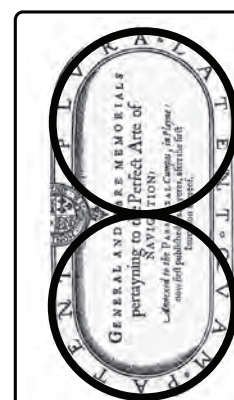

In Dee's mind all these themes, sun and moon, two tangent circles, lozenge shape, tower design were all expressing the same thing, the idea of "oppositeness."

Seen visually, it adds a whole new dimension to Dee's illustrated "story" that spirals around and culminates in the John Dee Tower in the walled town. Thus, the lozenge shape on this "send forth an expedition" Title page is a cryptic blueprint for the Tower. It's like zooming in on the tiny tower in the walled city and enlarging it for a close-up view.

Dee used the idea of hiding a building in the minute detail on the Title page of the *Monas* where he depicted an "althalamos" or a small camera obscura tholos (in the circle representing the element of water on the pedestal of the left pillar.) The essence of that "althalamos" is the aperture or hole, which Dee shows larger, front and center, being emphasized by the pointing tips of the two Mercuries' spears.

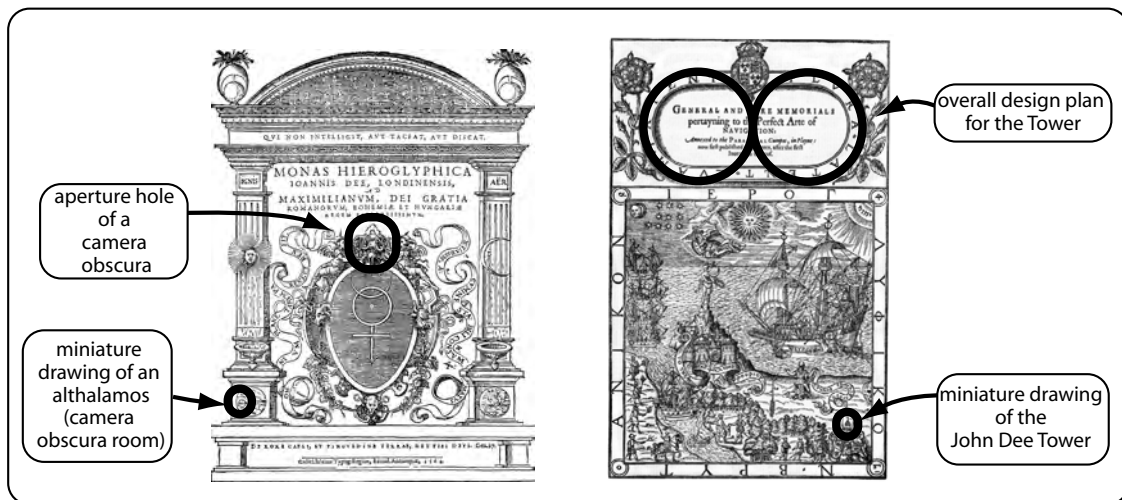

*You have probably noticed several more symbols that we haven't yet reviewed.*

On the lower right edge of the picture lurks a human skull, cut off symmetrically along its midline. To me, this represents the dangers inherent in complacency. By not taking action, England would run the risk of being taken over by a foreign power. If its populace didn't die, their national spirit certainly would. This morbid symbol of human death serves as a contrast to heightened prospects of prosperity if the Queen actually did "send forth an expedition."



In particular, the skull seems to be the antithesis to the inverted wheat plant, drawn at the same level, just on the other side of the kneeling supplicant and her flowing supplication.

Dee makes a reference to wheat on page 64 of the text, where he cites Psalm 147, first in Latin, then in English:



**Lauda HIERUSALEM Dominum,  
Lauda Deum tuum SION.  
Quoniam confortauit Seras Portarum tuarum:  
Benedixit filijs tuis in te.  
Qui posuit fines tuos PACEM,  
Et adipe Frumenti fatiat te. &  
Non fecit Taliter omni Nationi.**

O Hierusalem, prayfe the Lord:  
 Prayfe thy God, O Syon.  
 For, he hath Strengthened the Barres of Thy Gates,  
 And hath bleffed thy Children within thee:  
 He hath made all thy Borders PEACE:  
 And with the good Nutriment of wheat,  
 doth fatiffy thee. &  
 He hath not done thus, to euery Nation, els :  
 Prayfe we all, the Lord therefore.  
 Amen.

Note that he spells Jerusalem with an “H” in both the Latin and English version. This is a commonly used spelling, but it was also frequently written “Ierusalem,” without the H. In Theorem 23 of the *Monas Dee* does just the opposite. He spells Jesus Christ as “Iesu Christi” when sometimes it is spelled with an H, “Hiesu Christi.”

For the word “wheat,” Dee uses the Latin word *Frumenti*. Wheat is a symbol of prosperity, fertility, or bounty of the earth, but here in the context of a psalm and words like Jerusalem, Peace, and Lord, it seems to symbolize the bread or host, the body of Christ in the Eucharist. But neither of these definitions seem quite right. If the wheat symbolized the bread or host, where is the wine, the blood of Christ? And besides, one wheat plant, that can barely make one loaf of bread, doesn’t exactly express “bounty” . A more appropriate, commonly used, symbol would be a whole sheaf of wheat.

A single wheat plant seems to have a slightly different meaning, which still relates to Jesus Christ. It is a symbol of resurrection, based on this passage from the New Testament:

**“Unless a grain of wheat falls in the earth and dies,  
 it remains just a single grain, but if it dies it bears much fruit.”**  
**“Most assuredly, I say to you, unless a grain of wheat  
 falls into the ground and dies, it remains alone;  
 but if it dies, it produces much grain.”**

If a grain of wheat ends up in the corner of the granary floor and never is planted, it will remain as a single seed. But if it is planted in the earth, gets somewhat dissolved, and transforms into a full wheat plant, it will produce hundreds of new seeds, that can likewise produce thousands more, etc.



Presumably Dee didn’t draw one seed because wheat seed doesn’t provide many graphic clues to what it is. It might be mistaken for any kind of seed, or even an egg or a cocoon. But a single plant has roots, stem, leaves, and a distinctive head.

The single wheat plant as a symbol of resurrection certainly contrasts with the half skull symbolizing the death. But why is it upside down?

The answer involves the Biblical citation (book name, chapter number, verse number) from which this wheat quotation comes. I did not mention it earlier because it’s such an incredibly meaningful clue

## It's from John 12:24.

Here we have Dee's first name along with two of his favorite numbers!

In Theorem 11, where Dee explains that on the equinox there are 12 hours of daylight and 12 hours of darkness in the exactly 24 hour day, he adds this “denotes our most Secret Proportions.” Twelve is that wonderfully divisible “docena,” the first Metamorphosis number.

Twenty-four is the second Metamorphosis number, the 24 permutations of four things, 24 karats, and the 24 wings of the animals, the 24 Elders on 24 seats mentioned in Theorem 24. More importantly, in the “Vessels of the Holy Art” diagram of Theorem 22, 12 is the letter M, which is one arm of the cross, the radius of the Sun and Moon Circles. This makes the diameter of the Sun and Moon circles 24.

And Dee is as prolific as a graffiti artist in putting his name (or a code name) on things. (like the “crustaceon”, the “Δ”, or the “John Dee river and port”)

So, in a symbolic (and very Dee-ish) way, the single wheat plant, or John 12:24, is a cryptic representation of Dee's beloved Monas symbol! This explains why it is upside down.

Dee finds it perfectly acceptable, (indeed, even imperative) to invert the Monas symbol. In Theorem 21 he (cryptically) associates its three “anatomical parts” with the Father, Son, and Holy Spirit. (The inverted Lunar crescent representing the Son is at the bottom, just as the grains on the inverted plant are at the bottom.)

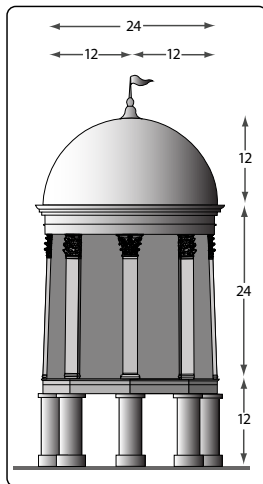
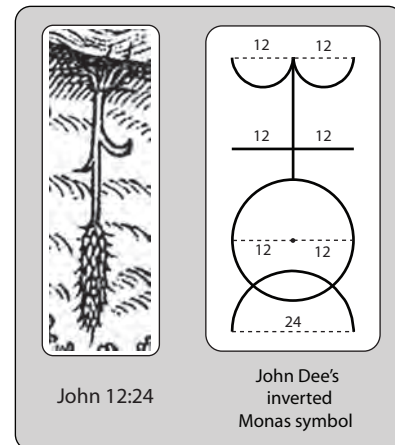

Let's not forget two other places the 12 and 24 show up. It's found 12 around 1 pattern of closest packing of spheres, making a cuboctahedral shape, which has 12 radiating vectors and 24 outer edges (and all being the same length.)

And it also occurs in the John Dee Tower in terms of “feet.” The diameter of the lower entablature (which is 12 feet above ground level) is 12 feet. Its diameter is 12 feet. The radius of the dome is 12 feet, its diameter is 24 feet. Dee weaves a cleverly tight web.

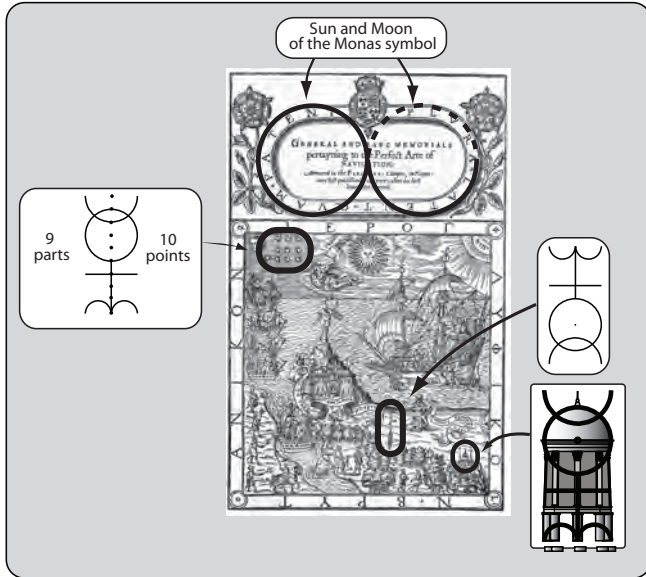

The inverted wheat plant is a “symbol of the Monas symbol,” but it’s not the only “symbol of the Monas symbol” in this illustration.

The tiny depiction of the John Dee Tower is a “symbol of the Monas symbol.”

The Sun and Moon circles in the “lozenge shape” are a “symbol of the Monas symbol.”

The ten stars, organized as a group of 9, plus one single star is a symbol of the Monas symbol in the sense that its spine is geometrically constructed from either “10 points” or “9 parts.”

In a very general way, we might combine the Sun and the Moon in the illustration with the giant X (Cross) made from two diagonals that meet at the bow of Elizabeth’s ship.

The only part missing is the Aries symbol, but this can be inferred from the position of the rising (or perhaps setting) sun. It’s exactly in the midline of the illustration, just as the sun rises exactly in the east on the spring equinox, the first day of Aries. In this creative way the whole illustration might be considered a “symbol of the Monas symbol.”

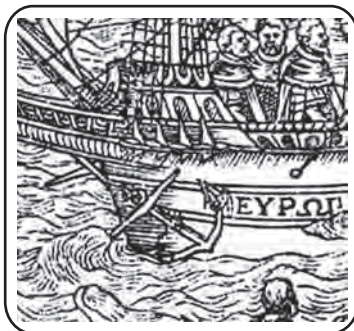
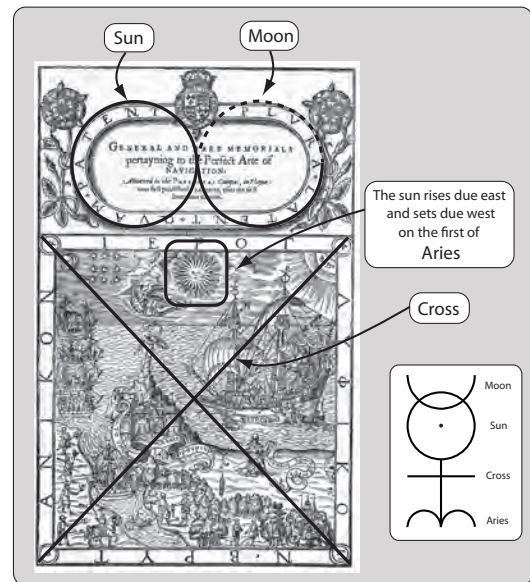

But there’s one other item that suggests Monas-symbol-ness:  
**the anchor.**

Its shank and stock form a Cross-shape, its arms form a semi-circle like a crescent Moon, and the ring at the top is a circle like the Sun. Only the Aries symbol seems lacking here.

In the midst of all this Christian symbolism, most certainly Dee saw this anchor as more than a heavy grappling hook that holds a boat from drifting.





# THE EARLY HISTORY OF THE CROSS

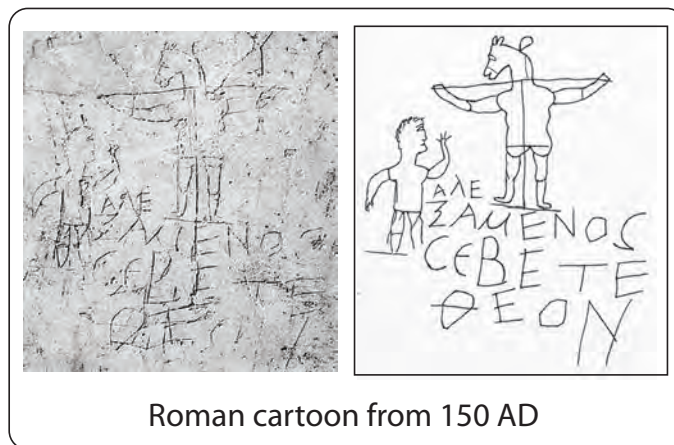

Up until about 300 AD, the cross was used for private devotion. The Romans would ridicule, persecute, and even execute Christians who were too vocal about their beliefs. One example of this can be seen in a satirical “cartoon” from around 150 AD. It has survived because it was scratched in the plaster in a beam of the Roman Paedagogium, the school for the Emperor’s page-boys.

It depicts a man praying next to a crucified man with the head of an ass. Underneath are the Greek words “**Alexamenos sebeta theon**” or “**Alexamenos worships God.**” Nearby, in a different handwriting is what appears to be a response to the insult: “**Alexamenos the faithful.**”

*(New Catholic Encyclopedia, Cross, p. 378; Early Christians.org, p. 1)*

Some early Christians marked their faith with the sign of the cross on their foreheads. The pagan Romans ridiculed them as “Cross-worshippers,” adding “id colunt quod merentur,” meaning “they worship what they deserve.”

(Marucci, O, *The Catholic Encyclopedia Archaeology of the Cross and Crucifix*, Vol 4.)

To celebrate their faith in a way that would avoid persecution, the Christians disguised the cross. The “most frequently employed” was the **anchor**.

The anchor cross is often referred to as a “Crux Dissimulata” or “Disguised Cross.” (Dis-sim-ulo means to hide, conceal, keep secret, or assume another form.) (Luiningman, *Symbols*, p. 118)

The anchor metaphor derives from the Bible, in Hebrews, Chapter 6, verses 18-20:

**“... the hope set before us,  
which we have as an anchor of the soul,  
both sure and steadfast,  
and which entereth into that within the veil,  
where the forerunner is for us entered,  
Jesus, made a high priest for ever ...”**

In short,

**“Hope is an anchor of the soul.”**

In this Christian sense, hope is not about “earthly hopes,” but more about “heavenly hopes.” The New Catholic Encyclopedia writes that it is “hope in the future existence,” “hope in the salvation assured by Christ,” or “hope in life eternal.” (*New Catholic Encyclopedia*, anchor, p. 396)

### *The anchor cross is sometimes called a St. Clement’s Cross*

Pope St. Clement who lived around 100 AD, was even banished by the Roman Emperor Trajan. He was shipped on a boat around Greece and up to the top of the Black Sea to work in the stone quarries of what is now the Ukraine. He and his fellow prisoners worked in harsh conditions, with very little water to drink, so St. Clement knelt down to pray.



Martyrdom of St. Clement  
by Bernardino Fungai  
(Sienna, Italy, ca. 1500)

In his moment of contemplation he noticed a lamb, high up on a hill. He went to where the lamb stood, started digging and found a fresh water spring that provided water for all. When the prisoners and members of the local community witnessed this miracle, they all started converting to Christianity.

This didn’t sit well with the Romans, so they tied St. Clement to an anchor and threw him into the Black Sea. St. Clement became the patron saint of blacksmiths (who made anchors) and the anchor cross was often called “St. Clement’s Cross.”

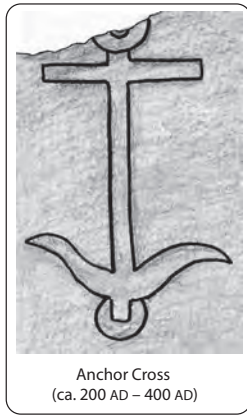

Anchor Cross  
(ca. 200 AD – 400 AD)

From about 200 AD to 400 AD, the anchor occurs frequently on Christian gravestones. Because early cemeteries were located underground, these inscriptions not worn by the elements. They can still be seen today in the catacombs of St. Calixtus, St. Domitilla, St. Pricillia, and the Coeemerium majus (all in Rome).

Sometimes the cross beam was left off to further conceal the anchor's graphic intent.

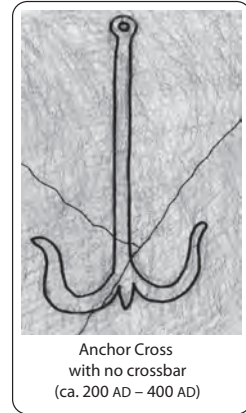

Anchor Cross  
with no crossbar  
(ca. 200 AD – 400 AD)

In St. Priscilla alone, over 70 anchor symbols have been found. The earliest ones (from 100 AD to 200 AD) are associated with expressions like *pax tecum*, *pax tibi*, or *in pace* (all meaning "peace"). The Catholic Encyclopedia writes that this "expresses the firm hope of the authors of these Inscriptions that their friends have been admitted to Heaven."

(*Catholic Encyclopedia*, anchor, symbol of hope in a future existence)

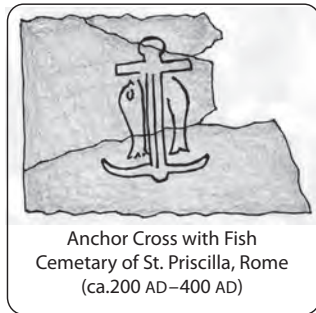

Anchor Cross with Fish  
Cemetery of St. Priscilla, Rome  
(ca. 200 AD – 400 AD)

In this anchor cross form the cemetery of St. Priscilla, the fish represent Christ and the anchor represents the Cross.

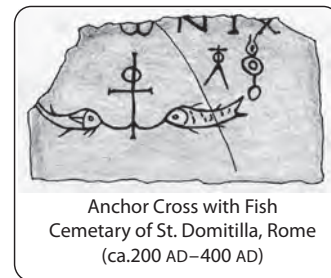

Anchor Cross with Fish  
Cemetery of St. Domitilla, Rome  
(ca. 200 AD – 400 AD)

In this "disguised cross" from the cemetery of St. Domitilla, the fish appear hooked by the arms of the cross.

(*The Original Catholic Encyclopedia*, anchor)

Strangely, from about 300 AD to the Late Middle Ages and the Renaissance the anchor cross fell from use. Charles A. Kennedy, in *Early Christians and the Anchor*, offers an explanation. Early Christians were not afraid to use a little word play. In Matthew 16:18, for example, there is a play on the name Peter and the word *petra* (rock.) The Greek word for anchor, *ankura*, sounds like the expression *en Kurio* which means "in the Lord." Around 300 AD, the epitaphs started to be written in Latin instead of in Greek.

Even though the Latin word for anchor "anchora" matches the Greek word "ankura," the phrase *en Kurio* (in the Lord), in Latin, is "in domina." (Thus the word play didn't work anymore).

(Kennedy, Charles A. *Early Christians and the Anchor*, *Biblical Archaeologist*, Vol. 38, No. 3-4, Dec 1975, p. 115-124)

### *Constantine and the Chi-Rho*

Something momentous happened in the Roman empire around 300 AD. The Roman Emperor Constantine converted to Christianity. The best source of information on this event is Eusebius' (ca. 263-ca. 339 AD) *Life of Constantine* which was appended to his comprehensive *Historia Ecclesiastica* or *Church History*. (Naturally, Dee had this book in his library.) (Roberts and Watson no. 778).

After Emperor Maximilian died, his son Maxentius ruled southern Italy and Constantine ruled Rome. In 312 AD, the two rivals amassed great armies and were about to do battle at Milvian Bridge, six miles northeast of Rome.

Eusebius writes, "Deeming that possession of arms and numerous soldiers was of secondary importance, [Constantine] sought Divine assistance... While engaged in this inquiry, it occurred to Constantine that previous Roman Emperors, who worshipped a multitude of gods and listened to the advice of oracles, never fared very well. Suddenly, he and his army witnessed a miracle. They saw "a cross of light in the heavens, above the sun, bearing the inscription CONQUER BY THIS."

Constantine "doubted within himself" the import of this apparition," but that evening, "in his sleep the Christ of God appeared to him with the same sign he had seen in the heavens, and commanded him to make a likeness of that sign ... and use it as a safeguard in all engagements with his enemies."

Eusebius, who claims that he has seen a representation of the sign personally, describes it: "A long spear, overlaid with gold, formed the figure of a cross by means of transverse bar laid over it. On the top of the whole was a wreath of gold and precious stones, and within this the symbol of the Savior's name, two letters indicating the name of Christ by means of his initial characters, the letter RHO (P) being intersected by the letter CHI (X) in its center." (Eusebius, *Life of Constantine*, 1.31)

The Chi and the Rho are the first two letters in the Greek word ΧΡΙΣΤΟΣ (XRISTOS or CHRISTOS.) This Chi-Rho symbol is often called a "chrismon" from the Latin phrase *Christi Monogramma* (monogram of Christ.)

Constantine had his craftsmen mount this symbol of Christ on top of a long spear that had a transverse bar, making another cross shape. From the crossbar hung a square cloth embroidered with "brilliant precious stones" and gold. Above the crossbar was a waist-up portrait of the Emperor and his children. Constantine insisted that all his armies be led by this "labarum" or "standard on the tall staff."



Constantine's Sign

There's some evidence that the story of Constantine's vision of the Chi-Rho is slightly embellished. In 269 AD, 43 years before the battle at Milvian Bridge, Christians had used the Chi-Rho to symbolize Christ. Also, non-Christians used this exact same symbol as an abbreviation for Greek words like *CHRONOS* (TIME) AND *CHRUSOS* (GOLD).

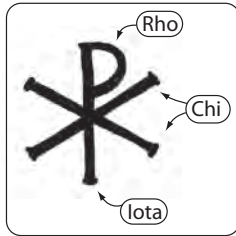

Other research shows that the Chi-rho is actually **three** Greek letters, the "X and P" from ΧΡΙΣΤΟΣ (Xristos or Christ) and also the "I" from ΙΗΣΟΥΣ (IESOUS or Jesus.) (The letter I, or iota, is not apparent because it's also the vertical line of the P or rho.)

An even earlier symbol for Jesus was a six-pointed asterisk, just the Greek letters I and X

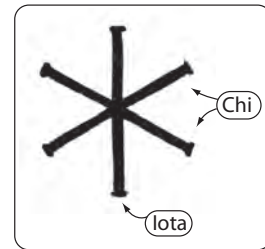

From 300-500 AD, Constantine's Chi-Rho symbol became widespread. It was used on the inside and outside of churches, on coins, cups, rings, furniture, and even eating utensils. In the Middle Ages it appeared on papal documents and official charters. Medieval scribes would decorate it ornately "with flourishes."

In the Late Middle Ages (1300-1450), the Chi-Rho was gradually replaced by the contraction HIS, taken from the three letters in the original Greek word for Jesus, ΙΗ(ΣΟΥ)Σ or ΙΗ(SOU)S. Over time, this origin of HIS was forgotten and Latin scholars explained that it stood for "In Hoc Signo (vinces)" meaning "in this sign (thou shalt conquer). Others explained it as standing for "Jesus Hominum Salvator" or "Jesus, Savior of Men." (OED, HIS, p. 1, 34)

### *The Anchor Symbol in the Renaissance*

In early Christian art, the fish most often portrayed to represent Jesus is the dolphin. While technically it's a mammal, early sailors admired the way the dolphins would joyously swim and leap alongside their ships. Perhaps they saw them as guides, like Jesus would guide them safely to their destination, and eventually to heaven.

From about 1350 to 1830, the heir-apparent or prince to the French throne was called "le Dauphin," and the dolphin appeared on the royal coat of arms.



The renowned Venetian humanist and printer Aldus Manutius (1450-1515) used a dolphin wrapped around an anchor as a printer's device, or mark for his Aldine Press.



Coat of Arms for the French Dauphine

## Dee's "Anchor of Hope"

With this historical background, it's easier to see and understand the many clues in the Title page of *General and Rare Memorials* that express the "Hope is an anchor of the soul" theme from Hebrews 6:19.

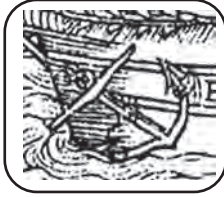

The most obvious clue is the anchor attached to Elizabeth's boat. Graphically, there is nothing really unusual about it, except that it perhaps seems slightly large for the scale of the boat.

But it relates to the two symbols on the tops of the masts of the same ship. These two symbols are not simply "Chi-Rho," representing the name of Jesus, but they are **Anchor Chi-Rho symbols**. Those crescent shapes do not represent the Moon, they represent the arms of an anchor.



Dee didn't invent this symbol by any means. The Anchor and Chi-Rho combination had been used since the early days of Christianity, but it was much less frequently used as simply the Chi-Rho by itself or the Anchor by itself.

It's curious that there are two identical symbols here. The one on the taller mast is almost touching several of the radiating lines bursting from the representation of YHWH in the upper-right-hand corner. The oversized boat anchor and the two "Chi-rho Anchors" all seem to be expressing "HOPE."

He also emphasizes the word HOPE twice on page 64 at the his conclusion of his book. After explaining that, "No Kingdom" has the: "TIMBER, SHIP-WRIGHTS, willing and ABLE subjects, HARBORS, and INVINCIBLE strength of England, he writes:

**"Our hope, then is to**  
**1. preserve Amity and Peace ... with all Foreign Princes;**  
**And to Guard this State-Public in 2. Security...**  
**And to 3. keep our own hands and hearts from Doing or Intending**  
**Injury, to any Foreigner, on Sea or Land."**

Dee continues:

**"Our hope is, (said he) that upon this Godly 1. Intent,**  
**Discrete 2. Covenant,**  
**and Public Contributory 3. Oblation:**  
**the Omnipotent 4. Author of Heavenly Peace, will so bend down**  
**his Merciful and gracious Eyes upon us ..."**

Besides throwing in a reference to 3 things and 4 things (perhaps a cryptic reference to Quaternary rests in the Ternary), Dee uses the word “Hope” in three important summarizing sentences. Thus we might expect to see this word emblazoned on the Title page illustration.

But besides the suggestion of it in the oversized anchor and the two chi-rho anchors, the word Hope is nowhere to be seen. But remember, it’s Dee’s style to put things right in front of your faces, yet still it’s invisible, unless you look at things a little more creatively.

### *Can you find where Dee hid the word HOPE?*

Dee loved letters. And he loved to play word-games with letters. He signed his name with an equilateral triangle, the Greek delta, the “Dee,” the “fourth letter” in the Hebrew, Greek, and Latin alphabets. The *Monas Hieroglyphica* is full of “letter-clues.” Let’s closely examine the letters the Greek and Latin letters of this IEROGLYPHIKON BRYTANIKON illustration to see if we “Dee-code” it.

There are 12 letters in Dee’s Greek word “IEPOGLYΦIKON” and 10 letters in “BRYTANIKON,” making a total of 22 letters.



Dee’s preliminary drawing for the Title page of *General and Rare Memorials*

In his preparatory sketch for the Title page Dee distributed the letters in groups of 4, 8, 3, and 7 (starting from the top, going clock-wise IERO GLYΦIKIN BRY TANIKON).

These are key numbers in the *Monas*. In Theorem 6, Dee calls the Cross, “Ternary,” “Quaternary,” “Septenary” and “Octonary.” These four numbers also appear in his unusual division of the additive result of his Artificial Quaternary of Theorem 23, where he divides 8 into (1 + 7), then 7 into (3 + 4).

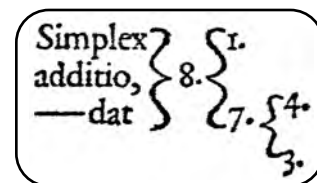

But in the final printed version of the Title page of *General and Rare Memorials*, he distributes the 22 letters differently. There are 5 letters on the top, 5 letters on the bottom, and 6 letters on each side.

It seems as though Dee sacrificed a “number clue” (perhaps he felt it was too obvious, or maybe even too obscure) in favor of a more symmetrical distribution of the 22 letters. But there seems to be another reason.



The easiest letters to read are those along the top, the rest are either sideways or upside down. In Dee's preliminary sketch he had the 4 Greek letters I, E, P, and O along the top margin. The Latin version of the Greek word "IEPOGLYΦIKON" is "HIEROGLYPHICA," (a word very near and dear to Dee).

If we were to add that silent H to the prominent letters along the top, we would have all the letters to spell HOPE.

Well, sort of. If the word was "Latinized" to get the H, the Greek P (actually a "rho") would become a Latin letter R, and we would not be able to create the word "HOPE." For his final, printed version, it seems as though he opted to make the "HOPE clue" more graphic. He moved the Greek Γ (gamma) from the right margin to the top margin (now making 5 letters on top).

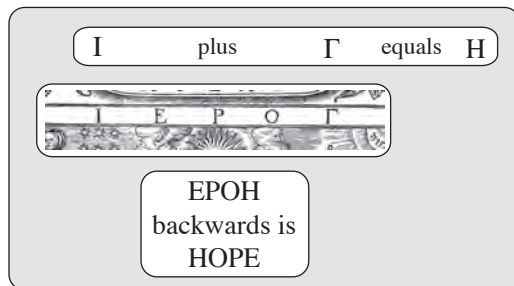

If the letter I (Iota) is brought over to join with the Γ (Gamma), and the horizontal arm of the Γ (Gamma) is lowered a bit, it's not hard to see them graphically making an H (the Greek letter "Eta").

Even though these four letters "E, P, O, and H" are still Greek letters, it's hard not to see them as spelling the English word "HOPE," backwards.

These letters H, O, P, E are prominent because they are, not only front and center, they are the only "right-reading" (not sideways or upside down) letters of all the margin letters. In addition, they are also in close proximity to the two "Anchor Chi-Rhos" at the top of Elizabeth's galleon.

But Dee doesn't stop there.

Right next to the anchor, "stedfastly" fastened to the hull of the galleon, is the Greek word EYPΩΠH or EUROPH.

It's very strange that Dee should spell the name of this well-known Greek goddess EUROPH instead of the more standard spelling EUROPA.

It's not an engraver's error as he also clearly spells it EYPΩΠH (or EUROPH) in his preliminary sketch. But he apparently had the engraver obscure the bottom half of the last two letters to make his strange spelling less noticeable. His reason is obvious. He made the final letter an H so all the letters in the word HOPE could be found: EUROPH.

EUROPE  
sounds like  
YOUR-HOPE

With regards to pronunciation, the word "Europe" even sounds like "Your-Hope."

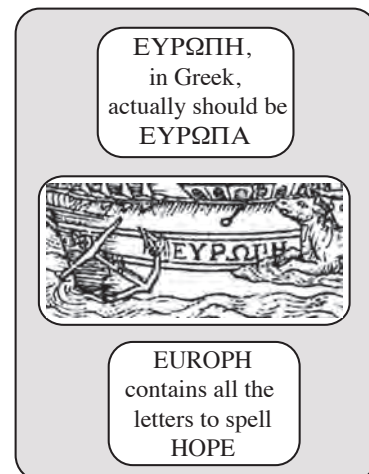

This is quite clever, but he did it to alert the reader to **even cleverer** ways he hid the word HOPE.

The Greek word for HOPE is ΕΛΠΩ or ELPO. Three of these letters (Ε, Π, Ω) can be found in ΕΥΡΩΠΗ, but alas, there is no Λ (lambda). A lambda is essentially two lines that come to a point, like an upside down V. Recall that Dee used this letter trick in the “Secret Vessels of the Holy Art” diagram in Theorem 22 of the *Monas* (part of the letter-puzzle that spelled LVX, and eventually the Roman numeral 2520).

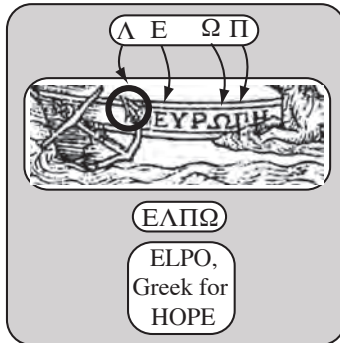

Just to the left of the word ΕΥΡΩΠΗ, the fluke of the anchor has been engraved to look like a Λ (lamda). To reinforce his intent, Dee hid the other fluke under water (something that a navigational expert like Dee would even advise against, as it would affect steering).

Thus, Dee has cleverly concealed the word HOPE and ΕΛΠΩ (ELPO) on the hull of Elizabeth’s galleon right next to the prominent ANCHOR (of HOPE)!

But that’s not all.

Flowing around the hill-fort or citadel is the flowing ribbon “TO THS ασφαειας φρουριουμ” or “TO TES asph-eleias phrouriom” or “watch-out for danger.”

Strangely, the first two words are written in capitol letters and the last two words are written in lower case letters.

Dee seems to have had this subtle change so that the “H” in “THS” would be prominent. The lower case Greek letter “eta” (η) looks more like a Latin letter “n” than an “h” or “H”. (Another clue is that the “S” in THS should be a Greek Sigma Σ, but it’s a capital “S” instead.)

So, again, the 4 letters of the word HOPE can be found. (And again, the Greek letter P [Rho] is to be “seen” as the Latin and English letter “P.”)



But wait, there’s still more.



I’m sure it did not escape Dee that the word HOPE can also be spelled from the first two letters in HONI and PENSE in the adage “HONI SOIT QUI MAL Y PENSE.”

If the Greek words  
 IEPOGLYΦIKON BPYTANIKON,  
 are Latinized to HIEROGLYPHIKON BRITANIKON,  
 HOPE can be found in HiErOglyPhikon.

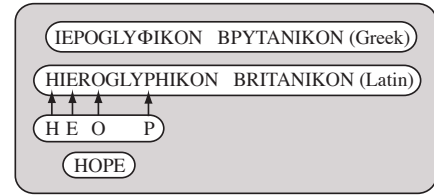

And finally, having found all these HOPE's and the Greek word "ELPO" makes it easier to see the most in- your-face representation of all. Let's return to those prominent Greek letters IEPOΓ from the word IEPOGLYΦIKON.

This clue involves thinking in Greek and Latin (or English) at the same time. Imagine the Greek P (Rho) as a Latin P. Imagine the Greek Γ (Gamma) reoriented to become a Latin L. (Dee demonstrates this with the two L's that make an X in Theorem 16 of the *Monas*.)

Now we have all the Latin letters to spell ELPO, which is the pronunciation of ΕΛΠΟ, the Greek word for HOPE.

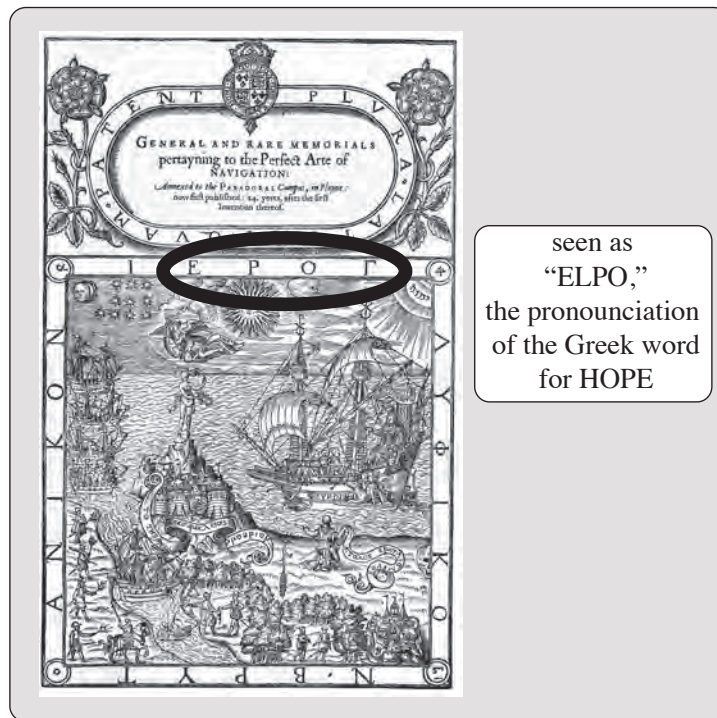
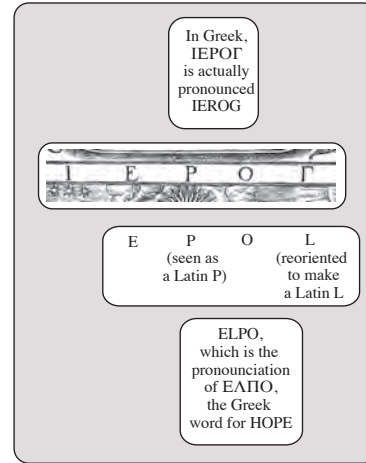



seen as  
 "ELPO,"  
 the pronunciation  
 of the Greek word  
 for HOPE

To summarize,  
the idea of seeing the word HOPE  
in Dee's busy Title-page  
at first seemed hopeless.

But by studying it closely, with Dee's clever letter-and-word-play in mind,  
there are heaps of HOPEs,  
right in front of your very eyes.

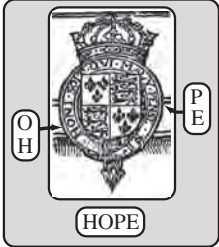
ΙΕΡΟΓΛΥΦΙΚΟΝ ΒΡΥΤΑΝΙΚΟΝ (Greek)  
HIEROGLYPHICUM BRITANICUM (Latin)  
H E O P  
HOPE







Anchor of Hope  
Chi Rho crosses



Anchor  
of Hope



ΤΟ ΤΗΣ ασφαλείας φρουριου  
O H E P  
HOPE



ΕΥΡΩΠΗ,  
in Greek,  
actually should be  
ΕΥΡΩΠΑ



EUROPH  
contains all the  
letters to spell  
HOPE

I plus Γ equals H



ΕΡΩΗ  
backwards is  
HOPE

In Greek,  
ΙΕΡΟΓ  
is actually  
pronounced  
ΙΕΡΟΓ



E P O L  
(seen as  
a Latin P) (reoriented  
to make  
a Latin L)

ELPO,  
which is the  
pronunciation  
of ΕΑΠΟ,  
the Greek  
word for HOPE

Α Ε Ω Π



ΕΑΠΩ  
ELPO,  
Greek for  
HOPE

EUROPE  
sounds like  
YOUR-HOPE

Three Quotes from Dee's text that emphasize "Hope":

"Why should not we HOPE that RES-PUBL. BRYTANICA [The British State] on her knees...( p. 53)

"Our hope is, (said he) that upon this Godly 1. Intent,Discrete 2. Covenant... (p.64)

"Our hope, then is to 1. preserve Amity and Peace ... with all Foreign Princes... (p. 64)

Here's a visual summary of the meaning of the words on the flowing ribbons on the Title page.



TO TES ασφαλειας φρουριου

|   |  |   |
|---|--|---|
| TO TES<br>To tes<br>In order to,<br>so that | ασφαλειας<br>aspheleias<br>steadfast,<br>firm,<br>immoveable,<br>sure,<br>certain,<br>secure | φρουριου<br>phrouriom<br>watch-post,<br>garrisoned fort,<br>citadel |
|---|--|---|

In order to make a steadfast watch-post



Στολος εξωπλισμενος

|  |  |
|--|--|
| Στολος<br>Stolos<br>an expedition,<br>a journey,<br>a voyage,<br>a mission | εξωπλισμενος<br>exoplismenos<br>exormau ploos<br>too send sailing<br>forth |
|--|--|

Send forth a sailing expedition

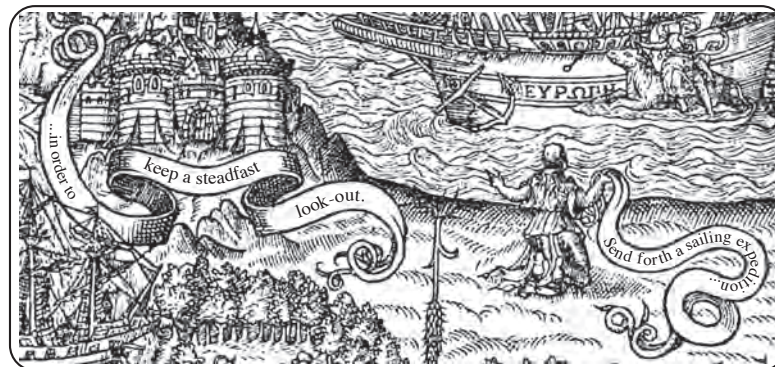

My translation of Dee's Greek words.

### *To watch and to be at anchor in a place of refuge*

In the flowing ribbon embracing the citadel, Dee uses the word “phrouriom.” In his description of the “Hieroglyphic Britanikon” **in his text**, Dee uses the expression ΦΡΟΥΡΙΟΝ ΤΗΣ ΑΣΦΑΛΕΙΑΣ or (to PROURION TES ASPHALIAS). ASPHALIAS means steadfast, firm, sure, certain and PROURION (a form of the verb PROUREO) means to keep watch or to guard. So he is saying “Send forth an expedition” to “keep a steadfast watch.”

A related word PHROURION, means a watch-post, garrisoned fort, or citadel, which is exactly what he has drawn at the foothills at Lady Occasion's mountain.

Also related are the words PROURUS (watch-tower), PROURIS (a guard-ship), and PROUROS (a guard). (Liddell/Scott, p. 873)

### *PHROURIONM – to watch, to guard*

However, in the flowing ribbon surrounding the watch-tower/citadel below Lady Occasion, Dee handles PHRORION differently than in the text. Not only is it lower case, but the N has been replaced with an M, making it phroriom. This “iom” ending is not a common Greek word-ending, if it’s proper at all. Why did Dee change the “N” to “M”?

### *EPHORMEO – to be at anchor, to blockade*

Based on a visual clue in the illustration, it seems that Dee wanted us to see a similar word *ephormeo* which means to be “**at anchor, moored, or to blockade (a place).**” Thucydides and Herotidus use this word frequently when describing the famous naval battles in Greek history. (Liddell/Scott, p. 340)

The single galleon in the river is clearly anchored there. Its anchor is not attached to its hull, and one can even see the anchor rope descending into the water. The water’s current curls around the hull. If the tide was going either in or out, realistically the boat should be either pointed towards the reader or away. But instead the boat is seen broadside. Not only do parts of the bow and stern extend over the shorelines, but the mast extends over the flowing ribbon, forcing the words “TO THS” to the left.

In short, the “anchored” boat is visually “blockading” the river, a perfect depiction of *ephormeo* (to be at anchor or to blockade.)

Not only that but the 4 other galleons are all anchored, making a grand blockade of only of the mouth of the river, but also the whole sea up to the horizon. They are “ephormeo” as well.

### *EPHORMIZO – to seek refuge*

A related word “ephormizo” (-izo means “to bring”) means to “**bring a ship to its moorings,**” “**to come to anchor,**” or to “**seek a place of refuge**”.

Now, here’s the punch line, what would an Italian sailor call a place of refuge? Refugio! This is what Giovanni Verrazzano called Narrangansett Bay in the year 1524.

And in 1583, John Dee renamed it the Dee River, as the deed for the Gilbert/Peckham/Dee expedition reads:

**“all that river or porte called, by Master John Dee, Dee Ryver  
which Ryver by the discripcon of John Verarzanus, a Florentyne,  
lyeth in Septontrionall latitude about fortye twoo degrees  
and has his mouth lying open to the south halfe a league broade  
... conteyneth in it selfe five small Islandes newlie named the Cinque Isles.”**

(Septontrionall simply means Northerly, as in  
“about 42 degrees” latitude, north of the equator.)

This deed doesn't mention the word Refugio, but Dee cites Verrazzano himself and that's what Verrazzano called it in the report of his journey.

The Cinque Isles (or 5 islands) are not shown in Dee's Title-page illustration, but they might be represented by the 5 nearly-identical galleons involved in this "blockade." (Putting all 5 galleons in the river would look too peculiar, so he put them in the sea to also make use of them in his "4 pyrologians and 4 galleons = octave" mathematical game.) The fact that these 5 ships are "at anchor" is yet another subtle reference to the word "HOPE."

Even though *General and Rare Memorials* was published in 1577 and Gilbert's expedition destined for Refugio didn't depart until 1583, Dee was probably aware of this bay as early as the 1550's, from discussions with his cartographic buddy Gerard Mercator.

If Dee was so vociferously urging an expedition, you can be assured he had a specific destination in mind.

### ***The "Anchor of Hope" in the Greek words of the Title page***

If all these graphic representations of the idea of the "Anchor of Hope" aren't enough, there is even more evidence of it in the Greek words on the flowing ribbons. There are some subtle differences between the way Dee writes these Greek words on page 53 of the text, versus how he writes them on the Title page.

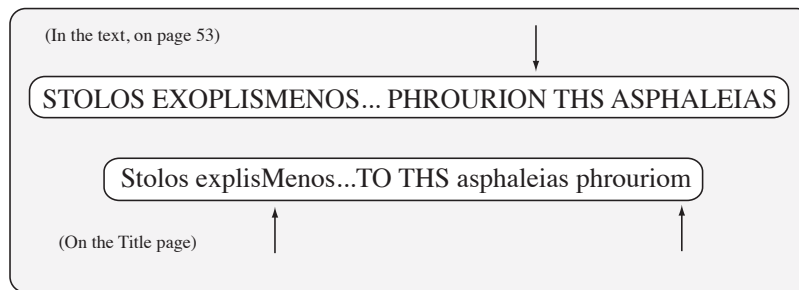

In the text, STOLOS EXOPLISMENOS is capitalized. On the Title page it's in lower case letters, except for the S, and the M. Capitalizing the S is understandable as it starts the expression, but the large M is unusual.

The two main words of the second expression have been reversed, and have likewise been engraved in lowercase letters, except for the TO THS. (We've already seen that the capitol H is useful in seeing the word HOPE in the expression.)

But the other unusual thing is that Dee changed the last letter of PHROURION, making it phrouriom.

By changing the word order, changing "N" to "m" and adding the word "TO" the title-page expression seems to be saying: "to make a steadfast watch-tower."

This is exactly what the Queen did! She "sent forth an expedition" (the Gilbert/Peckham/Dee project) to make a steadfast watch-tower (the John Dee Tower). Steadfast it is indeed (as it still stands today) and watch-tower it is as well, not only because it has windows, but because the great location of Narragansett Bay on the East Coast provides a strong base useful for monitoring maritime activities along the North Atlantic coast.

## Refugio

What I'm suggesting is that the waterway illustrated here is Verrazzano's Refugio – the John Dee River – Narragansett Bay, and the settlement depicted is the John Dee port – Newport, R.I.

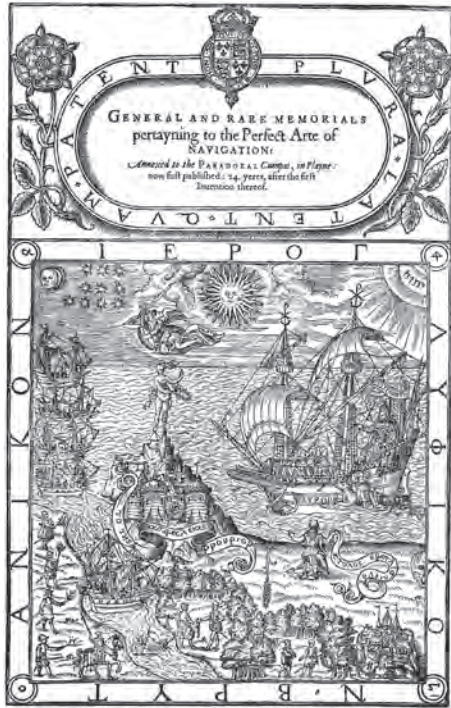

Admittedly the citadel on the hill doesn't look like the John Dee tower. Even though it has two prominent circular towers, they are crenellated with medieval style battlements.

Along with the prominent windows, this whole structure is simple meant to say strong, fortified, fortress. If Dee illustrated the John Dee Tower on this hill, the whole scene would be too obvious. Instead he hinted at the tower in 2 other ways.

The first is the tetrahedron that is even higher up the mountain than the citadel. The tetrahedron (nature's most basic 3-D shape) represents the harmonious geometry of the Tower and how they both relate to the incredible cuboctahedron.

The second way is the almost cinematic way Dee leads the eye from the citadel, to the flowing ribbon, to the ship anchored in the river, to the pyrologians, the towboat, the trading men, the walking men, the town, and finally to the John Dee Tower at its apex.

The representation of the John Dee Tower in the town, the tetrahedron, and the citadel on the hill are all the same thing, even though Dee has scattered them about.

I'll admit this sounds speculative, so let's dig a little deeper for more proof (in Dee's words and images and even numbers)



## *Analysis of the “Anchor of Hope” quotation in Hebrews 6:18-19*

To take a even closer look at the “Anchor of Hope” quote from Hebrew 6:18-19, let’s break this quote down into four sections, A, B, C, and D.

The “Anchor of Hope” quotation  
from Hebrews 6: 18-19

|   |  |
|---|--|
| A | We ... who have fled for refuge        |
| B | to take hold of the hope set before us |
| C | which we have as an anchor             |
| D | to the soul, steadfast and sure ...    |

|     | ENGLISH<br>(my translation)                   | GREEK<br>(per Stuart and Hart)         | LATIN<br>(per St. Jerome)                |
|-----|---|--|--|
| (A) | We who have<br>fled for refuge                | echômen hoi<br>kataphugontes           | habeamus qui<br>confugimus               |
| (B) | to take hold of the<br>hope<br>set before us  | kratêsai tês<br>elpidos<br>prokeimenês | ad tenendam<br>spem<br>propositam        |
| (C) | which we have as an<br>anchor<br>to the soul, | hên echomen<br>ankuran<br>tês psusches | quam sicut<br>anchoram<br>habemus animae |
| (D) | steadfast<br>and<br>sure                      | asphalê<br>te kai<br>bebaian           | totam<br>ac<br>firmam                    |

Here’s how it was originally written in Greek, and how St. Jerome translated it into Latin around 400 AD.

“Anchor of Hope” quotation from Hebrews 6:18-19

This 3 language chart is rather busy, so let’s investigate the key words one section at a time

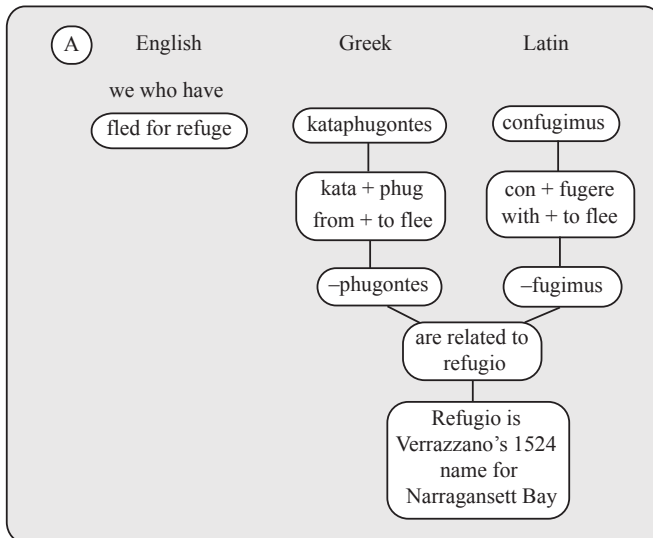

A. The original Greek New Testament uses the word *kataphugantes*. The prefix “kata” means “from,” and the root word “phug” means to flee.

In the Latin word *confugimus*, the prefix “con” means “with,” and the root word “fugere” (which derives from the Greek “phug”) means to flee.

The English word *refuge*, the Greek ending *-phugontes*, and the Latin *-fugere* are all related to Verrazzano’s Italian 1524 name for Narragansett Bay: *Refugio*.

The citadel on the shore in Dee’s illustration is embraced by the “to make a steadfast watch-tower” flowing ribbon.

The word “phrouriom” (watch-tower) is related to the word “ephormizo” which means “to seek a place of refuge,” another expression of “Refugio.”

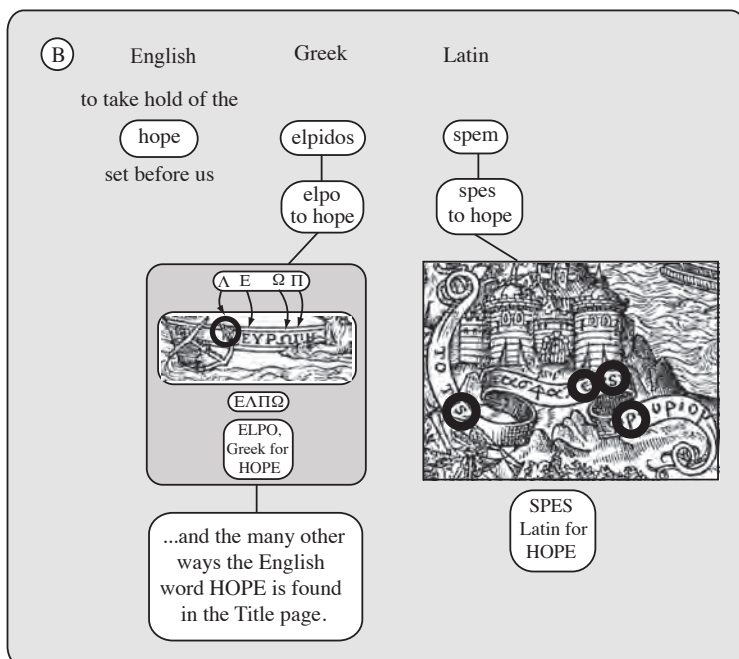
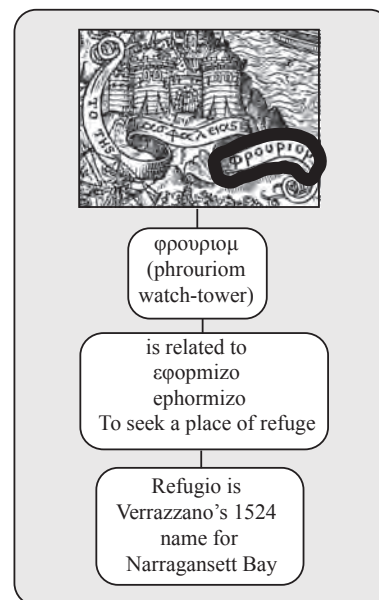

B. The original Greek word for the word “hope” is *elpidos*, a form of “elpo.” In the Latin, the word is *spem*, a form of “spes.”

We’ve seen the many ways “hope” is disguised on the title-page. We’ve also seen how the ELPO can be found using the lambda-shaped fluke of the anchor and the letters found in the name of the goddess and continent Europa.

If Dee’s Greek expression “TO TES ασφαλειας φρουριον” is seen with “Latin letter eyes,” the word *spes* (hope) can be found.

C. The word anchor hasn't changed much over the millennia, from the Greek ankuron to the Latin anchoram to the English anchor.

Besides the prominent anchor on Elizabeth's galleon and the Anchor Chi-Rhos atop the masts, it is also hinted at in the flowing ribbon that wraps the citadel. The word phouriom is very similar to the "ephormeo" which means "to lie moored at" or "to blockade."

The difference between this word "ephormeo" and the word "ephormizo" (seen in A) is that the suffix "izo" means "to bring." Thus instead of inactively "being at anchor", ephormizo means the action of bringing a ship to anchor in the process of seeking refuge.

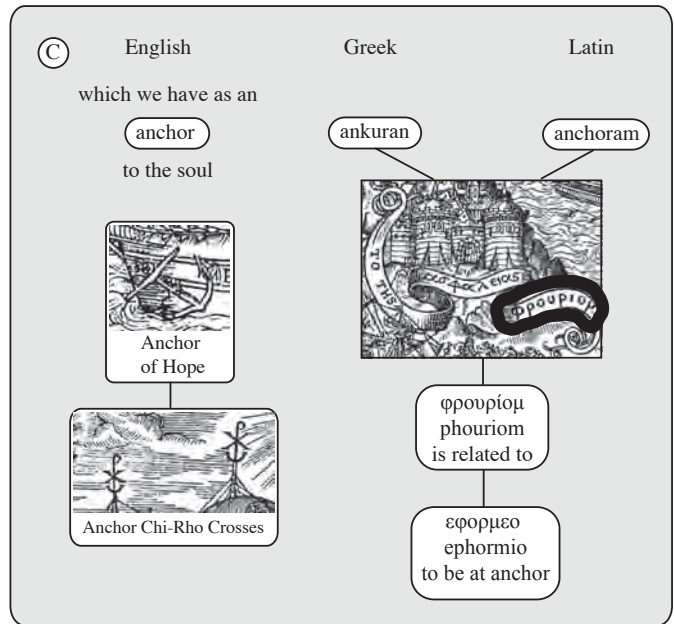

D. Here's a real confirmation that we're on the right track! The word used in the original Greek Bible for steadfast was "asphalê." This is a form of the very same word that Dee chose to use in his flowing ribbon: "asphaleias."

Furthermore, the letters of the Latin word used by St. Jerome, "tutam," can all be found in the Latinized spelling of "TO TES ασφαλειας φρουριουμ." This appears to be one reason why Dee changed the n at the end of "phrorion" in the text version, to "phroriom" on the Title page. While we're on the subject, there is another reason Dee changed the n to m. In the other flowing ribbon, recall that he capitalized the letter m in the otherwise non-capitalized phrase.

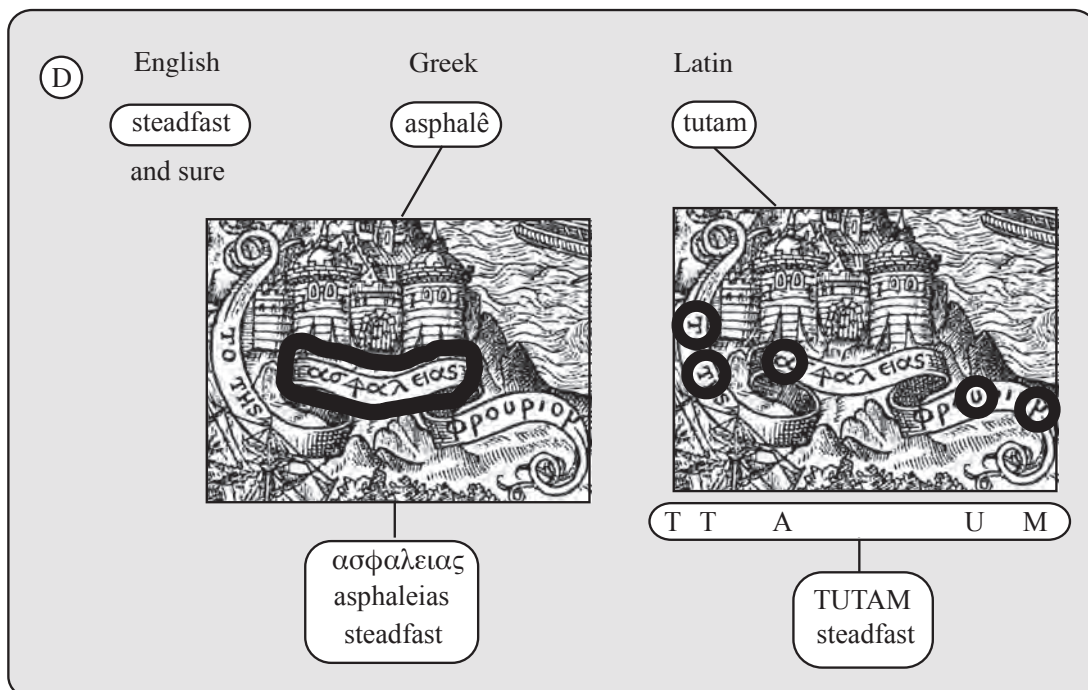

Dee seems to be calling attention to two letter M's here. This is a big theme in the *Monas Hieroglyphica* where the M, the 12th and middle letter of the Latin alphabet, signifies the number 12. Two M's make 24. Thus these two errant m's are a cryptic reference to Dees "secret proportions" in the *Monas*. (See Theorem 11 regarding the 24 hours on the equinox and the two arms of the cross each labeled M in the Secret Vessels of the Holy Art diagram in Theorem 22.)

Incidentally the Greek root word for *asphalês* (steadfast, firm) is *sphello* (to bind tight). The Greek word *sphuxus* (pulse) also derives from *sphello*. Our modern word asphyxiate (suffocation) comes from *a* (without) plus *sphuxus* (pulse). Though the *a* in *asphalês* does not mean "without," *asphalês* and *asphyxiate* are cousins. Though our modern word asphalt comes from the Greek word *asphaltos*, it is of foreign derivation and apparently not related to *asphalês*.

(Liddell/Scott, p. 127)

To summarize, at first sight, the Title page illustration seems to be a strange confusion of graphic elements and foreign words. But not very far beneath this veneer are over a dozen powerful, interrelated clues that use the metaphor of "Anchor of Hope" in the graphics, letters, and words.

And if you think I'm being a bit too creative in my interpretation, remember what Dee himself wrote in that special lozenge shape surrounding the title:

"PLURA LATENT QUAM PATENT,"  
OR  
"MORE IS HIDDEN THAN IS OUT IN THE OPEN."

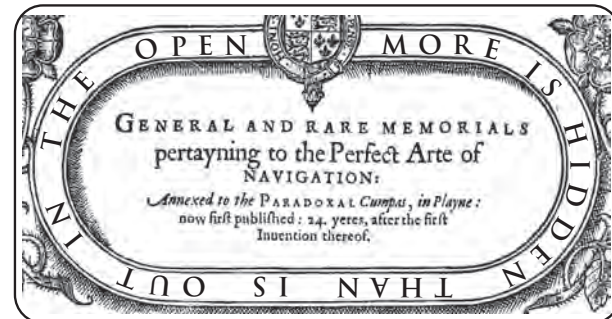
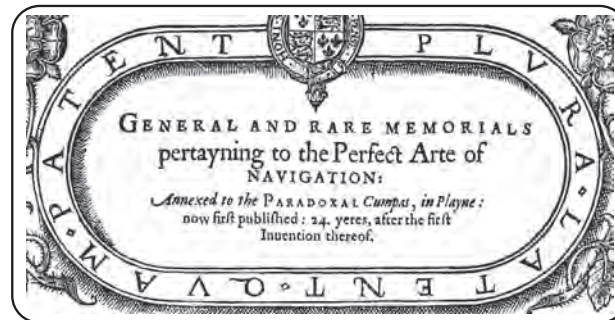

How many books do you know in which the author broadcasts on the Title page that he has hidden clues in the artwork?



# THE 42 STORY

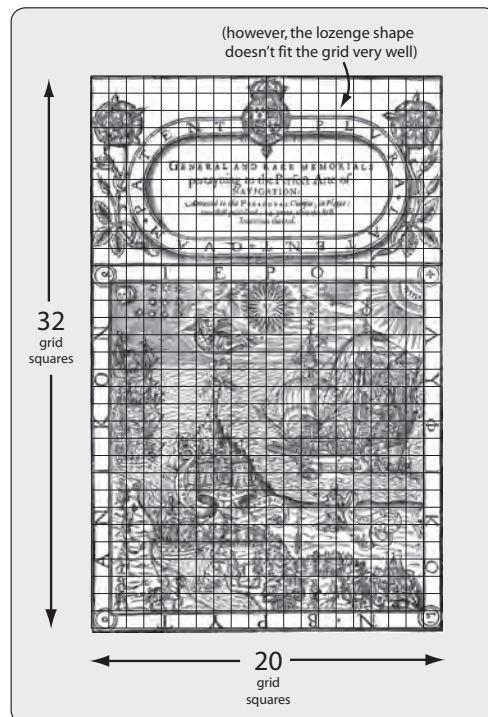

## *The Proportions of the General and Rare Memorials Title page*

Knowing that Dee based the Title page of the *Monas* on a grid, it seemed likely that the *General and Rare Memorials* Title page's grid was important as well. Unlike the *Monas*, which has an overall "height: width" proportion of 4:3, this one was 8:5.

Using the width of the border of the illustration (that contains the words IEROGLYPH- IKON BRYTANIKON) as a guide, I found that a 32 X 20 grid fit perfectly. This made a total of 640 grid squares.

The lozenge shape was 8 grid squares tall by 16 grid squares wide. The width fit the grid perfectly, but the height seemed to be out-of-register by about a half of a grid.

So I made a finer grid that was 64 X 40, and that issue was resolved. This made a new total of 2560 squares. This is only 40 squares more than 2520, a number very special to Dee.

If he had simply eliminated one horizontal row, the grid would be 63 units tall by 40 units wide = 2520 units. “Dee must have something else up his sleeve,” I thought.

So I measured how many grid square there were in just the illustration (including the letters on its perimeter.) (You can see that it’s slightly taller than it is wide). The height was 42 grid squares and the width was 40 grid squares (making 1680 in total.)

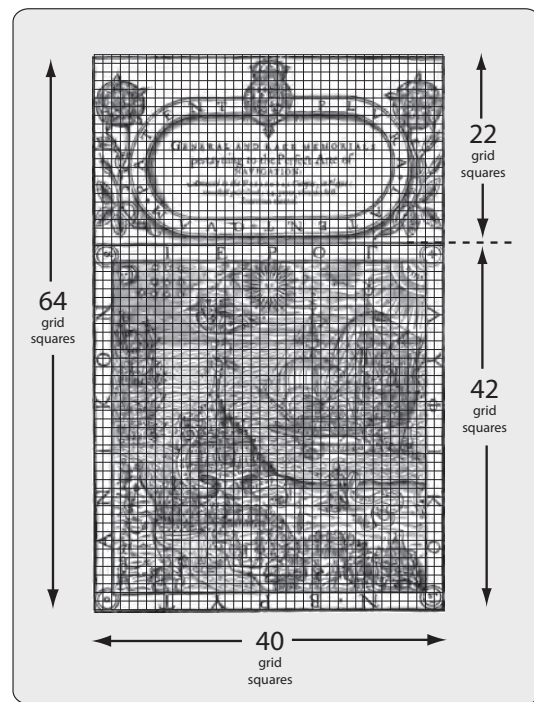

I had been surprised to find archangel Michael to be number 42 on the list of the 72 names of the angels. Now another reference to 42. Suddenly it struck me, Dee is cryptically expressing the latitude of the John Dee River and port!

**“all that river or porte called, by Master John Dee, Dee Ryver  
which Ryver by the discripcon of John Verarzanus, a Florentyne,  
lyeth in Septontrionall latitude about fortye two degrees...”**

Verrazano says the latitude is “42 2/3 degrees,” and in actuality, it is closer to “41 1/2 degrees.” Dee might have made his 42 degree estimate based on maps or perhaps data obtained during Simeo Fernandez’ renaissance mission. However he got his information isn’t really important, because Dee covers himself by saying “**about**” 42 degrees.

It’s the number 42 that Dee liked. And Dee’s reasoning goes much further than 42 simply being the reflective mate of 24, or 42 being archangel Michael’s uniform number.

### ***The 42 Names of God***

In the Cabbalistic tradition, besides the 4 letter name of God YHWH, and the 72 letter name of God or the 72 angels (the Schemhamphorasch) there is also a 42 letter name of God. Proof that Dee was familiar with this 42 letter name can be found in Dee’s handwritten transcription of his “conversations with the angels.”

In March of 1582 Dee’s hired crystal ball reader Edward Kelley was able to “make contact” with the archangel Michael. Through Kelley’s voice, Michael told Dee to make a seal from undyed beeswax and inscribe it with certain geometric shapes and letters signifying various names of angels. (Harkness, p. 35-36) This “Seal of God” (Sigillum Dei) was to be used as a support for the crystal showstone.

Its 7-pointed-star shape is almost identical to the Sigillum Dei found in *Liber Juratus* (The Book of the Oath, but often called the Sworne Book of Honorius) written around 1220 AD. Dee had a copy of this influential Medieval magic text in his library at Mortlake. (In the 1600's the German Jesuit scholar made his own version.)

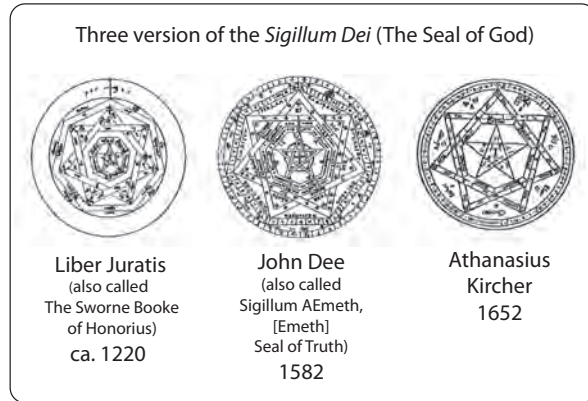

Dee knew there had been several other variations of the seal, so he asked Michael, through Kelley, to “provide a definite version for his works.” Michael instructed them to divide the outer circle into 40 equal parts. Dee did so by quartering the circle, then dividing each quadrant into 10 parts.

Kelley then had a vision appear to him of “40 white creatures, all in white silk long robes and they like children.” (Peterson, p. 92)

Later, the 40 creatures “stood together 5 together and 5 together so in eight companies each of 5.” (Peterson, p. 98)

After receiving more explanation about the numbers and letters of these white silk robed creatures, Dee finally questioned Michael:

**“Δ: I have read in Cabbala of the Name of God of 42 letters:  
 but not yet of any, of 40 letters.  
 That of 42 letters is this:”**

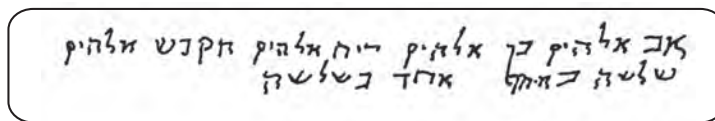

Dee's handwritten 42 Hebrew letters in the Name of God,  
 which he got from his book by Catholic priest Petrus Galatinus

Dee then shows two more 42 letter Hebrew versions that relate to the Christian Kabbalistic tradition.

In the margin, Dee notes that he got these versions from a book he had in his library by the Catholic priest Petrus Galatinus (1460-1540). (Roberts and Watson, book # 216)

The mathematician Uri Raz (from Israel) writes that the “**42 Letters Name of God**” is one of God's many names used in the Zohar and in the writings of Rabbi Moshe Cordoviro and Rabbi Abraham Abulafia.

**“In the Zohar, 72-fold Name of God  
 and the 42 Letters Name of God  
 are often discussed together,  
 and described as a complementary.”**

(Raz, p. 1)



Some scholars think that the 42 Letters Name comes from a prayer written around 150 AD, the “*Ana Bekoah*.” These are the first two words of a prayer attributed to Rabbi Nehunya Ben Hakana. Others believe the name is “the result of permutations of the first 42 letters of Genesis.” (Raz favors the “*Ana Bekoah*” origin.) (Raz, p. 1)

In the 1200’s, Rabbi Moses ben Maimon or Miamonides, referred to the 42 names as *de nomine quadraginta duarum*. (Wirszubski, Pico, p. 93)

This “**40-verses-42**” discrepancy clearly set off a red flag for Dee, but he went along with it and kept the 40-part division on the outer ring of the Sigillum Dei.

Nine months later, on November 16, 1582, Kelley had another vision of a company of living creatures, “some with crowns or garments in their hands.” **Curiously, this time there were 42 of them.**

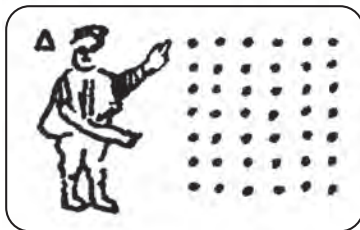

Dee’s (signed) self-portrait next to a grid of 42 dots

Dee made a quick sketch of how they were arranged (6 columns by 7 rows) and even drew a self -portrait (notice the triangle) next to it. (Peterson, p. 204)

Later that night, letters were revealed, and Dee summarized them in his “first dictata penning of my own fantasie.” He divided a circle into six parts and put a 7-letter name in each part.

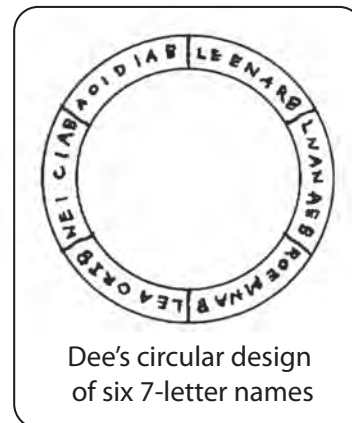

Dee’s circular design of six 7-letter names

Now instead of 40, it’s all about the **42**.

On November 20th, the company of **42** “seemed to stand round about a little hill of Claye.”

Then the **42** hold and toss a round table into fiery flames.

Then **42** people take letters “from their foreheads and set them in a circle.”

(Peterson, p. 240-242)

## *Summary: Refugio and 42*

To summarize, archangel Michael is number 42 (out of 72 angels).

In the Cabbalistic tradition there is also a 42 letter name of God.

The John Dee River and port is located “about 42 degrees” latitude.

The Title page illustration was designed on a grid 42 units tall by 40 units wide.

With all its references to 42, it’s seems like Dee is actually depicting his proposed colony (at what is now called Narragansett Bay) in the Title page illustration.

Cornelius Agrippa writes that four specific angels rule over the “corners of the world.”

(Tyson, in Agrippa, p. 257-8 and Peterson, p. 25)

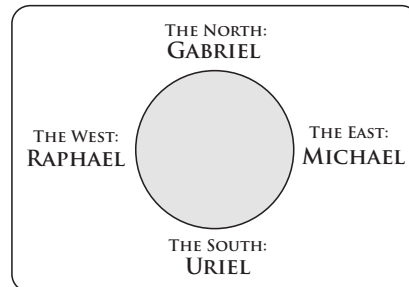

As Michael is the angel of “The East,” this helps provide the compass bearings for Dee’s illustration. Right next to Michael is the sun rising in the East. (As it is on the vertical midline of the illustration, the sun appears to be expressing “the first of Aries,” the Spring equinox, the beginning of a “new year” or “new time.” Dee was pretty enthusiastic about this “first Elizabethan colonizing effort” in the “New World.”

Dee used a little artistic license to keep things somewhat cryptic. The opening of the river’s mouth is not exactly facing south, and the 5 islands are not shown, but these are 5 boats that seem to represent the Cinque Isles.

(Dee apparently borrowed the term “Cinque” from the “Cinque Ports,” 5 English towns on the English Channel, where the crossing to France is the narrowest. These 5 ports banded together for military and trade purposes, and kept the old Norman name.)

Let’s put all these clues together to graphically see what Dee is expressing with his title page illustration.

In Dee's description of Refugio, he says it is at "about **42** degrees" north latitude.

Michael is angel number **42**.

The illustration is **42** grid squares tall.

The 4-letter Name of God is mentioned,  
but Dee definitely knew about the **42** word Name of God.

All this leads me to conclude that the river is the John Dee River,  
and on the nearby land are three depictions of the John Dee Tower:

the tetrahedron,

the "steadfast watch-tower,"

and the small representation of the building rising above the town  
(with its pillars, columns, dome, and finial).

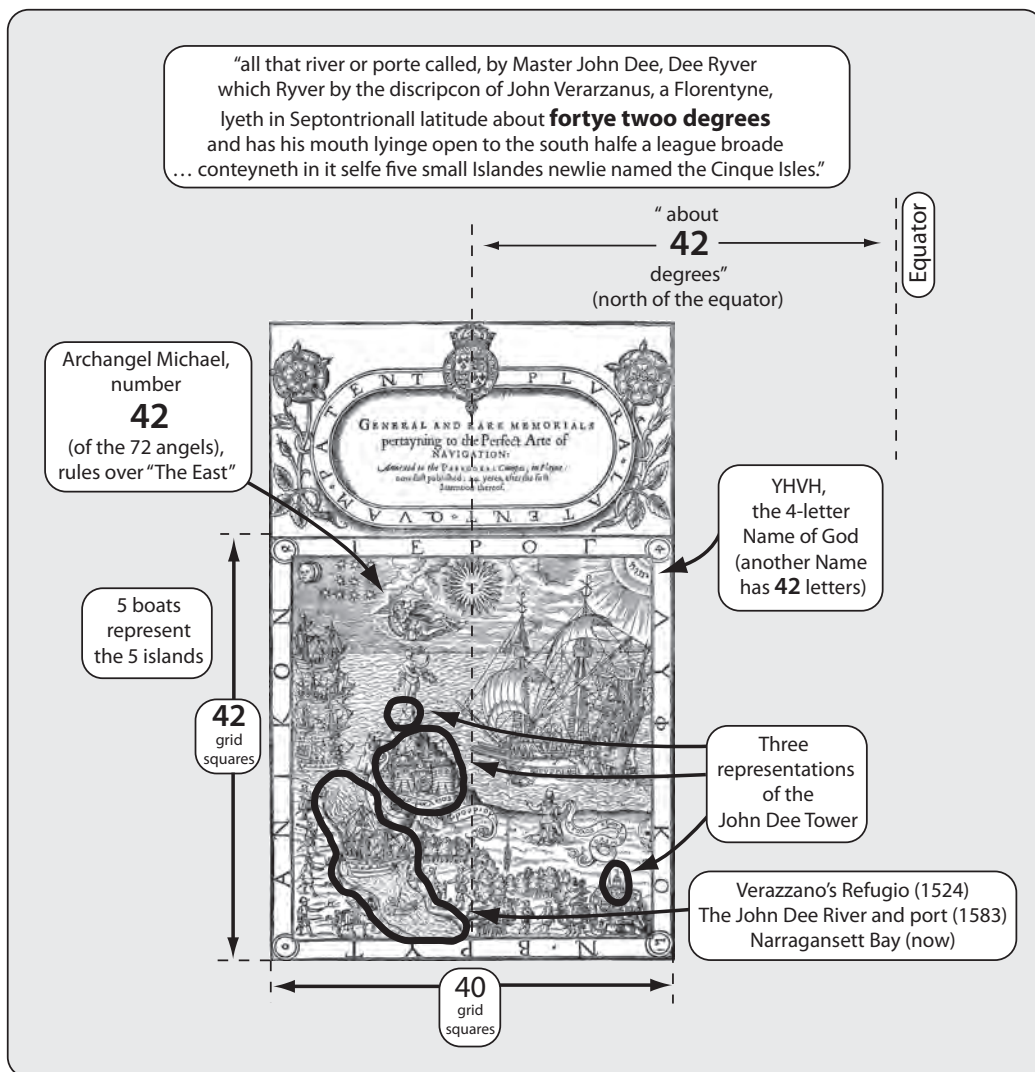

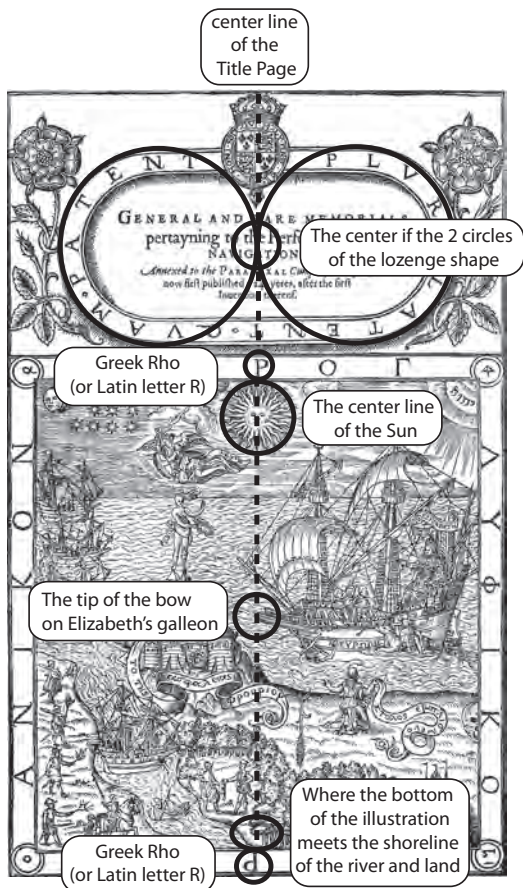

A closer look at the center line of the Title page shows that the river's location is not random. That centerline, the bottom of the illustration, and the shoreline of the river all meet at a common point.

That point joins several other important features that grace that centerline.

Knowing Dee's fondness for "oppositeness" and his knowledge of the flipped image in a camera obscura, it's not out of the question that he "flipped" his whole illustration left to right (along that vertical center line) to make it more cryptic.

Once it's flipped left to right it looks a little more like the layout of Newport. Now if the the mouth of the river is seen as "opening to the south" and the river is flowing somewhat from the "northeast," as per Verrazano's description

Verrazano also wrote that in the middle of the estuary leading to the sea was a "viva pietra" formed by nature, which is suitable for building any kind of machine or bulwark for the defense of the harbor. A "viva pietra" means a "non-porous, solid rock." (Verrazano, Wroth, p. 140)

This rock is most likely the high promontory at Bull Point on the southeastern tip of Jamestown. During the Civil War a huge fort was constructed there that no longer exists. (Verrazano doesn't note what side of the mouth it is on.) Perhaps it is the rocky promontory where the citadel and Lady Occasion stand.





# THE ANCHOR IS A SYMBOL OF THE MONAS SYMBOL

I propose that  
“John Dee designed the logo for the  
British Navy,  
the US Navy,  
and the  
State of Rhode Island.”

This is a pretty bold statement.  
Let’s look arguements pro and con.

The anchor shape actually evolved from the trial and error efforts of early sailors. A single hook (like a fish-hook shape) didn’t always catch something on the ocean floor. Two hooks were better, but they still needed to catch on a rock, making them useless in sand. So a thick heavy horizontal cross bar was added at right angles to the arms. As the heavy bar dragged along the bottom one of the flukes dug down, but the other fluke, pointing up, became useless.

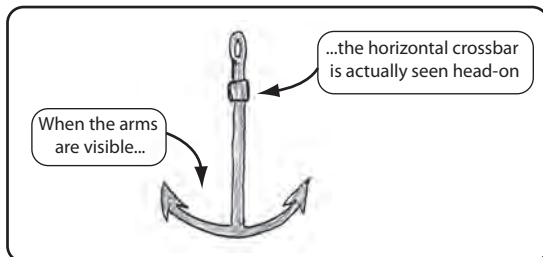
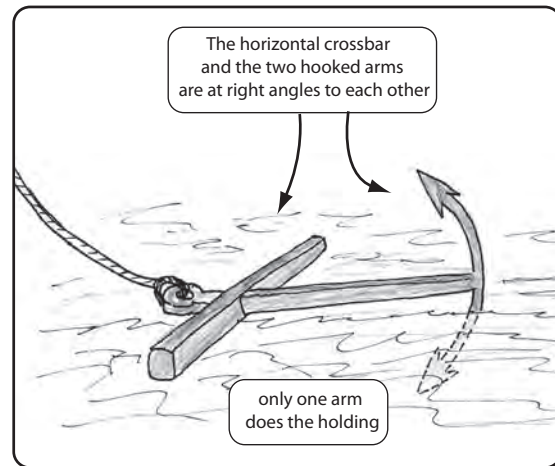

Thus the anchor symbol that we commonly see is actually drawn inaccurately. When the arms are seen, the horizontal crossbar is actually seen head-on, and hardly visible.

Dee didn't design the anchor nor was he the first to use it as a symbol for Hope. But what he did do was (cryptically) implement its use as a symbol for the New World Colonization effort and the British Navy. The idea of using it came from Dee's mind. He also was the most active in promoting its use by cryptically concealing it on the front cover of his *General and Rare Memorials*.

He didn't use it so its religious overtones would make the powerful English Church happy. He didn't use it to make the Lord Admiral or even the Queen happy.

He used it to represent his Monas symbol!

To Dee, (and to those "in the know"), it was a way of expressing the Monas symbol, without ever showing it.

Naval officers and Rhode Island residents might be outraged at the suggestion that the logo on their patches, buttons, and flags is actually some strange symbol designed by a Renaissance magus who hired a crystal ball reader to speak to angels. But they shouldn't be bothered by it. Indeed they should be grateful to understand its true meaning. (And also to understand why it has a fouled rope.)

The Monas symbol is a synthesis of Dee's mathematical and geometrical wisdom. It is his heartfelt description of Nature. It's as natural as the Earth's relationship with the Sun, the Moon, and the Elements. It's as natural as 1, 2, 3, 4 and the ratios 1:2, 2:3, and 3:4. It's as natural as the behavior of light in a camera obscura. And to understand these natural phenomena better should be mankind's greatest "hope."

***The Queen send Sir Humfrey Gilbert  
a gift to commemorate his colonizing expedition:  
an "Anchor of Hope"***

David B. Quinn located a letter from Sir Walter Raleigh to his half brother Sir Humphrey Gilbert, dated March 13, 1583, in which Raleigh writes that he is forwarding a gift from the Queen. It was a piece of jewelry depicting of a "anchor guided by a Lady."

**March 16, 1583 letter from Sir Walter Raleigh to Sir Humphrey Gilbert**

**"Brother—I have sent you a token from her Majesty,  
an anchor guided by a Lady as you see,  
& further her Highness willed me to send you word  
that She wished as great good hap and safety to your Ship  
as if herself were therein person...  
Further, She commandeth that you leave your picture ...  
Your true Brother,  
W Rauley"**

(my modernization of Sir Walter Raleigh's letter,  
in Quinn, *Voyages*, Vol. 2, Document 106, p.348)

Doing more historical digging, Quinn later found a letter from Maurice Browne to Thomas Tynne, dated sometime between April 28 and May 3, 1583 that describes the gift in great detail

Maurice Browne reports:

**“After Sir Humphrey had taken his leave of her majesty and gone down to Hampton, the Queen sent Sir Humphrey, as a token of her especial good favor, A very excellent Jewel.**

**The device was An Anchor of gold set with 29 diamonds with the Portrait of A Queen holding the ring of an Anchor in one hand the fluke of the Anchor in the other hand.**

**In the breast of which picture there is set A very great pointed Diamond, and in the Crown that stands on the head is set A very great ruby and at each end of the anchor a great pearl.**

**On the back side of the anchor is written as follows,  
Tuemur sub sacra ancora.  
[Be safe-guarded by the sacred anchor.]**

**Which Jewel doth hang at two chains devised with roses set with rubies and diamonds which was tied with two of her color [rose-colored or pink] tagged with gold and enamel and A scarf of white silk Cypress [a translucent fabric] edged with a fair lace of gold and silver.”**

(my transcription, from a letter written by Maurice Browne to John Thynne, written between April 25 and May 3, 1583, in Quinn and Cheshire, *The New Founde Land of Stephen Parmenius*, p.204-5)

Based on Browne’s description, I’ve drawn this conception of what it might have looked like:

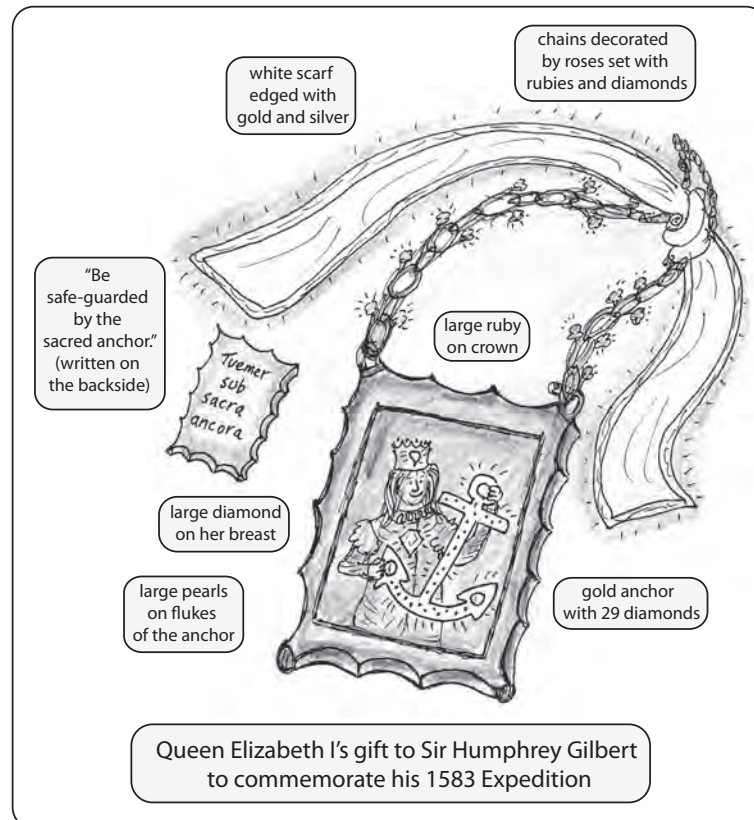



It's curious that Raleigh calls the subject of the portrait "a Lady" and Browne calls her "A Queen." Presumably, it's a portrait of Queen Elizabeth I herself, as she requests that Sir Humphrey send a portrait of himself as a return gift for her. Perhaps it is "Lady Occasion."

The most prominent feature of the Queen's gift is the anchor the Lady is holding in her hands

It's not a painting of an anchor, it's made from gold and studded with 29 diamonds. In conjunction with the adage written on the back "Be safe-guarded by the sacred anchor," this gift is clearly a representation of the Anchor of Hope theme.

This is the theme John Dee introduced in his 1577 *General and Rare Memorials* which was a major spark for the expedition and British nautical ambitions in general. But remember, in Dee's text and illustrations this Anchor of Hope theme is pervasive, but quite hidden.

In its own cryptic way, the Title page is saturated with Dee's mathematical cosmology from the *Monas Hieroglyphica*:

Metamorphosis (12, 24, and 72 hidden in the symbols in the sky),  
 Consummata (4 pyrologians, 4 ships and the horizon)  
 Point, line, circle, and zero-one ( $\alpha$ ,  $\zeta$ ,  $o$ ,  $\phi$ ),  
 Equinox, first of Aries (sun on the center line of the illustration)

And a huge part of the *Monas Hieroglyphica* is the Monas symbol itself.

Dee doesn't come right out and say "Monas symbol equals Anchor of Hope," but it's not a much of a stretch to put 2 and 2 together.

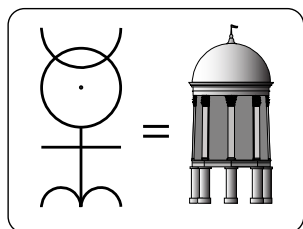
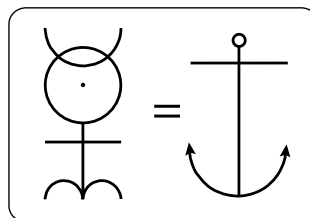

Likewise, nowhere does Dee say "Monas symbol equals the John Dee Tower," but its clear to me that he saw them as the same thing. They express the same powerful mathematical cosmology.

It's curious that Elizabeth's Anchor has 29 diamonds (29 is a prime number is an unusual number to select). If Sir Himpfrey Gilbert were to return his portrait holding an anchor with 29 diamonds (whether real or simply painted on), that would make a total of 58 diamonds. This is the angle of azimuth of the summer solstice sunrise in Newport (the angle from the Tower to the Redwood Library).

Dee would have known that at a latitude of "about 42 degrees" this sunrise line is "about 58 degrees." Whether Dee was involved in the design of the Queen's gift is not known, but it certainly seems to be following the Anchor of Hope theme instigated by Dee on his Title page with its "Send forth an expedition..in order to make steadfast watch-tower" exhortation.

There apparently is no record of Gilbert's return portrait, but he would surely not have ignored the Queen's request. The Queen's bejeweled gift is probably buried in the ocean floor off the coast of the Azores with the remnants of Gilbert's little ship, the Squirrel.

To summarize, the Anchor of Hope seems to have been the symbol for the Gilbert/Peckham/Dee colonizing voyage. And it sprouted in the mind of John Dee. His Title page of *General and Rare Memorials* is proof of that inspiration.

# SIX CLUES SUGGESTING BENEDICT ARNOLD KNEW HOW THE JOHN DEE TOWER WORKED

Here's how I see it. Governor Benedict Arnold knew all about Dee, the Monas Hieroglyphica, and the Tower. He (and others) knew all about the proposed colony at the John Dee River and port. He knew all about how the tower was Dee's architectural Monas Hieroglyphica. He knew it functioned as a camera obscura calendar and had astronomical alignments with the Sun and the Moon (at special times). But he didn't broadcast his knowledge, for fear that wealthy, influential men back in London would stake a claim on all the lands his family friends and neighbors had struggled so hard to settle.

Benedict was a powerful enough figure in New England to squelch any rumors that a fortress still existed from the Elizabethan days. One solution would simply be to destroy the Tower. But Benedict Arnold knew it was an architectural treasure, a historical monument that one day would be considered incredibly important. So while outwardly proclaiming the tower was simply "my stone-built windmill," he hid his knowledge in ways that would have made Dee proud.

Here are six clues that indicate he was well aware of the Tower's importance.



**Clue 1: Benedict Arnold's Mark**

He designed a clever mark that incorporated the size of the solar disc (2 1/8 inches), his initials (BA) and his knowledge of geometry (30-60-90 triangle) and inscribed it indelibly on the first governor's chair.

**Clue 2: Benedict Arnold's Seal**

Other early RI Colonists knew of Dee's tradition as well, as they adopted the Anchor Symbol as their emblem in 1647, before Benedict Arnold had moved to Newport. But it was Benedict who embellished the anchor with the fouled rope (to represent Dee's Aries symbol) in 1664 in his first act as an elected Governor.

The anchor is a "Monas dissimulata," a Monas symbol in disguise. Dee came up with this symbol of a symbol idea; Benedict embellished it and brought it to life.

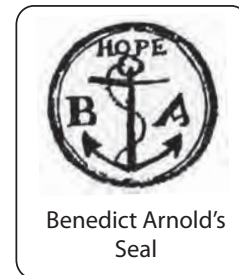

**Clue 3. Benedict and Damaris Arnold's nine children**

A clue as to how important the Tower and the "Anchor of Hope" were to Benedict Arnold can be found in the names he and Damaris chose for their children. They were all born over a 19-year period when Benedict Arnold was age 27 to age 46.

BENEDICT (JR.) 1642  
 CALEB 1644  
 JOSIAH 1646  
 DAMARIS 1648  
 WILLIAM 1651 (ONLY LIVED FOR 2 DAYS)  
 PENELOPE 1653  
 OLIVER 1655  
 GODSGIFT 1658  
 FREELOVE 1661

THE CHILDREN OF  
 DAMARIS AND BENEDICT ARNOLD

I've drawn a line after William because a month after he died the Arnold family moved to Newport.

Benedict and Damaris were named two of the early children after themselves. William is obviously named after Benedict's father. In 1551 Benedict was about to "break out of his father's shadow," relinquish his loyalty to the Massachusetts Bay Colony to help the citizens of Newport combat Coddington's power grab to make himself "Governor for life." Perhaps Benedict chose to name his son William to appease his father. (A cute, cuddly, namesake baby would melt any grandpa's heart.) Unfortunately, the baby William died two days after being born.

Do you notice anything peculiar about this list of names?

Excluding William, Penelope, and Oliver for a moment, the other names seem to seem to follow the first 9 letters of the alphabet. Only he letters A, E, and H are unaccounted for.

(There is no name starting with the letter I, but in Arnold’s time I and J were still considered to be the same letter)

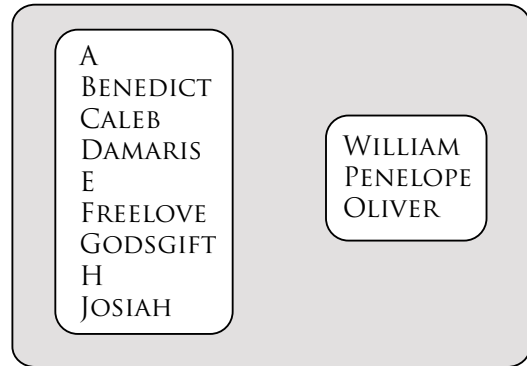

Penelope was a common name in Elizabethan times. Penelope Pelham (sister of Herbert Pelham) was named after the famous Penelope Devereaux. (The name has been around for a long time, at least since the Penelope who was Odysseus’ wife.) But the key clue is that “pEnElo-pE” contains three letter “E”s.)

It seems unlikely that with a last name like Arnold they wouldn’t give a baby double initials like Abigail Arnold, Arthur Arnold, Abraham Arnold. Most New Englanders were fairly conservative in naming patterns. Mostly, they named their children after themselves, their ancestors, or Puritan names like Patience, Mercy, and Chastity. Over half of the girls born in the early colonial days were named either Mary, Elizabeth, or Sarah.

The baby named william Arnold (Jr) at least had an “a” in its name, so let’s put it in the “A” position on this list. (Benedict might have also felt an “A” name was unnecessary because Arnold starts with an “A”)

This leaves Oliver, which unfortunately doesn’t have an “H” in it. Undaunted, I dug a little deeper.

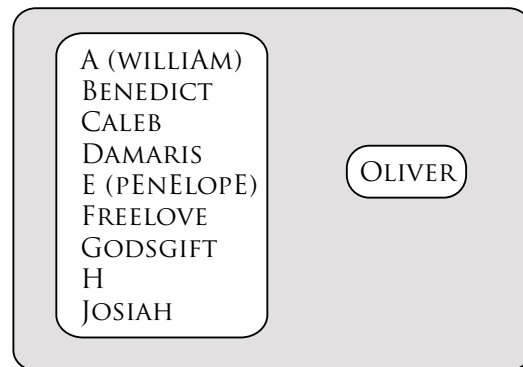

The Puritan leader Oliver Cromwell became Lord Protector of England in 1653 and held that position until 1658. Oliver Arnold was born in 1656, while Cromwell reigned.

With my American accent, when I pronounce the name Oliver, it sounds like it starts with an O. But with a British accent, especially 350 years ago, and doubly especially coming from someone anyone in the Arnold clan, with their with a broad West-Country accent, it would be pronounced “Holiver.” Put on your best British accent and you’ll see it sounds quite natural.

Here is a quote from an 1856 short story that plays with the letter H.

**“What was Holiver Cromwell but a brewer of good stout,  
and suckled on ‘Untingdon ale?  
And did he not afterward cut off King Charles’ ‘ead,  
when he had pulled him by the ears out of the royal hoak  
where he was a hiding the Magna Charta from the people.”**

*(The Old House of Dark brothers, Little’s Living Age, Boston 1856)*

(The author has added an “H” to Oliver, oak, and Carta;  
plus he has deleted an “H” from Huntingdon and head.)

Holiver and Oliver have both been common last names in Kent, England for generations. Kent is on the coast opposite France so it's most likely the French "H" got dropped. It's much like the name Arnold itself, which comes from "Arnault," or another version, "Harnault," which also descended from French ancestry.

And if Benedict Arnold was familiar with John Dee's *Monas Hieroglyphica* and his *General and Rare Memorials* Title page illustration of IEROGLYPHIKON BRYTANIKON, he would be aware of playing letter "H" games. (Remember that Dee also put an H in the front of Hierusalem.)

But just as we found the word "HOPE" in Dee's Greek letters "IEPOΓ..." from IEROGLYPHIKON BRYTANIKON, I think Benedict was playing the same game with his children's names.

In 1651, Benedict Arnold shifted his loyalty from the Mass. Bay Colony to help his fellow settlers on Narragansett Bay rally together to build an independent state.

He embraced the idea of HOPE, and he wanted it to be passed on to future generations. Penelope was born first (1653), then Oliver was born shortly thereafter (1655). Had Penelope been a boy, I think he would have been called Oliver.

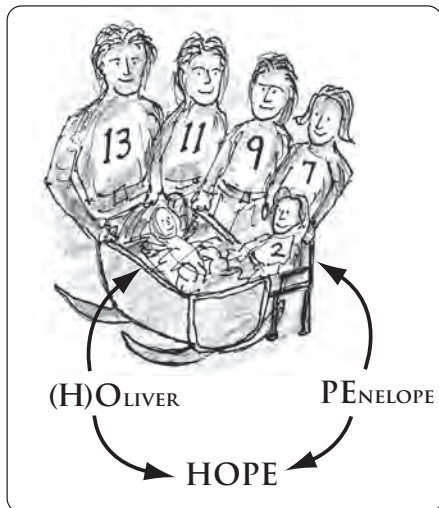

Picture the scene in Benedict Arnold's household in 1655. Four children ages 13, 11, 9, and 7 fawning over a new born Oliver and a two-year-old Penelope.

**Combine the beginning sounds of the babies names and you've got "HOPE"!**

Benedict Arnold didn't play this game simply for his own colonial day yuks. (His wife would never let him.) He did it because he was carrying on the tradition and the metaphor John Dee used in the Title page of *General and Rare Memorials*. It seems as though Benedict Arnold had a copy of this text and had as much fun decoding the cover as we have had.

A (WILLIAM)  
BENEDICT  
CALEB  
DAMARIS  
E (PENELOPE)  
FREELOVE (1661)  
GODSGIFT (1658)  
H (OLIVER)  
JOSIAH

Further support for this idea comes from the fact that he named his last two children with names starting with G, and F, the two "missing" letters in his sequence.

***More on “Gud’s Gift” and “Vree-luv”( with British accent)***

Note that he did not name these last two names in alphabetical order (meaning F first, then G). The name Godsgift speaks loudly about the letter “G”, being made from two short words each beginning with a hard “G” sound. But is also contains an “F.” In the event Benedict and Damaris might not be able to produce another child (they were both about 43), they already completed their alphabet game somewhatwith GodsGiFt.

It was a bonus when Freelove was born, she filled in the missing “F.” In the West Country accent, an initial “F” in a word is sort of pronounced like a V, as in “varmer Joe grew vig trees.” So Freelove would be pronounced “Vree-luv,” an alliterative word like Godsgift.

To visually synthesize some of the themes, here is Benedict Arnold’s mark on the Governor’s chair (emphasizing his initials), his Governor’s seal (1663) and two of his children (Oliver and Penelope pictured in 1655 when Oliver was a baby and Penelope was 2 years old).

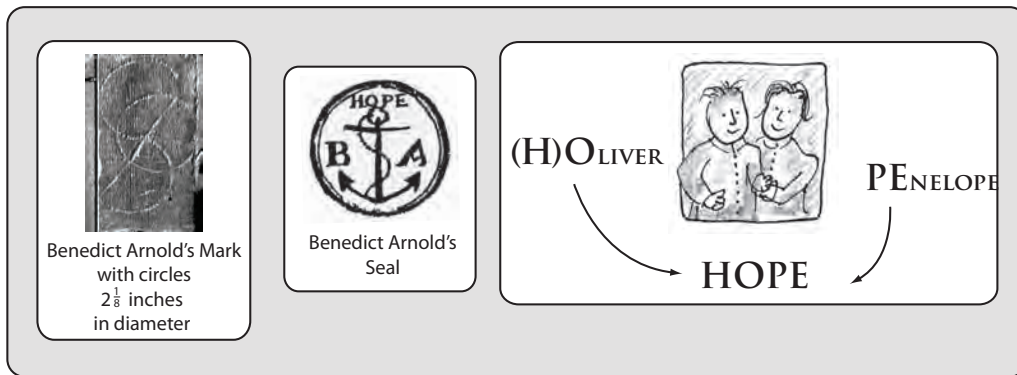

Playing with alphabet-name games was not a common practice in colonial days. Benedict was clearly an independent thinker, and he was probably influenced by another independent thinker and lover of alphabet letters, John Dee.

***Clue 4: Benedict Arnold’s “east-west line” and the Metamorphosis numbers***

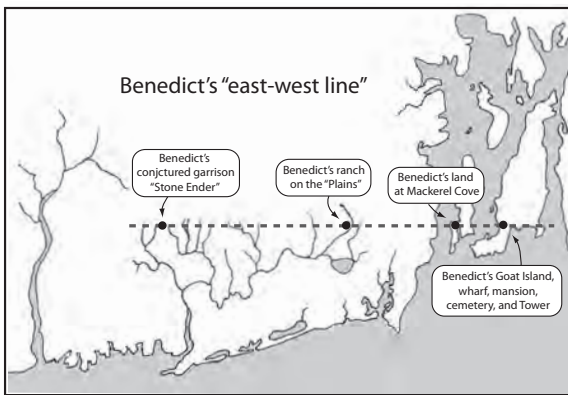

I explained earlier how many of Benedict Arnold’s properties align on the “east-west” line. The Tower, his cemetery, and his Mansion are on a line just slightly north of due west, but the Tower, Goat Island, his son’s House on Beavertail in Jamestown, his plains ranch in West Kingston, and his Garrison house in the Western border of Rhode Island are on an east-west line.

Several of these properties have an interesting relationship: Their distances express Dee’s Metamorphosis number sequence: 12, 24, 72, 360, and 2520.

If the distance between the Tower and Benedict's family cemetery is 12 units, the distance from the Tower to the Mansion is double this or 24 units. (In his will, Arnold describes the cemetery as being "in or near ye line going from my Dwelling house to my Stone-Build Wind miln")

Using the same scale, the distance from the Tower to the highest point (and probably a fort) on Goat Island is 72 units. (Benedict and one associate purchased Goat Island from the Indian leaders and later gave it to the City of Newport.)

Again using the same scale, the distance from the Tower to his son's house at the north end of Beavertail is 360 units.

And finally, the distance from the Tower to (what I believe to be) his Garrison House on the westernmost edge of the lands of the Providence Plantations Charter of 1644 is 2520 units. Benedict has woven the Metamorphosis numbers across Southern Rhode Island!

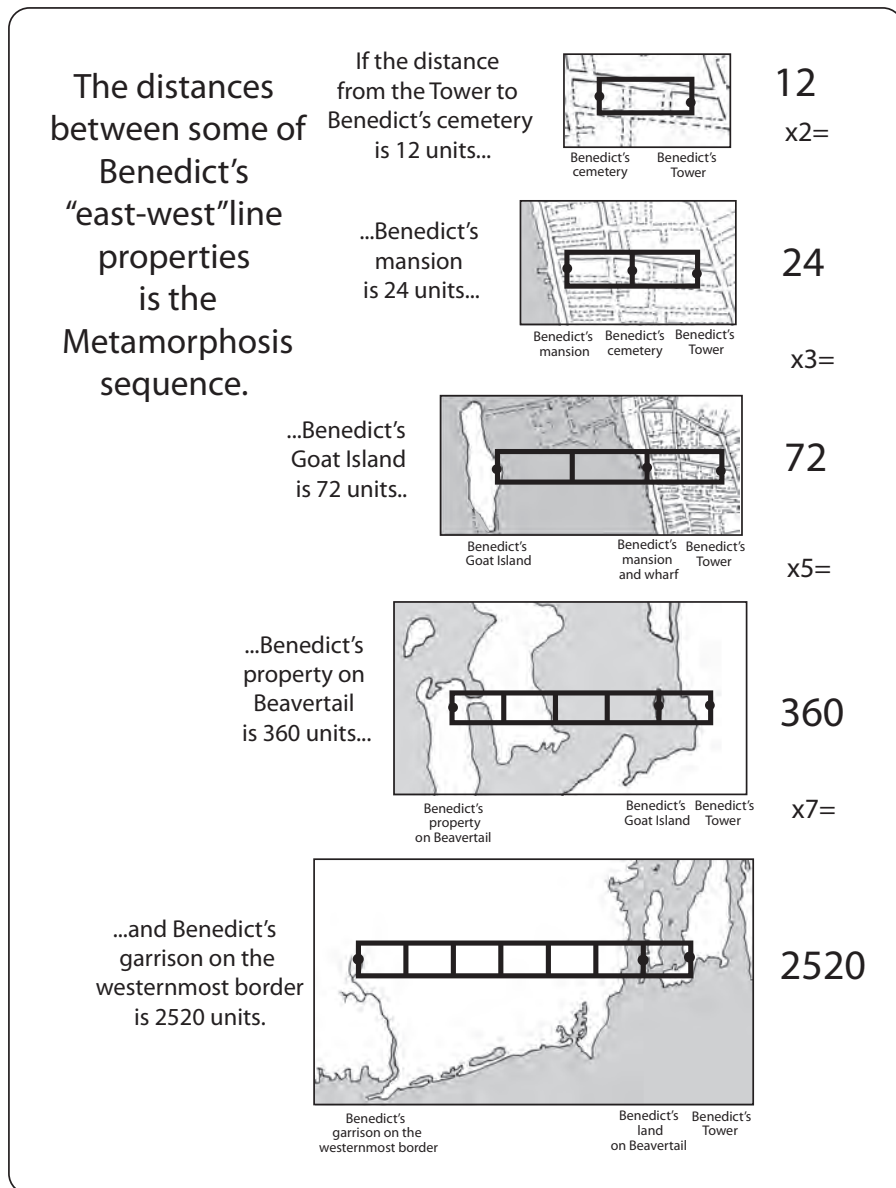

Could this all be accidental? Perhaps, but in light of some of his other cryptic clues (his mark, the Anchor Ring, his children's names) it's quite feasible that it was done with intent.

The positions of the Tower, Goat Island, and Beavertail were "givens," but Benedict himself decided where his house, his mansion, and his western Garrison should be located.

Though his "Plains ranch" in West Kingston is not a part of this "numbers game," the fact that Benedict selected a parcel of the Pettasquamicut Purchase that was on his "line" lends further support for this idea.

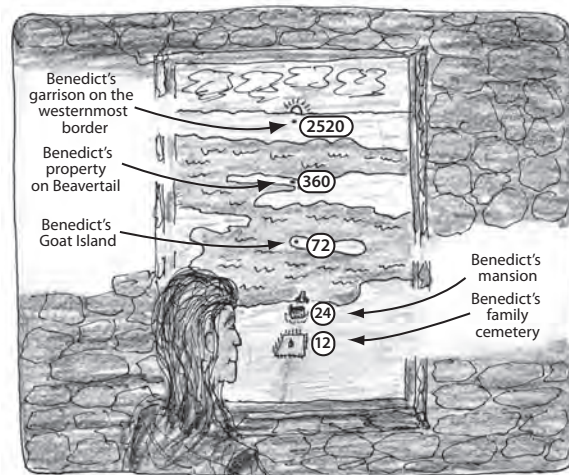

Benedict looking out the West window of the Tower at the "Metamorphosis" arrangement of properties

### *The size of John Dee's intended colony was to be 2520 square miles*

John Dee played a similar "numbers game" by defining the size of the 1583 colony at the John Dee River to incorporate 2520 square miles. Besides providing telling details of the location, he also gives some distances involved in the Gilbert/Peckham agreement of February 28, 1583.

**"... all that river or port called by Master John Dee, Dee River, which River, by the description of Giovanni Verrazzano, a Florentine, lies in the Northerly latitudes about 42 degrees**

**and has its mouth lying open to the South, half a league broad or thereabout, and entering within the said Bay between the East and the North increases its width and continues 12 leagues or thereabouts, and then makes a gulf of 20 leagues in circumference or thereabouts, and contains within it 5 small Islands, newly named the Cinque Isles**

**And the said gulf and the 5 Isles at the choice of the said George and George his youngest son, their heirs, deputies, or assigns or any of them."**

Further on in the document is this description of the whole parcel:

**"...Fifteen hundred thousand [1.5 million] acres of ground extending along the sea coast westward towards the River of Normbega [probably the Hudson River] not more that 60 English miles in length..."**

(my modernization; Quinn, Voyages, p. 343)



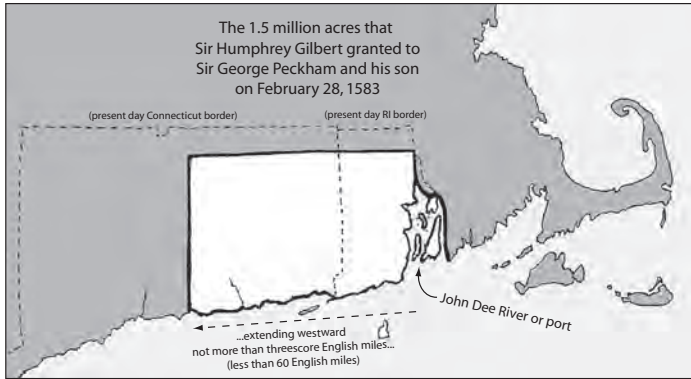

Here is a map of the Gilbert/Peckham/Dee colony overlaid on a map showing modern-day state boundaries.

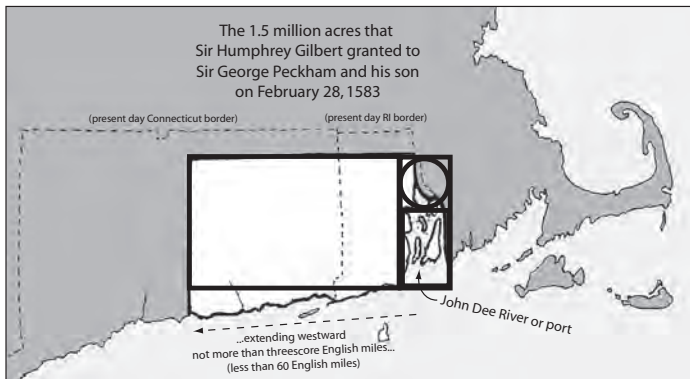

For a simpler geometric analysis, let's convert these areas into rectangles and circles. The gulf is a circle, its entranceway is a vertical rectangle, and the overall shape is a horizontal rectangle.

Dee disguises the measurements by providing them in "leagues" and "miles."

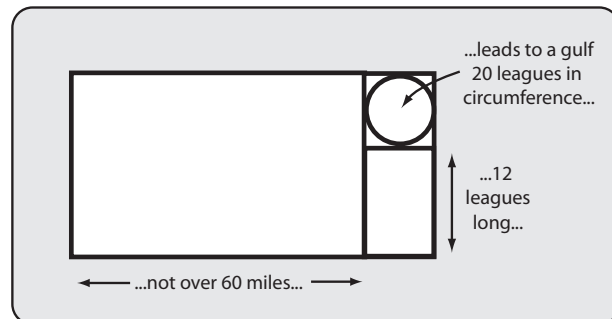

Dee's boundary description in leagues (and miles)

Using the conversion factor of 1.91 English miles equals 1 French league or "French *petit lieue*," let's convert all the measurements into miles.

(Dee was using Verrazzano's measurements and Verrazzano was on a mission for the King of France.)

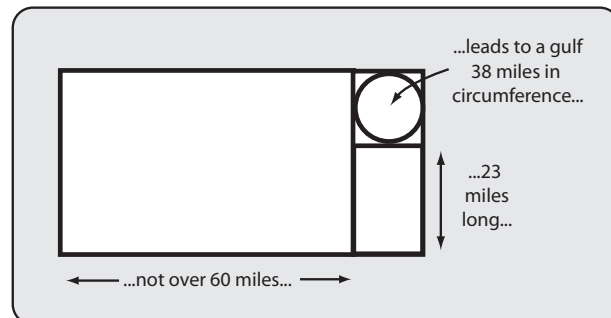

Dee's boundary description converted into miles

1 French league = 1.91 English miles

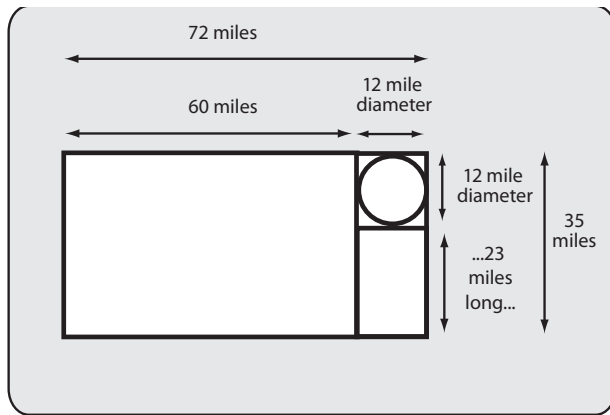

A circle with a circumference of 38 miles has a diameter of approx. 12 miles

Multiplying  $35 \times 72$  makes 2520, Dee's "Sabbatizat"!

This particular pathway to 2520 ( $35 \times 72 = 2520$ ) is quite important because it involves another Metamorphosis number, 72.

As the gulf has a circumference of 38 miles, it has a diameter of 12 miles. So the total height is 35 miles ( $23 + 12$ ). And the total height is 72 miles ( $38 + 12$ ).

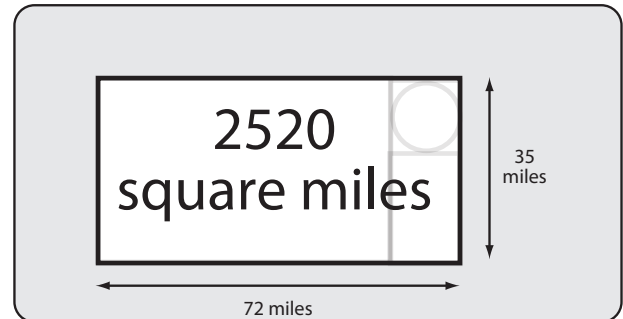

$35 \text{ miles} \times 72 \text{ miles} = 2520 \text{ square miles}$

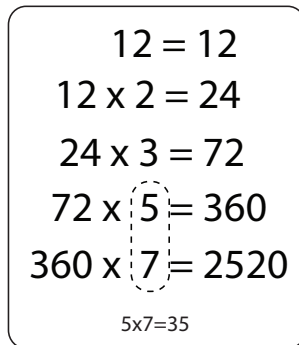

The other number, 35, combines the 5 from the ( $5 \times 72 = 360$ ) step and the 7 from the ( $7 \times 360 = 2520$ ) step.

(There another great path to 2520, with which this one is mathematically entwined: ( $36 \times 70$  equals 2520).

This path is very similar to the ( $360 \times 7 = 2520$ ) step in Metamorphosis.)

(In another amazing correlation, Dee says the latitude is "about 42 degrees." He also says that the width of the parcel of land is "not over 60 miles." Admittedly these are both estimates, and also, one is in degrees and the other is in miles. But multiplied together,  $42 \times 60$  makes 2520!)

Certainly I have done some rounding off in my calculations, and the water- and land-forms involved are far from round and rectangular. But this is how Dee would have approached it. The colony was a concept. It came from his mind. Just as the tower sang perfect harmony, the overall colony was to be mathematically harmonious as well.

Dee determined its location and most likely is size. All this helps explain why he used the approximation "not more than 60 miles in length."

As there are 640 acres in a square mile, 2520 square miles actually contains about 1.6 million acres. This is pretty close to the deed's 1.5 million acres. (Put another way, 1.5 million acres is 2343 square miles, which is only 177 square miles shy of 2520)

### **Why did Dee want a colony of 2520 square miles?**

Just as 2520 is the lowest number divisible by 2, 3, 4, 5, 6, 7, 8, and 9, the colony would be the smallest possible size colony that could be divided into halves, thirds, quarters, fifths, sixths, sevenths, eighths, or ninths (or even tenths or twelfths). This would allow for a variety of options in governmental affairs like voting representation and land distribution.

Plato's ideal city (in Book 5, 737-8 of *Laws*) was to have 5040 citizens for the same reason. The number 5040 (which is simply 2 x 2520) provides for many ways to divide the whole populace.

### ***Clue 5: Benedict and his associates signed the land agreement for Jamestown Island on the Spring Equinox***

On the Spring Equinox, the first day of Aries, the sun sets exactly due west, along Benedict's line. The farthest point on the line, Benedict's garrison house, would not be visible, as it was 30 miles away. But the southern tip of Jamestown and Beavertail would be clearly visible especially because the sparkling "firewater" reflections off the water's surface would silhouette the various land forms in the hours before sunset.

As the colonists used the Julian Calendar, this equinox event would have taken place on March 10.

March 10 (1657) is the precise date that over 80 colonists, including Benedict Arnold and William Coddington, signed a 7-page land agreement to purchase Quononaquutt (Conanicut Island or Jamestown). (A magnanimous donor purchased this document in an artifact auction in 2005 and donated it to the Jamestown Historical Society.)

The Indians had been allowing the colonists to use the island for grazing animals since 1637 and was presumably it was clear, open pastureland. About a month after the colonists' agreement, (on April 15, 1657) the sagamore Cojonoquant actually deeded them the land. Benedict was a key player in the deal and got much more land than anyone else – over 1000 acres – along the whole southern coast of the island, including Beavertail. (Rider, *Lands*, p. 145)

It's curious that they signed their agreement on the equinox. The date of March 10 caught my attention as a result of having read James Mavor and Byron Dix's groundbreaking book *Manitou*.

They had noticed that in 1620 the Pilgrims landed in Plymouth on the day of the winter solstice. The Mayflower was actually still in Provincetown, but a group of men took a shallop to explore the coast of the large bay to find a more suitable mainland harbor.

On a Thursday night they were in Eastham. By Friday they were on Clarke Island in Plymouth harbor. But there the company seems to have dallied unaccountably "all day Saturday and all day Sunday. Mavor and Dix suggest they wanted to land at Plymouth on Monday as it was the Winter Solstice and the natives were expected to be gathered at their sacred places celebrating the winter solstice feast of dreams festival, and therefore less likely to threaten the landing."

They found that eight of the reported nine principal episodes involving contact with the Indians can be connected with solar events. Five of these occurred precisely on days of solstices and equinoxes, and three others occurred shortly after the equinox.

Mavor and Dix calculated that in 1620 those dates (in the Julian Calendar) were:

Winter Solstice December 11, 1620

Spring Equinox March 10, 1620

Summer Solstice June 11, 1621

Fall Equinox September 13, 1621

*(Add 10 days to find the Gregorian Date)*

*(Mavor and Dix, Manitou, p. 147-8 and 356-7)*

My conjecture is that perhaps these dates were important to the Pilgrims themselves. Regardless, it's clear the Pilgrims were cognizant of these solar events.

The date of the equinox can vary a day or so either way from the (Gregorian) March 21 date that I have used as a generalization in this text. Even with that flexibility, the odds that Benedict and the 80 men would just happen to congregate on the Spring Equinox are about 1 in 100.

### ***Clue 6: The Date of Benedict Arnold's Will***

Benedict's Will begins:

**"1677, December 24: The Will of Benedict Arnold**

**By Permission of God Almighty**

**I Benedict Arnold of Newport in the Colony of Rhode Island  
and Providence Plantations & Senior Aged Sixty and two years**

**finding my self subject to weaknesses and infirmities**

**The usual attendants on aged Persons**

**and Considering my Days are not like to be many**

**that I have to abide in this Temporal life ..."**

Benedict was born on December 21, 1615. So when he wrote the will he was 62 years and 3 days old. It's understandable that he wouldn't want to write his will on his birthday, or the day after, but maybe the event triggered him to call in his lawyer. (Colonial people didn't celebrate Christmas)

Being cognizant of all that Benedict knew about Dee, the *Monas*, and the Tower, it seems as though he might have chosen the 24th Day of the 12th month to cryptically refer to those two special numbers. They are the first two Metamorphosis numbers, "hours of the day and night of the Equinox" numbers, the "vertices and edges of a cuboctahedron" numbers, and the "radius and diameter of the John Dee Tower" numbers (in feet.) And on the second page of that document is where refers to "my Stone-built Wind Mill," (probably with his fingers crossed behind his back).

To conclude, any of the foregoing 6 clues might be considered conjectural, but added together they start to paint a clear picture that the richest and most powerful man in the colony knew about Dee's Tower, as well as Dee's mathematical cosmology.

### ***Dee's use of the Anchor, religious freedom, and Americans today***

The fouled anchor continued to be a symbol for the British Navy from the Elizabethan days of John Dee and Charles Howard to the present. The United States Navy and the Canadian-Navy both derived their symbols from the British Navy.

Though Dee was drawing on a long tradition that goes back Hebrews 6:19, it was his encapsulation of this symbol in his 1577 *General and Rare Memorials pertaining to the Art of Navigation* that started its use in naval affairs. Sir Humphrey Gilbert was not a Lord High Admiral. Even the Queen even felt he wasn't a very skilled mariner. But still he managed to obtain to exclusive rights to North America.

And Gilbert gave Dee most of what today is Canada for his vital assistance. Dee provided the legal and historical proof of England's right to North America. He was the chief promoter cheer-leader of the project in his meetings with the Queen and the Privy Council. He designed its first building, the Tower that still stands today. He named the settlement the John Dee River and port after himself. To suggest that he also conceived of the "Anchor of Hope logo" for the whole project is not outlandish at all.

The proof that he designed the John Dee Tower is in the *Monas Hieroglyphica*. The proof that he designed the "anchor" symbol that was used by Gilbert (in 1583), Lord Howard (in the late 1500's), and adopted by Rhode Island settlers (in the mid 1600's), is in the Title page of the *General and Rare Memorials*.

Dee had a personal conviction to bring religious harmony to Europe in an era when Protestants and Catholics were clashing. Few historians seem to appreciate Dee's impact on the Western World. Few mathematicians seem to appreciate his keen understanding of geometry and number. But by studying his written works and his one architectural achievement, mankind will gain deeper insights into how Nature works.

Even though the British Empire grew wildly ambitious and exploited many people in other lands, Dee's original intent for the empire was to spread knowledge and wisdom throughout the world.

Bucky reminded us that we are all fellow citizens on Spaceship Earth. Dee thought even grander. He reminds us we are all "Cosmopolites," a term he coined from cosmos (world) and politês (citizen). A Cosmopolite is "A citizen, and Member, of the whole and one Mystical City Universal." (Dee, *General and Rare Memorials*, p. 54 and O.E.D. p. 568)

Dee recommends that a Cosmographer (one who studies Heaven, Earth, and their inter-relationships) should meditate on the "Cosmopolitical Government thereof," (which is ultimately "under the King Almighty").

Dee built the Tower not only as a gift to the Elizabethans, but to the whole world. He designed it to last for generations (which it has.) He knew that any man would consider it beautiful as it is simply a reflection of "Natures Laws" – which will never change.

The John Dee Tower is not just a Rhode Island State Treasure, or a National Treasure, or even an International Treasure. It's a Universal Treasure, which reflects Nature as seen through the eyes of a brilliant man.

#### Bibliography

Mavor, James W. and Dix Byron, *Manitou The Sacred Landscape of New England's Native Civilization* (Rochester Vt., Inner Traditions, 1989)

Quinn, David B. and Cheshire, Neil M., *The New Founde Land of Stephen Parmenius*, (Toronto, Univ. of Toronto, 1972)

Raz, Uri, <http://www.tarot.org/il/English/Forty%20Two/>