

**ST. JOHN THE BAPTIST CEMETERY
PINE STREET & BATH ROAD
BRUNSWICK, MAINE
CUMBERLAND COUNTY**

**Volume 1 of 3
Ranges 1 through 8**

Donald & Mark Cheetham, 2007 - 2009

929.509741
.C515
stj
2009
v.1

St. John the Baptist Cemetery

St. John the Baptist Cemetery is located between Pine Street and Bath Road in Brunswick, Cumberland County, Maine and is known by most simply as St. John's Cemetery. It is situated on the north side of Pine St. and the south side of Bath Rd. bordered by the Brunswick Naval Air Station on the east side and Varney Cemetery on the west side. The cemetery consists of 3,643 stones, the earliest dated 1854, is completely fenced and is still very active. A flagpole is situated near the center of the cemetery and about its base are stones representing the cemetery, the citizens of Brunswick, Elks, American Legion and Knights of Columbus. A maintenance building is located off Pine Street and the Ste. Marie family crypt is located near the center of the cemetery.

This record of St. John the Baptist Cemetery is dedicated to Judy Souther, the sextant of St. John the Baptist Church and caretaker of this cemetery, in recognition of the improvements she is making to these hallowed grounds as well as the valuable assistance she provided in connection to this record.

Contents

Volume 1 of 3 (Range 1 through 8)

- 1) Map illustrating the general arrangement of the cemetery.
- 2) Maps indicating the numbering of the ranges and detail maps.
- 3) Detail maps indicating the placement of the individual stones and markers by range.
- 4) Record of each individual stones inscription.

Volume 2 of 3 (Range 9 through 17)

- 5) Detail maps indicating the placement of the individual stones and markers by range.
- 6) Record of each individual stones inscription.

Volume 3 of 3 (Range 18 through 20)

- 7) Detail maps indicating the placement of the individual stones and markers by range.
- 8) Record of each individual stones inscription.
- 9) Additional cemetery burials.
- 10) Translations
- 11) Index by family name giving the location in the cemetery corresponding to the maps and text.

Note

Numbering of the markers is only as an aid in locating the stone within the context of this survey and do not represent any town or cemetery association designation.

Detail maps indicate monuments and marker stones by a dark outline. A double line indicates the side which the marker stone or monument is inscribed. No double line indicates that the inscription is on the top surface of the stone.

Type of marker, be it Marble, Granite, Metal or Concrete is indicated on the detail maps for the cemetery. M = Marble, G = Granite, Mtl. = Metal, Conc. = Concrete.

This record of St. John the Baptist Cemetery was produced by Donald Cheetham of Brunswick, Maine and Mark Cheetham of Richmond, Maine 2007 - 2009.

Southwest Portion

WEST

PINE ST.

Range #1

#2

Range #4

Range #5

Range #6

#3

Range #7

Range #8

Range #9

Range #18

SOUTH

Range #11

Range #12

Range #13

#17

#14

Range #15

Range #16

Range #10

Range #19

Range #20

BATH ROAD

EAST

Northeast Portion

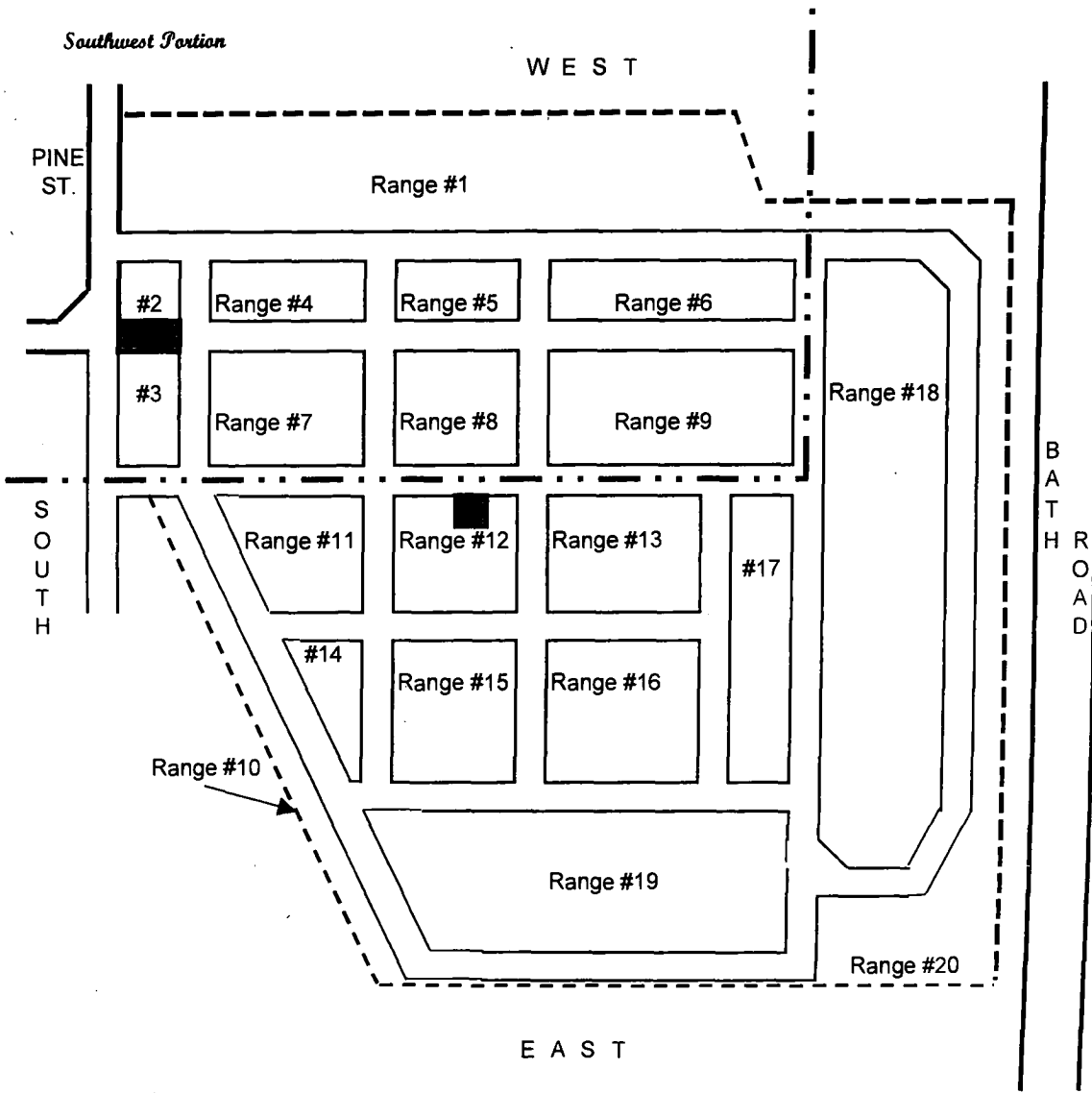

ST. JOHN THE BAPTIST CEMETERY - General Arrangement

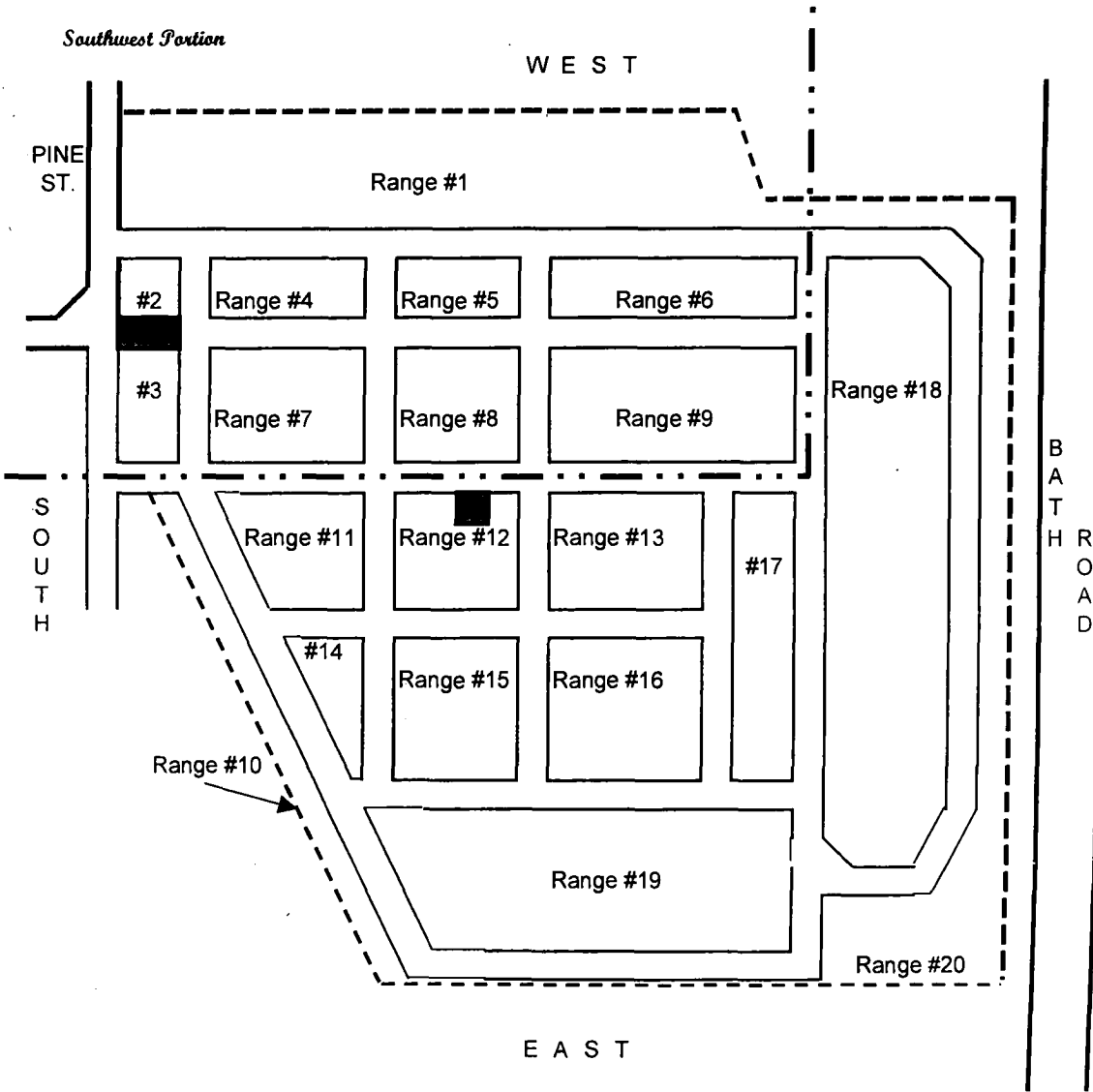

Northeast Portion

ST. JOHN THE BAPTIST CEMETERY - Detail Map Arrangement

Southwest Portion

WEST

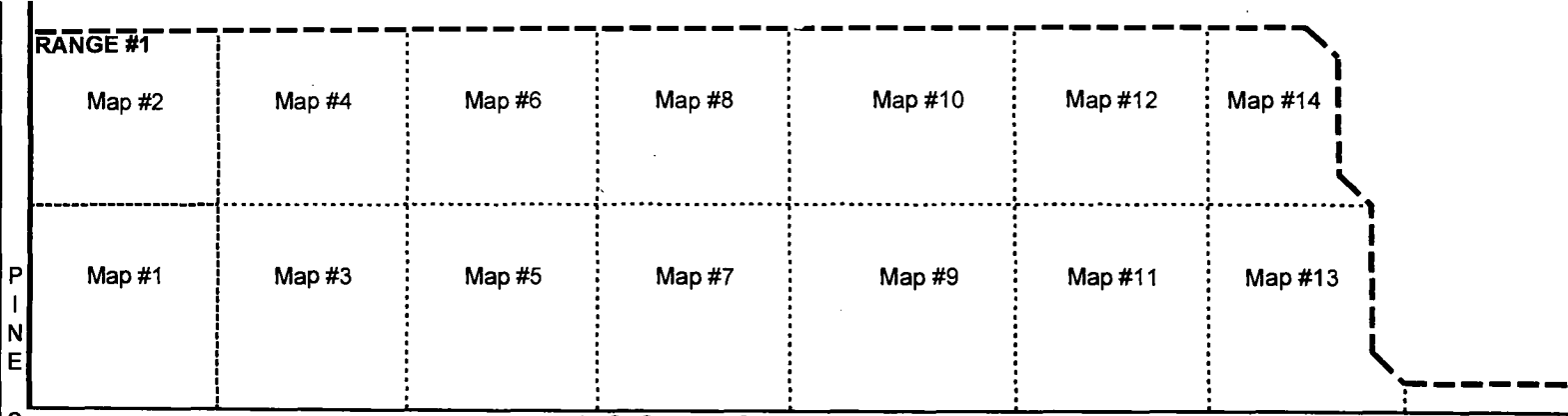

A C C E S S R O A D

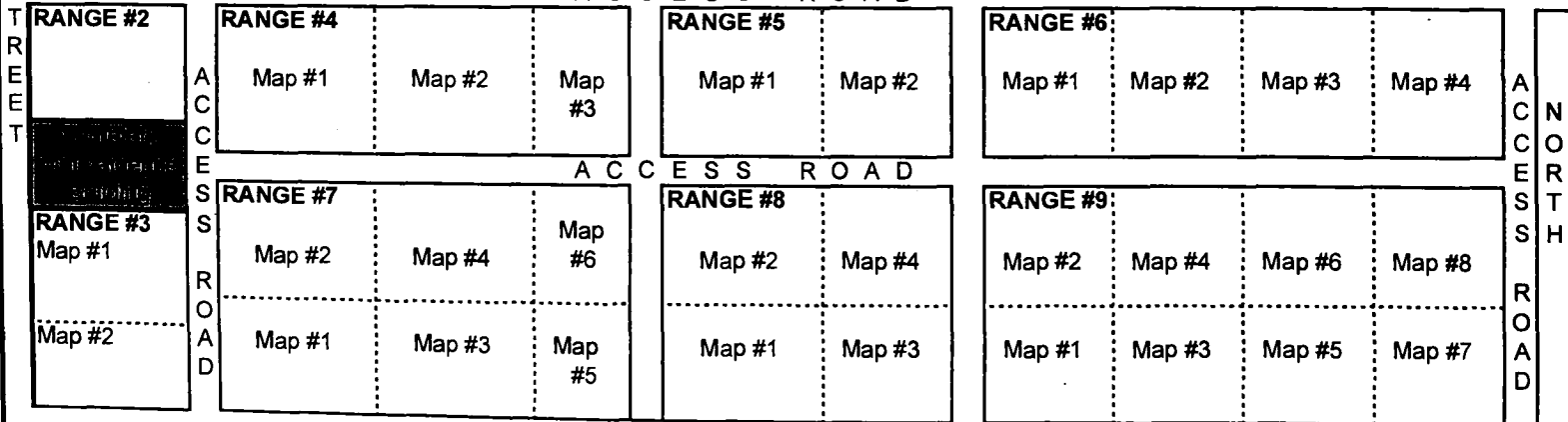

A C C E S S R O A D

EAST

P I N E
S O U T H
S T R E E T

A C C E S S
R O A D

A C C E S S
R O A D



ST. JOHN THE BAPTIST CEMETERY - Detail Map Arrangement

Northeast Portion

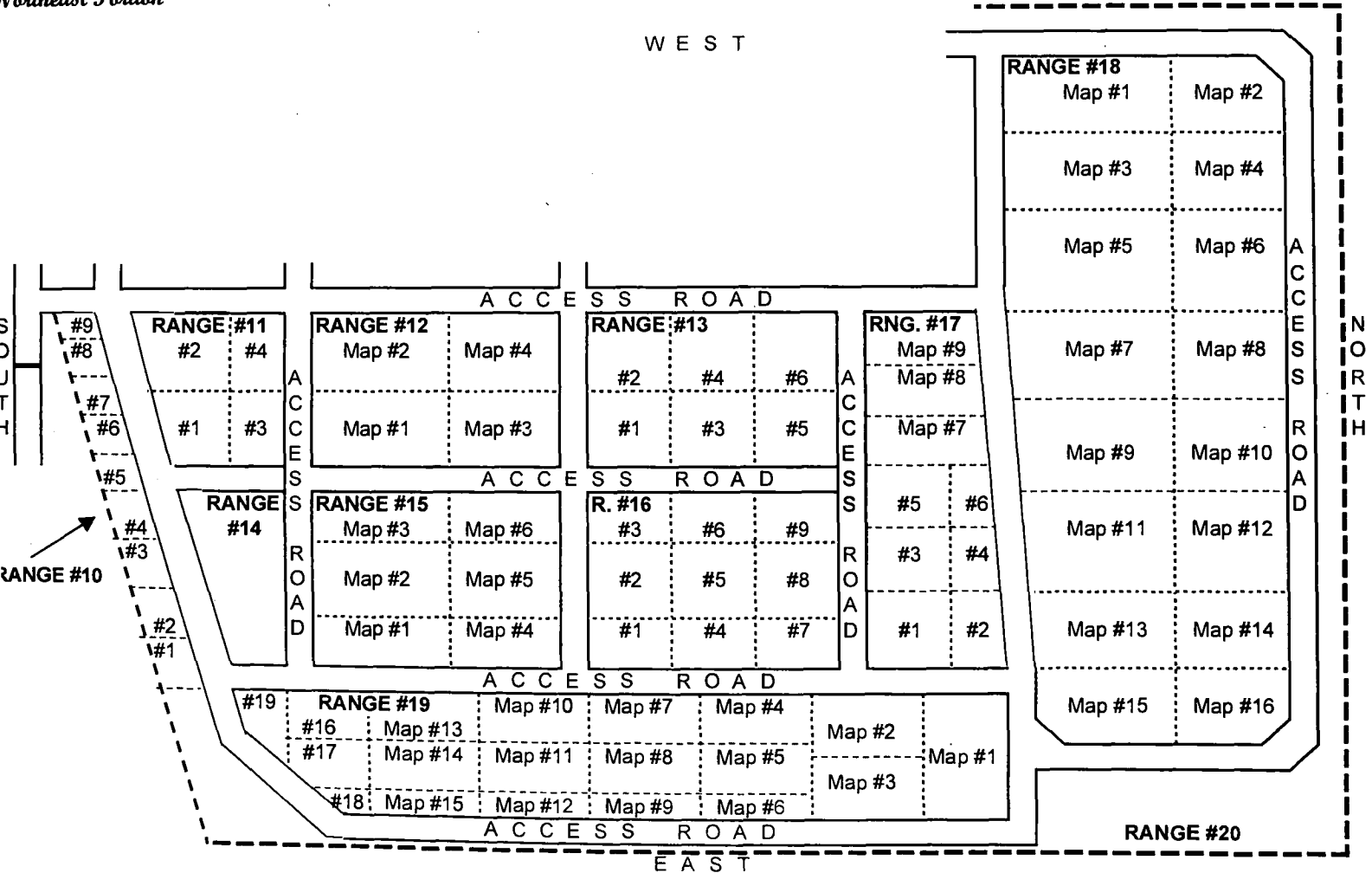

ST. JOHN THE BAPTIST CEMETERY - Range Layout

RANGE #1
Map #1

W E S T

P
S
I
O
N
S
O
U
T
R
E
E
T

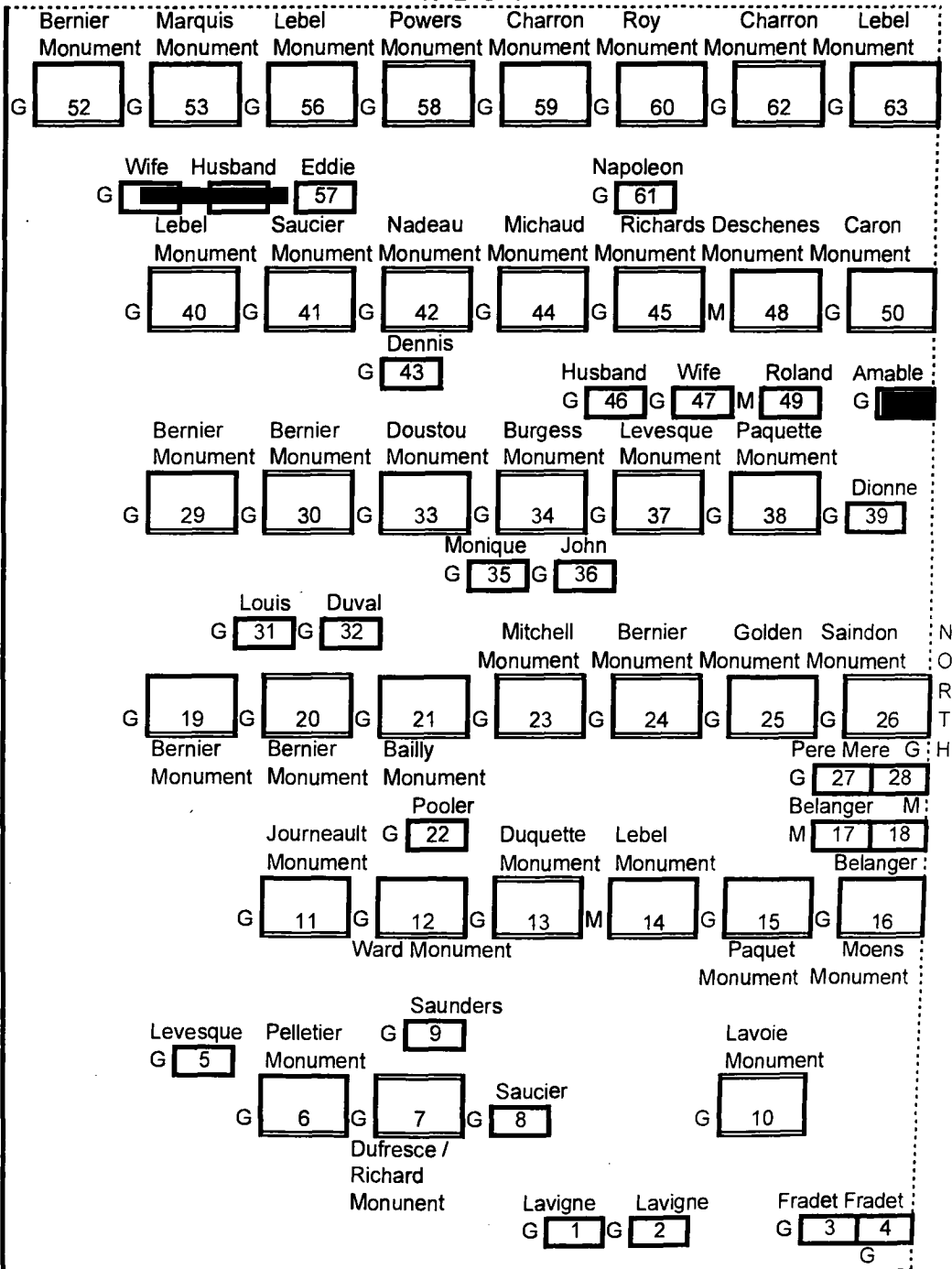

A C C E S S R O A D

E A S T

ST. JOHN THE BAPTIST CEMETERY - Range Layout

RANGE #1
Map #2

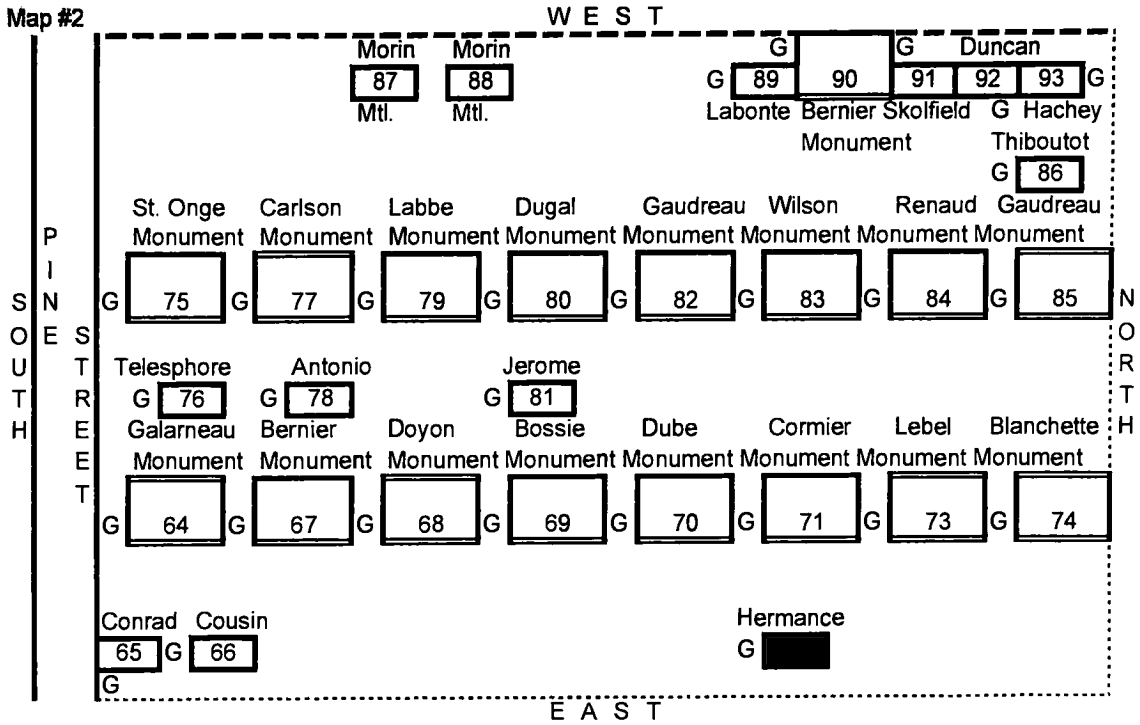

ST. JOHN THE BAPTIST CEMETERY - Range Layout

RANGE #1

Map #3

W E S T

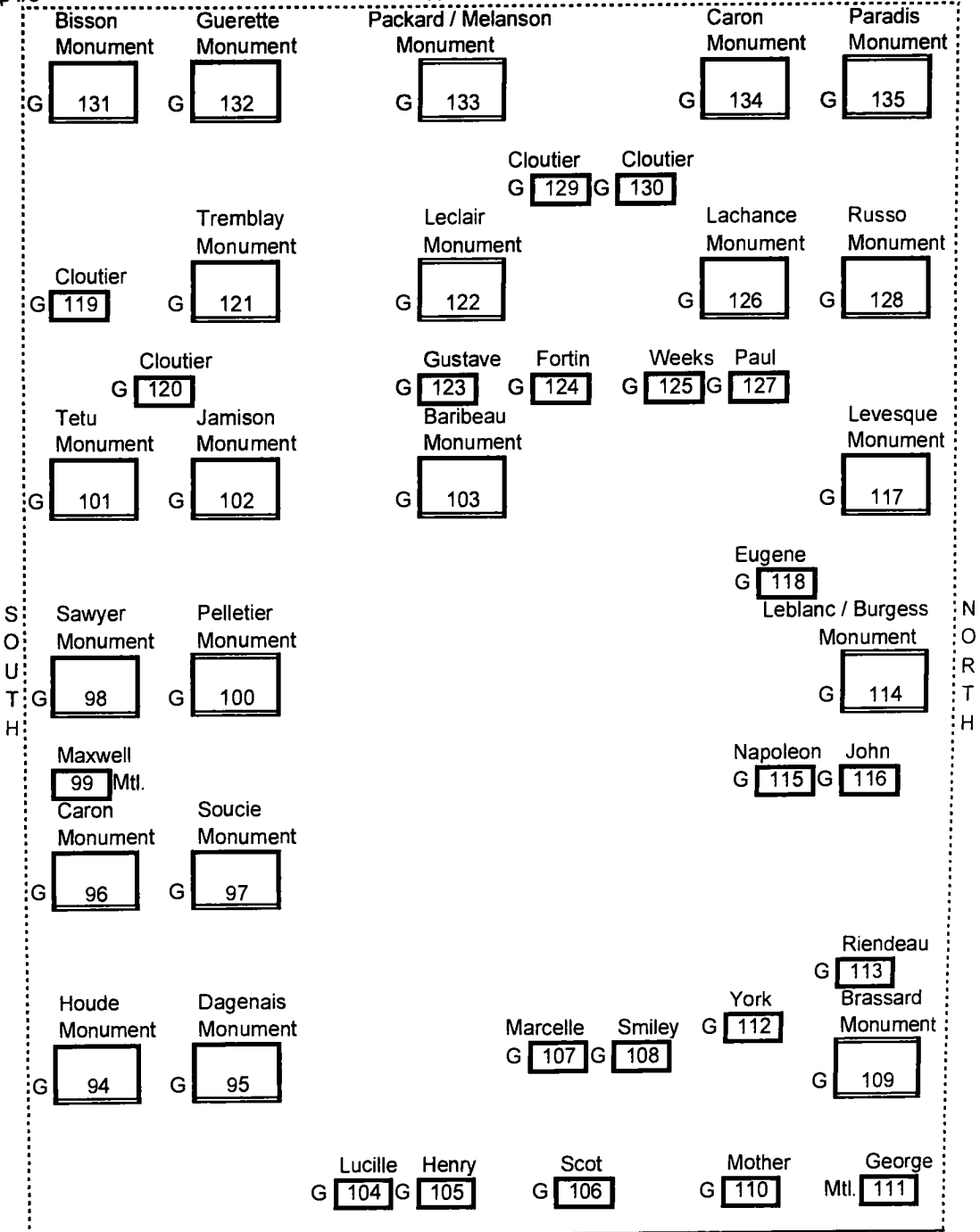

A C C E S S R O A D

E A S T

ST. JOHN THE BAPTIST CEMETERY - Range Layout

RANGE #1
Map #4

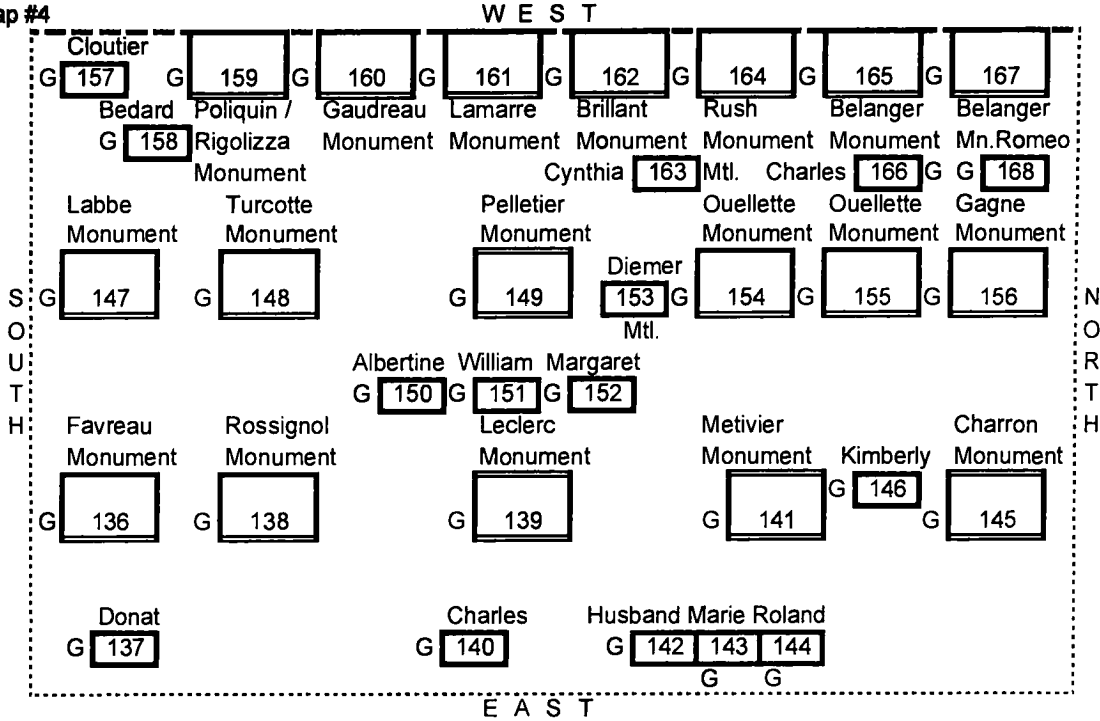

ST. JOHN THE BAPTIST CEMETERY - Range Layout

RANGE #1
Map #5

W E S T

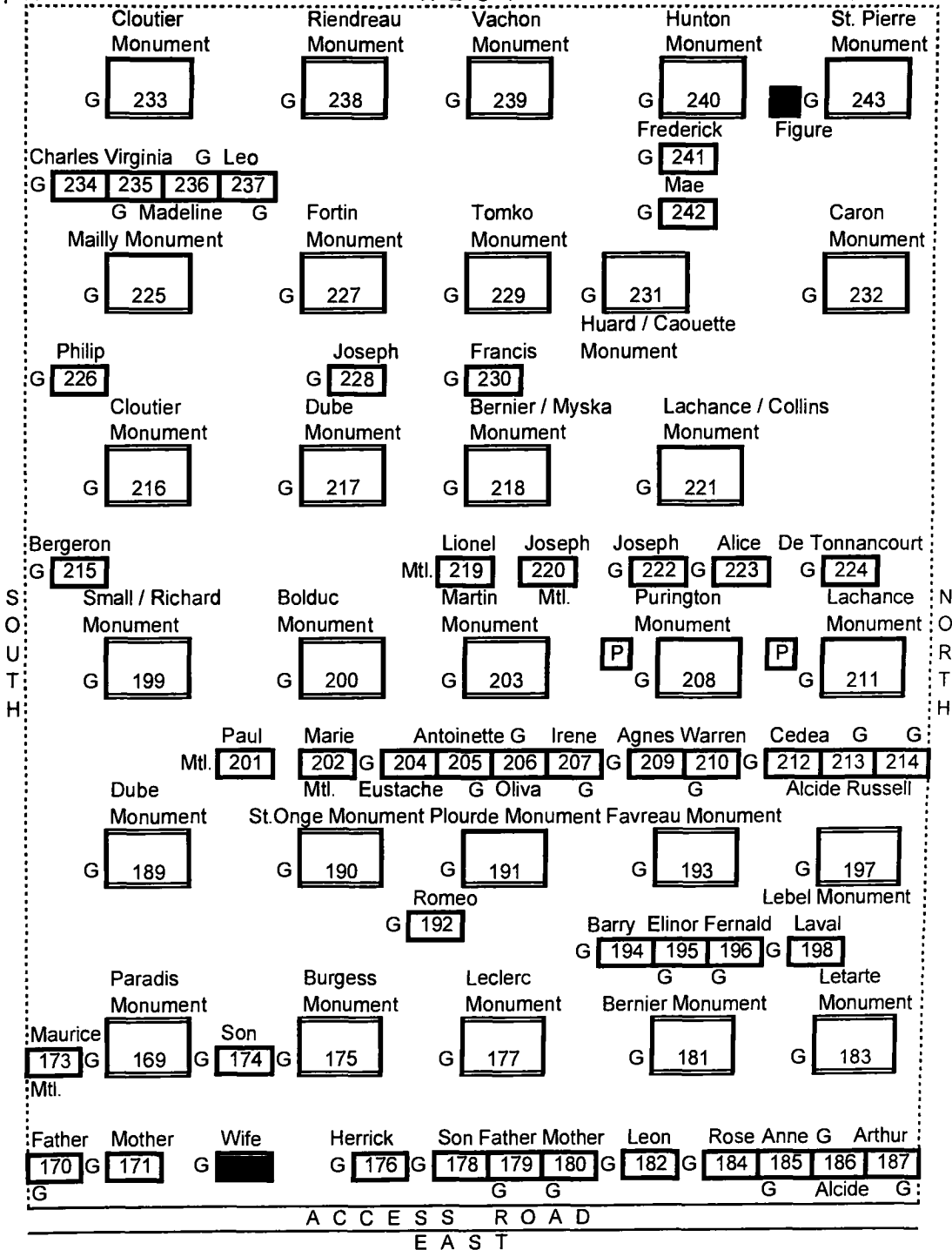

ST. JOHN THE BAPTIST CEMETERY - Range Layout

RANGE #1

Map #6

W E S T

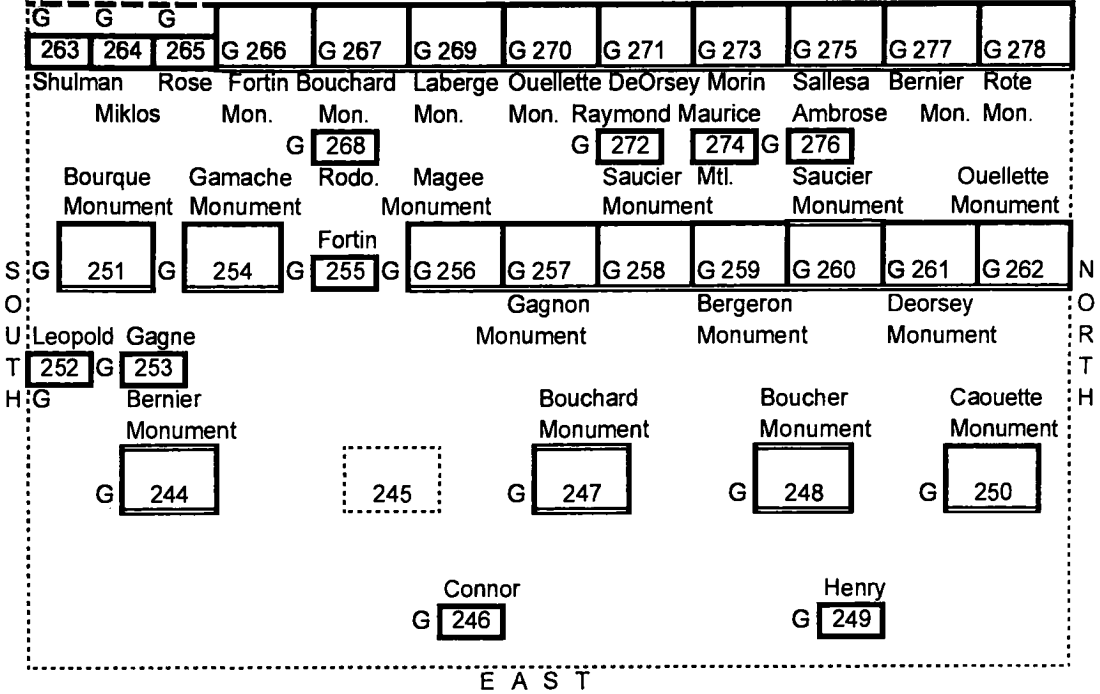

ST. JOHN THE BAPTIST CEMETERY - Range Layout

RANGE #1

Map #7

W E S T

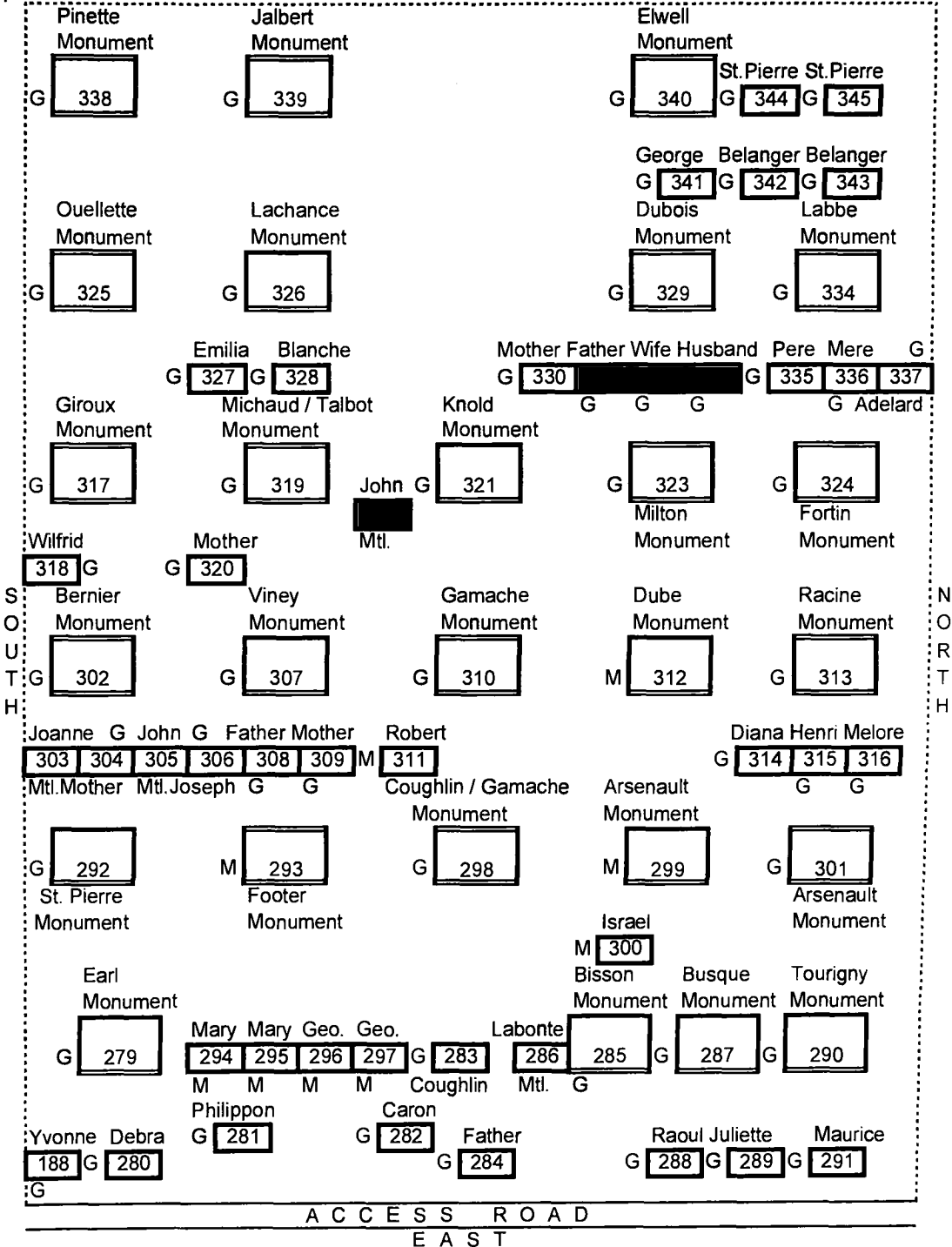

ST. JOHN THE BAPTIST CEMETERY - Range Layout

RANGE #1

Map #8

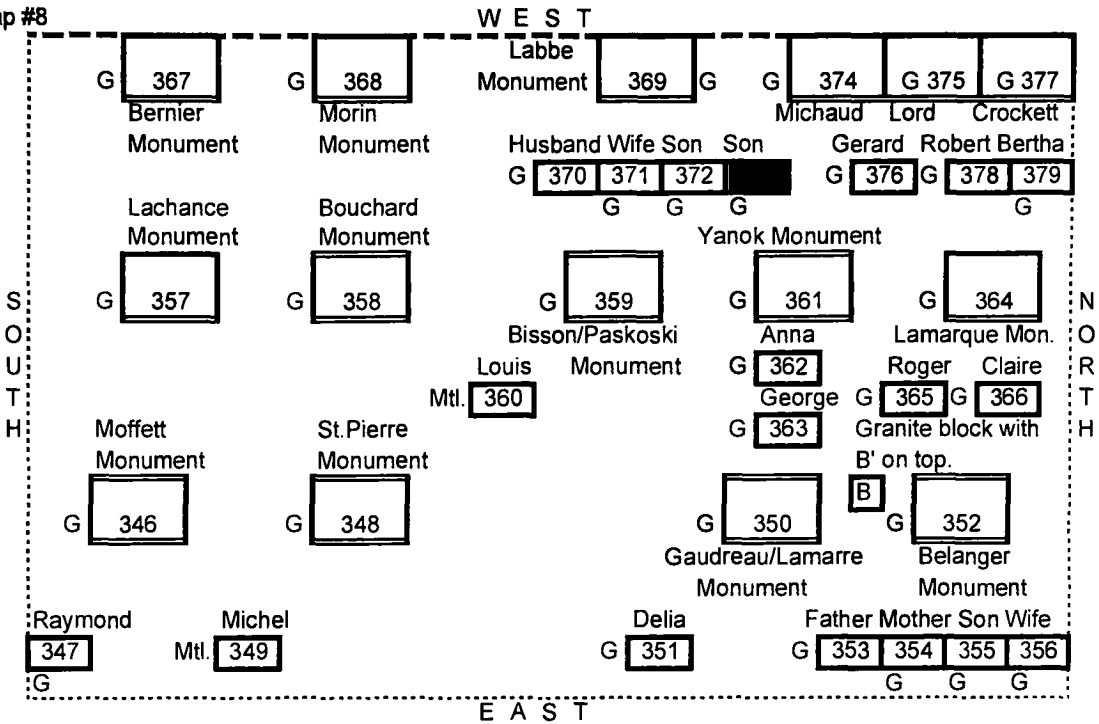

ST. JOHN THE BAPTIST CEMETERY - Range Layout

RANGE #1

Map #9

W E S T

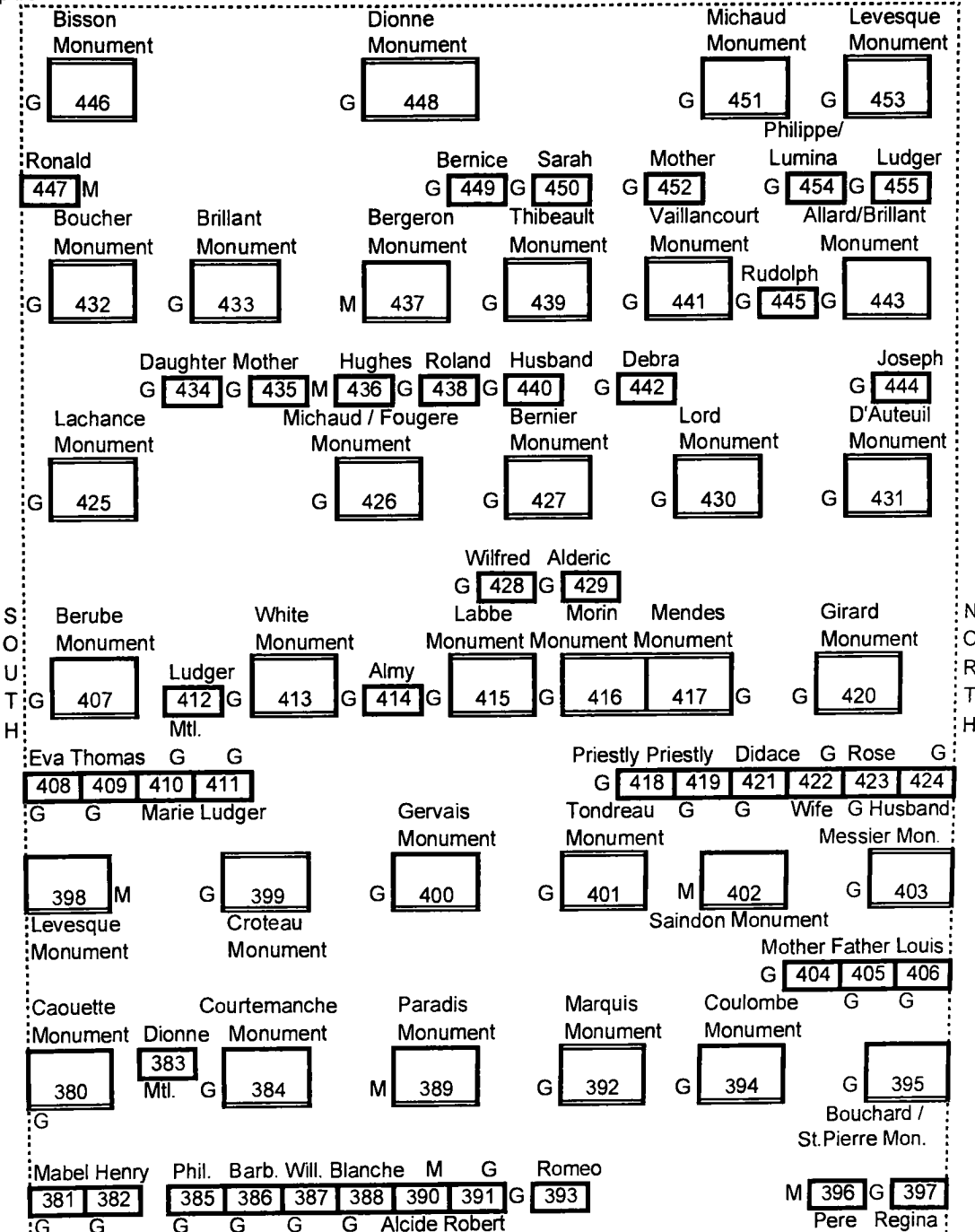

A C C E S S R O A D

E A S T

ST. JOHN THE BAPTIST CEMETERY - Range Layout

RANGE #1
Map #10

W E S T

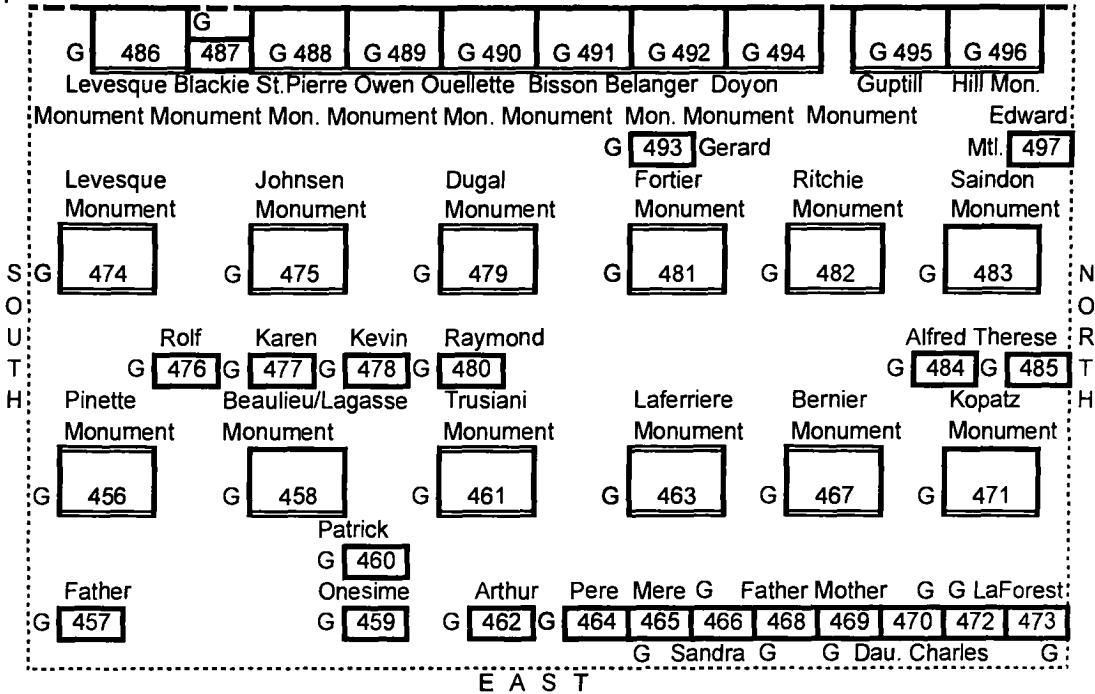

S O U T H

N O R T H

ST. JOHN THE BAPTIST CEMETERY - Range Layout

RANGE #1
Map #12

W E S T

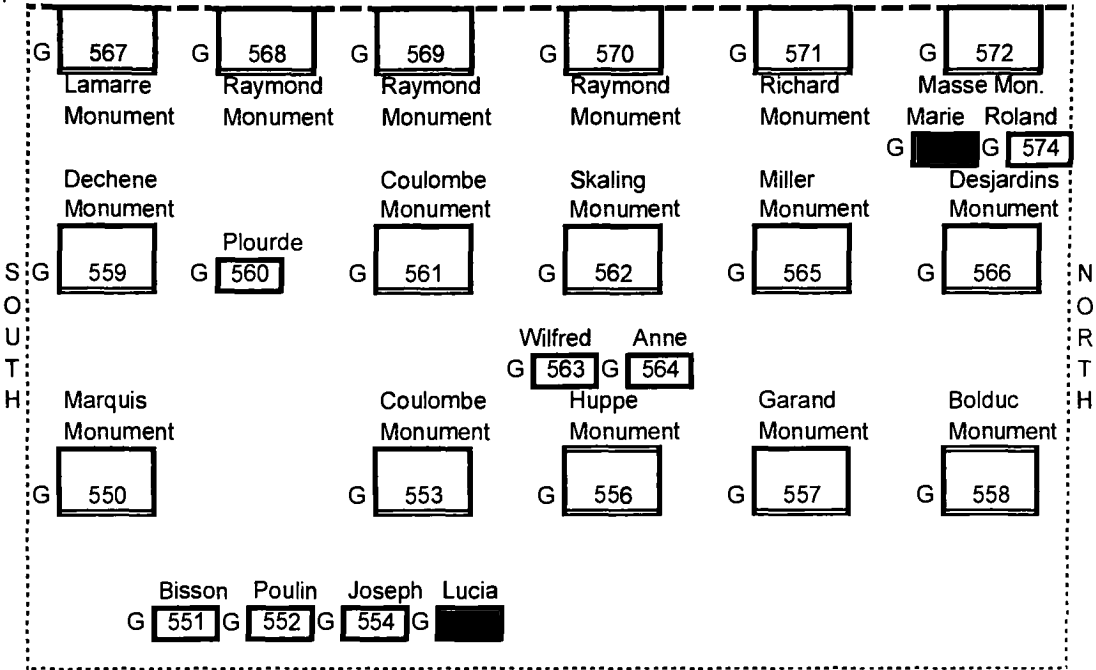

E A S T

ST. JOHN THE BAPTIST CEMETERY - Range Layout

RANGE #1

Map #13

W E S T

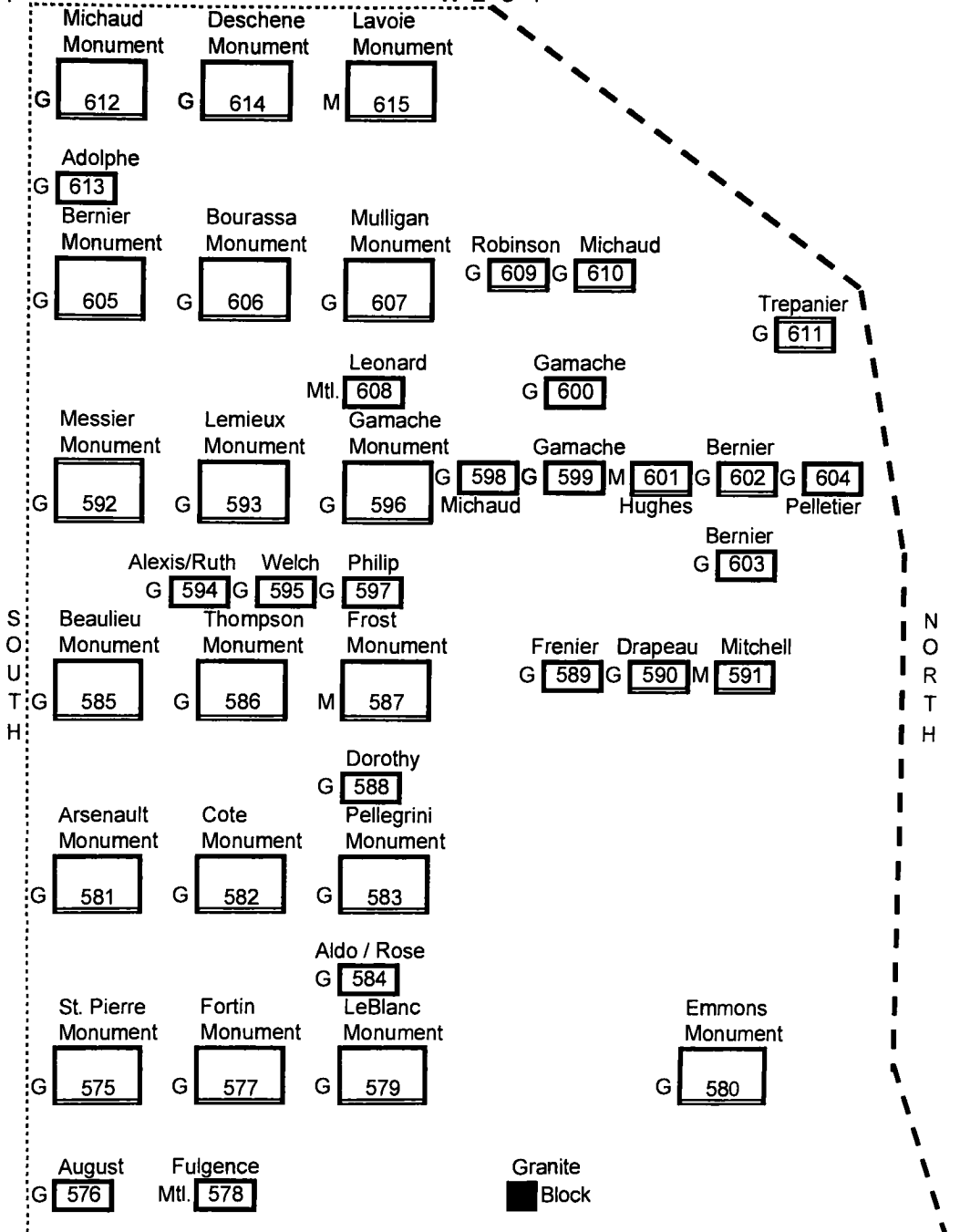

A C C E S S R O A D

E A S T

ST. JOHN THE BAPTIST CEMETERY - Range Layout

RANGE #1

Map #14

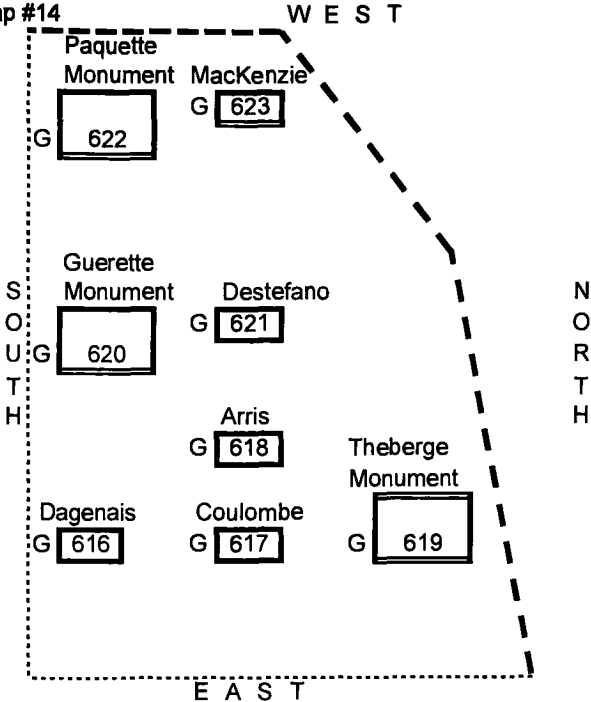

ST. JOHN THE BAPTIST CEMETERY
RANGE #1

(R1#1)	JAMES N. LAVIGNE 1880 - 1952	(R1#2)	CELISTINE LAVIGNE 1884 - 1982
--------	---------------------------------	--------	----------------------------------

(R1#3)	EDMOND FRADET 1902 1950	(R1#4)	PAUL FRADET 1902 1980
--------	----------------------------	--------	--------------------------

(R1#5)	JOHN J. LEVESQUE 1902 - 1953	(R1#6) Pelletier Monument PELLETIER LUCIEN MARIE LOUISE 1886 - 1953 1889 - 1984
--------	---------------------------------	--

(R1#7) Dufresce / Richard Monument
 East Face:

DUFRESNE
 RICHARD

(R1#8) V.F.W. Aux.
 ANNETTE F. SAUCIER
 1927 1952

West Face:

1892 ALDERIC RICHARD Jr. 1952
 1897 ALMA son epouse 1986
 1923 PAUL A. DUFRESNE 1994
 his wife
 1922 MURIEL C. RICHARD

(R1#10) Lavoie Monument
 East Face:

LAVOIE

(R1#9) CHARLOTTE M SAUNDERS
 Maine
 PFC Women's Army Corps
 World War II
 March 15 1903 May 28 1967

West Face:
 ALCIDE J. LAVOIE
 October 25, 1896
 January 2, 1952
 EDWINA E. LAVOIE
 June 27, 1900
 April 13, 1970

(R1#11) Journeault Monument
 JOURNEAULT

Husband	Wife
THOMAS Z. JOURNEAULT May 30, 1873 Jan. 6, 1954	BLANCHE L. MORIN June 20, 1877 June 23, 1970

(R1#12) Ward Monument
 1872 AMANDA ROSE WARD 1993
 daughter
 1903 CHARLOTTE M. SAUNDERS 1967

Marker: U.S. Veteran

(R1#13) Duquette Monument
 East Face:

DUQUETTE

West Face:

1905 WILFRED A. 1953
 1907 FERN O. his wife 1993

(R1#14) Lebel Monument
LEBEL
1898 EMILE J. A. LEBEL 1975
son epouse
1907 LILLIAN J. ST. ONGE 1958
1944 MARTIN J. LEBEL 1944

(R1#16) Moens Monument
MOENS
FRANCOIS MOE
1892 - 1963
son epouse
ALICE RICHAR
1898 - 1970
Jesus - Marie - Jo
Marker: U.S. Vet

(R1#15) Paquet Monument
PAQUET
ARTHUR DIANA
4 Dec. 1895 - 8 Fev. 1953 21 Nov. 1902 - 24 Mar. 1989
Jesus misericorde

(R1#17) ANNE M. BELANGER
June 19, 1921 May 4, 1997
wife of
JOSEPH P. L. BELANGER

(R1#18) JOSEPH P L BELANGER
PFC US Army
World War II
Apr 8 1919 Oct 20 1988

(R1#20) Bernier Monument
East Face:
BERNIER
West Face:
WILFRED M. BERNIER
16 Mars 1872 - 24 Mai 1957
son epouse
EZILDA GAMACHE
18 Oct. 1875 - 28 Mai 1963

(R1#19) Bernier Monument
BERNIER
1910 ARMAND W. 195
his wife
1914 ELFREDA E. 1970

(R1#21) Bailly Monument
BAILLY
Wife Husband
MARTHA E. PETER
Oct. 25, 1884 Nov. 14, 1882
July 8, 1954

Marker Stone:
(R1#22) Wife
MARTHA E. POOLER
Oct. 25, 1884
June 27, 1982

(R1#23) Mitchell Monument
East Face:
MITCHELL
West Face:
1882 DAVID T. 1954
his wife
1891 STELLA C. 1970

(R1#24) Bernier Monument
East Face:
BERNIER
Mon Jesus misericorde
West Face:
OVIDE F. BERNIER
24 Mars 1883 - 9 Aout 195
son epouse
MARIE A. BERNIER

(R1#25) Golden Monument
GOLDEN
Husband
JOHN W. GOLDEN
July 31, 1924 - Sept. 7, 1954

(R1#29) Bernier Monument

BERNIER
husband wife
LEANDER W. BERNIER CECILE FOR
July 11, 1904 - Nov. 28, 1954 Sept. 28, 1902
- My - Jesus - Mercy -

(R1#26) Saindon Monument
East Face:

SAINDON
Jesus misericorde

West Face:

ALPHONZO SAINDON
19 Mai 1882 - 28 Sept. 1954
son epouse
HILDEA LeBOURDAIS
25 Mai 1885 - 26 Fev. 1980

Marker: U.S. Veteran

Marker Stones:

(R1#27) PERE

(R1#28) MERE

(R1#30) Bernier Monument

East Face:

BERNIER
Mon Jesus misericorde

West Face:

LOUIS C. BERNIER
22 Mai 1912 - 15 Sept. 19
son epouse
GERMAINE DUVAL
22 Sept. 1907 - 4 Mars 19

Marker Stones:
(R1#31)

Epoux
LOUIS C. BERNI
22 Mai 1912
15 Sept. 1993

(R1#33) Doustou Monument

DOUSTOU
FRANCOIS MARIE
1888 - 1955 1868 - 1962

(R1#32)

Epouse
GERMAINE DUV
22 Sept. 1907
4 Mars 1955

(R1#34) Burgess Monument

East Face:

BURGESS
In God's care

Marker Stones:
(R1#35)

MONIQUE COULOMBE BURGE
Mar. 14, 1936 - Sept. 18, 1972

Marker: U.S. Veteran

(R1#36) JOHN C BURGESS J
US Army
Feb 25 1933 May 9 19

West Face:

1936 MONIQUE COULOMBE BURGESS 1972
her husband
1933 JOHN C. BURGESS Jr. 1999
his wife
1941 DOROTHY BOUCHARD BURGESS

(R1#37) Levesque Monument

East Face:

LEVESQUE
Jesus - misericorde

West Face:

CYPRIEN J. LEVESQUE
9 Mai 1882 - 28 Avril 1955
son epouse
EDWIDGE BILODAEU
11 Mai 1893 - 26 Dec. 1978

(R1#38) Paquette Monument

PAQUETTE

GAUDIAS MARIE RICHARD
1872 - 1962 son epouse
1876 - 1955

(R1#39) ERNEST J.
DIONNE Jr.
1888 - 1955

(R1#40) Lebel Monument

East Face:

LEBEL

West Face:

EDDIE A. LEBEL
13 Janv. 1895 - 13 Oct. 1955
son epouse
ODELIE GAMACHE LEBEL
10 Sept. 1895 - 24 Nov. 1997

(R1#41) Saucier Monument

East Face:

SAUCIER

"Que le saint nom du seigneur soit be
"Qu'ils reposent en paix"

West Face:

WILLIAM F. SAUCIER
15 Sept. 1884 - 19 Dec. 1955
son epouse
DELVINA PELLETIER
20 Sept. 1889 - 6 Avril 1967
buried Eagle Lake
son
HERBERT W. SAUCIER
30 Oct. 1915 - 21 Janv. 1990

(R1#42) Nadeau Monument

East Face:

NADEAU

West Face:

FLAVIEN J. NADEAU
1899 - 1955
YVONNE his wife
1899 - 1972

(R1#44) Michaud Monument

East Face:

MICHAUD

Coeur de Jesus soit notre salut

West Face:

ELISEE MICHAUD
13 Oct. 1878 - 21 Fev. 1956
son epouse
MEDDE LABBE
30 Juil. 1887 -

Marker Stone:

(R1#43) DENNIS G NADEAU
Cpl US Army
World War II
Oct 8 1926 Nov 15 1988

(R1#45) Richards Monument

East Face:

RICHARDS
Say a Hail Mary

West Face:

FLORIEN J. RICHARDS
Oct. 5, 1905 - July 24, 1956
his wife
MARIE A. COMTOIS

Marker Stones:

(R1#46) HUSBAND

(R1#47) WIFE

(R1#48) Deschenes Monument
DESCHENES
ROLAND
1917 -
son epouse
SIMONNE CARON
1918 - 1956
Jesus misericorde

Marker Stone:
(R1#49) ROLAND

(R1#50) Caron Monument
CARON
Husband Wife
AMABLE A. VIVIAN V.
1916 - 1915 - 2004

Marker Stone:
(R1#51) AMABLE A CARON
Sgt US Army
World War II
Feb 4 1916 Jun 1 2007

(R1#52) Bernier Monument
BERNIER
EMERILDA M. BERNIER
6 Sept. 1878 - 7 Avril 1956
Mon Jesus misericorde

(R1#53) Marquis Monument
MARQUIS
Wife Husband
MARGARET F. MARQUIS ERNEST J. MARQU
July 4, 1888 - Aug. 31, 1956 June 14, 1888 - Jan. 10.
Say a Hail Mary

(R1#56) Lebel Monument
LEBEL
EDDIE J. LOUISE B.
June 18, 1929 Nov. 20, 1931
April 1, 2007
In loving memory

Marker Stones:
(R1#54) WIFE
(R1#55) HUSBAN

Marker Stone:
(R1#57) EDDIE J LEBEL
Cpl US Army
Korea
1929 2007

(R1#58) Powers Monument
East Face:
POWERS
West Face:
WILLIAM H.
July 17, 1885 - Dec. 29, 1
ANNIE D. his wife
Feb. 14, 1889 - Jan. 4, 19

(R1#59) Charron Monument
CHARRON
WILLIAM J. CHARRON
Mar. 12, 1886 - Feb. 9, 1957
his wife
MARIE ANN ST. ONGE
Nov. 13, 1887 - July 27, 1971
Say a Hail Mary

(R1#60) Roy Monument
NAPOLEON C. VIOLETTE
1914 - 1957 1919 - 1957
ROY

Marker Stone:
(R1#61) NAPOLEON C. ROY

(R1#62) Charron Monument

East Face:

CHARRON
In God's care

West Face:

1892 CHARLES J. CHARRON 1982
his wife
1893 EVA M. GAMACHE 1969

(R1#63) Lebel Monument

Hail Mary, pray for us:

LEBEL

ERNEST A. LEBEL

Jan. 17, 1888 - Nov. 29,

his wife

BLANCHE GALARNEAU

Apr. 27, 1888 - Aug. 17,

(R1#64) Galarneau Monument

East Face:

GALARNEAU

Marker: U.S. Veteran

West Face:

CONRAD GALARNEAU
June 3, 1895 - Nov. 28, 1958
his daughter
CARMELLE BAILEY
July 18, 1923 - Oct. 10, 1977

Marker Stones:

(R1#65)

CONRAD GALARNEAU

Maine

Pvt US Army

World War I

June 3 1895 Nov 28 1958

(R1#66)

DEAR
COUSIN

(R1#67) Bernier Monument

BERNIER

1892 SIMEON BERNIER 1968
son epouse

1897 MARIE ANNA BERNIER 1958
Dites un "je vous salue, Marie"

(R1#68) Doyon Monument

East Face:

DOYON

Dites un "je vous salue, Marie"

West Face:

1879 ARTHUR J. DOYON 1918
son epouse

1886 EMMA M. FOURNIER 1918

(R1#69) Bossie Monument

BOSSIE

WALLACE DE LOURDE
1907 - 1958 1913 - 1996

(R1#70) Dube Monument

DUBE

Epoux : Epouse
ERNEST J. DUBE : ROSE A. LECLEF

16 Juil 1882 : 16 Mai 1887

15 Aout 1958 : 11 Janv 1973

Dites un je vous salue, Marie

(R1#71) Courmier Monument

CORMIER

VALMORE

died June 3, 1958

Marker Stone:

(R1#72)

HERMANCE R. CORMIER

wife of

VALMORE CORMIER

Jan. 11, 1902 - Feb. 20, 1988

(R1#73) Lebel Monument

East Face:

Je vous salue Marie
LEBEL

West Face:

ERNEST LEBEL
7 Nov. 1897 -
son epouse
ANNA RUEST LEBEL
1 Dec. 1895 - 22 Fev. 1958

(R1#74) Blanchette Monument

East Face:

Jesus, priez pour nous BLANCHETTI

Marker: U.S. Veteran

West Face:

ARTHUR A. BLANCHETTE
28 Mars 1897 - 20 Fev. 1958
son epouse
DELIA VOISINE
23 Mars 1904 - 8 Juil. 1967

(R1#75) St. Onge Monument

ST. ONGE
THELESPHORE E. ST. ONGE
Apr. 12, 1891 - May 31, 1977
his wife
ANNIE G. BERNIER
Jan. 20, 1892 - Aug. 29, 1965
Say a "Hail Mary"

Marker Stone:

(R1#76) TELESPHORE E. ST. O
PFC US Army
World War I
1891 1977

(R1#77) Carlson Monument

East Face:

CARLSON
Say a hail Mary

West Face:

ANTONIO CARLSON
Jan. 17, 1891 - June 16, 1959
his wife
YVONNE LABBE CARLSON
Mar. 28, 1904 - Jan. 23, 1979

Marker Stone:

(R1#78) ANTONIO

(R1#79) Labbe Monument

LABBE
Notre pere qui etes aux cieux
Que votre nom soit sanctifie
LUDGER P. ORDINA M.
1904 - 1959 1903 - 1994

(R1#80) Dugal Monument

DUGAL
EUGENIE FOURNIE
June 29, 1888 - Feb. 23, 1
her son
JEROME J. DUGAL
July 11, 1914 - Aug. 5, 1
"Please say a Hail Mar

Marker: U.S. Veteran

Marker Stone:

(R1#81)

JEROME J DUGAL
Maine
PFC Army Air Forces
World War II
July 11 1914 Aug 5 1959

(R1#82) Gaudreau Monument

GAUDREAU
NARCISSE GRAZIEL
GAUDREAU GROND
17 Janv. 1898 26 Juil. 1
26 Mars 1972 17 Aout
Dites nous un "Je vous salue, M

(R1#83) Wilson Monument

WILSON
Father Mother
1895 ANDREW J. 1959 1895 IRMA R. 1967

(R1#84) Renaud Monument

RENAUD
TELESPHORE RENAUD
1881 - 1967
son epouse
ALICE CARON
1888 - 1959
Mon Jesus misericorde

(R1#85) Gaudreau Monument

East Face:
GAUDREAU
In loving memory
West Face:
JOHN B. GAUDREAU
Oct. 3, 1903 - May 10, 1
his wife
EVA A. LEBEL
Feb. 2, 1907 - Oct. 25, 1

(R1#86)

TODD J. THIBOUTOT
May 11, Feb. 18,
1970 1998
Forever in our hearts

(R1#87)

J. ROLAND
MORIN
1927 -

(R1#88)

DORINA C.
MORIN
1925 -

(R1#89)

LABONTE
PHILLIPPE J. EMILIEN
Oct. 24, 1923 Togetherness Nov. 19, 1

(R1#90) Bernier Monument

BERNIER
CONRAD J. Sept. 1, 1936 ANNETTE L.
1910 - 1993 1902 - 1993
What we remember is never lost.
We will remember always their deep faith,
indomitable spirit in adversity, generosity
and love of family, friends and each other.

Marker: Army WWII
Korea Vietnam

(R1#91)

FLORENCE L. SKOLFIE
September 8, 1913
November 14, 1996

(Date in center with two interlocking rings
across it.)

(R1#92) DUNCAN
THOMAS L.
Jan. 31, 1916 - Jan. 12, 1998
his wife
ALMA M. RICHARDS
June 4, 1914 - June 16, 1993

(R1#93) HACHEY
JANETTE T. PATR
1920 - 1993 1913 -
In God's care

(R1#94) Houde Monument
HOUDE
1906 ARMAND I. 1967
1912 MARIE R. 2000
In God's care

(R1#95) Dagenais Monument
DAGENAIS
1904 "BABE" ELZEAR 1983
his wife
1903 FLORIDA 1967

(R1#96) Caron Monument
CARON
1884 LEON CARON 1967
son epouse
1886 MARIE LOUISE GAMACHE 1969
Jesus Marie Joseph

(R1#97) Soucie Monument
SOUCIE
1909 DELSIE E. SOUCIE
his wife
1913 CATHERINE R. GOLDEN
My Jesus mercy

(R1#98) Sawyer Monument
SAWYER
MAXWELL D. MARY E.
1898 - 1967 1900 - 1994

Marker Stone:
(R1#99) MAXWELL D SAWYER
Maine
S2 USNRF
World War I
Sept 29 1898 March 14 1994

Marker: U.S. Veteran

(R1#100) Pelletier Monument
West Face:

PELLETIER
East Face:
Father
EMILE A. PELLETIER 1890 - 1967
Mother
M. ANNE
1888 - 1967

(1#101) Tetu Monument
TETU
LUDGER TETU
1890 - 1966
son epouse
ILDEA MESSIER
1893 - 1976
Jesus Marie Joseph

(R1#102) Jamison Monument

IHS
JAMISON
1909 DONALD JAMISON 1966
his wife
1909 ALBERTEAN M. BELANGER 1992

(R1#103) Baribeau Monument

BARIBEAU

Marker Stones:

(R1#104)	LUCILLE A. BARIBEAU May 5, 1908 - Dec. 28, 1961	(R1#105)	HENRY M. BARIBEAU Oct. 8, 1905 - Mar. 21, 1988
(R1#106)	SCOT D. BARIBEAU Feb. 23, 1957 Dec. 9, 1960	(R1#107)	MARCELLE BARIBEAU SMILEY March 9, 1927 May 17, 1995
(R1#108)	RUSSELL E SMILEY US Air Force WWII Korea Vietnam Apr 8 1922 Aug 11 1977	Marker: U.S. Veteran	

(R1#109) Brassard Monument

East Face:

Mother
BRASSARD

Marker Stones:

(R1#110) MOTHER

West Face:

ALICE M. FOUGERE
Apr. 19, 1904 - July 30, 1960
GEORGE E. BRASSARD
Nov. 14, 1930 - Nov. 2, 2004

(R1#111) GEORGE EDWARD BRASSARD
MGYSGT US Marine Corps
Korea Vietnam
Nov 14 1930 Nov 2 2004

(R1#112)

Our Infant Son
EDWARD
son of
DAVID and JACKIE YORK
Feb. 10, 1962

(R1#113)

EDWARD J RIENDEAU
PFC US Army
World War II
Oct 23 1920 Mar 16 1983

(R1#114) Leblanc / Burgess Monument

East Face:

LEBLANC - BURGESS
My Jesus mercy

Marker Stones:

(R1#115) NAPOLEON LEBLANC
Aug. 18, 1884 - Apr. 9, 1963
his wife
REGINA BRILLANT
Nov. 9, 1888 - Oct. 28, 1978

West Face:

1884 NAPOLEON LEBLANC 1963
his wife
1888 REGINA BRILLANT 1978
their daughter
1909 YVONNE LEBLANC 2004
her husband
1905 JOHN C. BURGESS 1987

(R1#116)

JOHN C. BURGESS Sr.
July 17, 1905 - Nov. 8, 1987
his wife
YVONNE LEBLANC
Aug. 20, 1909 - Oct. 8, 2004

(R1#117) Levesque Monument

EUGENE E. RITA E.
1895 - 1964 LEVESQUE 1923 - 1990
1902 IDA E. 1991
Jesus Marie Joseph

Marker: U.S. Veteran

Marker Stone:
(R1#118)

EUGENE E LEVESQUE
Maine
PFC Co A 101 Engineers
World War I
Dec 29 1895 Jan 25 1964

(R1#119) RAYMOND O CLOUTIER
PFC US Army
World War II
Apr 8 1909 May 20 2001

Marker: U.S. Veteran

(R1#120) ULRIC CLOUTIER
BM2 US Navy
World War II
Sep 2 1907 Oct 28 1987

(R1#122) Leclair Monument
East Face:

LECLAIR
Jesus Mary Joseph

(R1#121) Tremblay Monument
TREMBLAY
JEAN B. MARIA
1894 - 1966 1892 - 1972
Jesus Marie Joseph

Marker: U.S. Veteran

West Face:
1915 GUSTAVE O. LECLAIR 20
his wife
1923 ALMA R. MERCIER 19
1913 EMILY LABONTE 19

Marker: U.S. Veteran

(R1#124) LUCIANNA L. FORTIN
1918 - 1972

Marker Stone:
(R1#123) GUSTAVE O LECLAIR
Sgt US Army
World War II
Feb 12 1915 Oct 13 2001

(R1#125) IDA L. WEEKS
wife of GERALD G. WEEKS
1918 - 1983

(R1#126) Lachance Monument

LACHANCE
ALPHONSE J. LEDA M.
1883 - 1966 1885 - 1970
1915 PAUL E. LACHANCE 1973

Marker: U.S. Veteran

Marker Stone:
(R1#127)

PAUL E LACHANCE
Maine
PFC US Army
World War II
Jan 14 1915 Oct 2 1973

(R1#128) Russo Monument
RUSSO

JAMES V. ROSANNA J.
1896 1893 his wife

(R1#129) MARY CLOUTIER
1912 - 1970

We remember your generosity

(R1#130) LIONEL A. CLOUTIER
1910 - 1967

(R1#131) Bisson Monument
BISSON
NAPOLEON CECILE
1899 - 1982 1901 - 197

(R1#132) Guerette Monument
GUERETTE
1882 JOSEPH D.
his wife
1888 JOSEPHINE M. 1966

(R1#133) Packard / Melonson Monument
East Face:

PACKARD
MELONSON
DONALD H. DOROTHY L.
1905 - 1973 1912 - 1967

(R1#134) Caron Monument
CARON
JEAN C. GRACE A. DOROTHY G.
1932 - 1912 - 2000 1934 - 2003

West Face:
1901 EDNA L. MELONSON 19
1933 PATRICIA A. PACKARD 20

(R1#135) Paradis Monument
East Face:
PARADIS
Jesus Mary Joseph
West Face:
ALBERT J. PARADIS
Feb. 27, 1899 - Dec. 31, 1968
his wife
YVONNE LEBEL
July 27, 1905 - July 25, 1967
RICHARD J.
Aug. 14, 1937 - July 1, 1971

(R1#136) Favreau Monument
FAVREAU
1894 DONAT A. FAVREAU 19
son epouse
1894 LUCIENNE MATHIEU 19
Jesus Marie Joseph
Marker: U.S. Veteran

Marker Stone:
(R1#137) DONAT A FAVREAU
Maine
Pvt Co M 74 Infantry
World War I
April 19 1894 Nov 7 1906

(R1#138) Rossignal Monument
ROSSIGNOL
1906 ALDERIC J. 1966
his wife
1912 CECILE M. 1997
Jesus Mary Joseph

(R1#139) Leclerc Monument
East Face:

LECLERC

Marker: U.S. Veteran

West Face:
1914 CHARLES E. LECLERC 199
1915 GRACIA P. BOIS, wife 199
their son
1947 DAVID L. LECLERC
1948 PATRICIA ANN VIEL, wife
their son
JONATHAN JAY LECLERC

(R1#141) Metivier Monument

East Face:

METIVIER
1898 NAPOLEON METIVIER 1973
his wife
1899 MARIE D. VACHON 1979
In loving memory

Marker: U.S. Veteran

West Face:

Son
ROLAND L. METIVIER
Dec. 23, 1920 - Mar. 4, 1984

Marker Stones:

(R1#142) Husband
NAPOLEON METIVIER
1898 - 1973

(R1#143) MARIE D. VACHON
1899 - 1979

(R1#144) ROLAND L METIVIER
Pvt US Army
World War II
Dec 23 1920 Mar 4 1984

(R1#148) Turcotte Monument

TURCOTTE
1899 JOSEPH L. TURCOTTE 1984
his wife
1900 HELENA E. FORTIN 1987
In loving memory

(R1#149) Pelletier Monument

East Face:

PELLETIER
Say a Hail Mary

Marker Stone:

(R1#140) CHARLES E LECLERC
PFC US Army
GM2 US Navy
World War II
Feb 14 1914 Mar 4 1995

(R1#145) Charron Monument

East Face:

CHARRON

West Face:

1901 VARNEY J. CHARRON 19
his wife
1908 YVETTE H. BELANGER 19

Marker Stone:

(R1#146) Our beloved daughter
KIMBERLY Y. CHARRON SAWY
March 22, 1980
October 9, 2005

(R1#147) Labbe Monument

LABBE
LAUDIA Jesus AUGUST
1892 - 1968 Marie 1890 - 19
Joseph

West Face:

WILLIAM PELLETIER
May 23, 1908 - Aug. 19, 1990
his wife
ALBERTINE BOUCHARD
Mar. 27, 1908 - June 7, 1959
MARGARET B. PELLETIER
Jan. 31, 1915 - Oct. 6, 1988

Marker Stones:

(R1#150) ALBERTINE BOUCHARD
1908 - 1959
wife of
WILLIAM PELLETIER

(R1#151) WILLIAM PELLETIER
1908 - 1990

(R1#152) MARGARET NICKERSON
1915 - 1988
wife of
WILLIAM PELLETIER

(R1#153) REBECCA M. DIEMER
1955 - 1955

(R1#154) Ouellette Monument
OUELLETTE
1933 BETTY M. RUSH 1967
In God's care

(R1#155) Ouellette Monument
OUELLETTE
Husband Wife
VITAL J. OUELLETTE ANNA EMOND
Sept. 9, 1897 Oct. 12, 1897
May 6, 1970 June 26, 1988

(R1#156) Gagne Monument
GAGNE
LUDGER "Doc" : EUGENIE M.
1904 - 1967 : 1905 - 1978

(R1#157) DEBRA A.
CLOUTIER
1961 - 1992
In our hearts

(R1#158) BERNARD A BEDARD
US Army
Oct 27 1937 Sep 28 1991
Marker: U.S. Veteran

(R1#159) Poliquin / Rigolizzo Monument
POLIQUIN
ORIGENE C. FERNANDE E.
1916 - 2002 1919 -
RIGOLIZZO
BRIAN THERESE A.
1959 - 1955 -

(R1#160) Gaudreau Monument
GAUDREAU
SIMONE BISSON
April 19, 1922
July 13, 1996

(R1#161) Lamarre Monument
LAMARRE
JOHN P. RACHEL A.
1932 - 1987 1932 -

(R1#162) Brillant Monument
BRILLANT
ROLAND L. CYNTHIA J.
May 14, 1935 Feb. 19, 1939
June 13, 2007

(R1#164) Rush Monument
RUSH
ROLAND M. Jr. SONIA A. RICHARDS
Nov. 9, 1935 Oct. 3, 1936
Apr. 2, 1986
Married Jan. 5, 1957

Marker Stone:
(R1#163) CYNTHIA J BRILLANT
1939 2007

(R1#177) Leclerc Monument

East Face:

LECLERC

West Face:

RAYMOND ERNEST LECLERC

Sept. 1, 1915 May 10, 1984

his wife

ALFREDA ANNE MARIE BOURQUE

May 14, 1917 June 21, 1984

their son

RAYMOND ERNEST LECLERC, Jr.

Dec. 4, 1938 Oct. 11, 1980

Marker Stones:

(R1#178)

Son
RAYMOND

(R1#179)

Father
RAYMOND

(R1#180)

Mother
ALFRED

(R1#181) Bernier Monument

East Face:

BERNIER

West Face:

LEON C. BERNIER

Dec. 23, 1922 - Feb. 7, 1978

his wife

ROSE ALICE LETARTE

July 16, 1921 -

ROLAND L. BERNIER

Apr. 7, 1948 - Dec. 17, 1995

Marker Stone:

(R1#182)

LEON C BERNIER
S Sgt US Army
World War II
Dec 23 1922 Feb 7 1978

Marker: U.S. Veteran

(R1#183) Letarte Monument

East Face:

LETARTE

West Face:

ALCIDE J. LETARTE

July 12, 1892 - Mar. 24, 1986

his wife

ALINE CARON

Jan. 24, 1891 - Mar. 4, 1962

JEAN PIERRE LETARTE

Jan. 27, 1925 -

his wife

YVONNE V. ANCTIL

May 5, 1926 - Mar. 11, 2001

ARTHUR "Chip" DUBOIS Jr.

Sept. 8, 1977 - Feb. 16, 1987

Marker Stones:

(R1#184)

ROSE ALICE LETARTE
wife of LEON C. BERNIER
July 16, 1921 -

(R1#185)

ALINE CARON
wife of ALCIDE J. LETARTE
Jan. 24, 1891 Mar. 4, 1962

(R1#186)

ALCIDE J LETARTE
US Army
World War I
Jul 12 1892 Mar 24 1986

(R1#187)

ARTHUR "Chip" DUBOIS
son of ARTHUR and
BRIDGET LETARTE DUBOIS
Sept. 8, 1977 - Feb. 16, 1987

Marker: U.S. Veteran

(R1#197) Lebel Monument

East Face:

LEBEL

Marker Stone:

(R1#198)

LAVAL R LEBEL

Maine

AS US Navy

World War II

Dec 2 1907 May 22 1973

West Face:

LAVAL R. LEBEL

1907 - 1973

son epouse

VIVIANE G. LACHANCE

1923 - 1997

(R1#199) Small / Richard Monument

East Face:

SMALL - RICHARD

Thank you for the little things that made many moments special
and the love that made my lifetime happy. See you in paradise.

West Face:

BABY SMALL

May 2, 1950

Mar. 26, 1930

LORETTE M. SMALL

Oct. 5, 2006

sons

Apr. 22, 1952

RICHARD F. SMALL

May 25, 1957

GARY A. SMALL

Mar. 8, 2000

Nov. 4, 1900

ALFRED C. RICHARD

Feb. 5, 1996

his wife

Jan. 23, 1904

FLORIDA M. DESROSIER

Sept. 10, 1995

(R1#200) Bolduc Monument

East Face:

BOLDUC

Mon Jesus misericorde

Marker Stones:

(R1#201)

PAUL BOLDUC

Maine

Pvt Co K 26 Infantry

World War I

March 1 1888 Dec 18 1971

West Face:

1888 PAUL BOLDUC 1971

son epouse

1898 MARIE V. BOLDUC 1997

(R1#202)

MARIE V BOLDUC

Nov 29 1898 Aug 5 1997

wife of

PAUL BOLDUC

Marker: U.S. Veteran

(R1#203) Martin Monument

East Face:

IHS
MARTIN
Jesus Marie Joseph

Marker: U.S. Veteran

Marker Stones:

(R1#204) EUSTACHE MARTIN
Maine
Cpl Quarter Master Corps
World War I
Feb 28 1896 March 27 1964

(R1#207) IRENE

(R1#208) Purington Monument

PURINGTON

F				M
A	WARREN A.		AGNES T.	O
T	June 25, 1900	Married Nov. 29, 1923	Feb. 24, 1896	T
H	June 10, 1971		Apr. 12, 1962	H
E				E
R				R

Marker Stones:

(R1#209) AGNES (R1#210) WARREN

(R1#211) Lachance Monument

LACHANCE

wife	husband
CEDEA LACHANCE	ALCIDÉ LACHANCE
Dec. 18, 1896 - Feb. 9, 1962	Oct. 28, 1892 - Feb. 1, 1968
My Jesus mercy	

Marker: U.S. Veteran

Marker Stones:

(R1#212)	CEDEA LACHANCE	(R1#213)	ALCIDÉ LACHANCE
	Dec. 18, 1896 Feb. 9, 1962		Maine
	wife of		Pvt 9 Co 151 Depot Brig
	ALCIDÉ LACHANCE		World War I
			Oct 28 1892 Feb 1 1968

West Face:

OVILA	IHS	EUSTACHE
MARTIN		MARTIN
1906 - 1964		1896 - 1964
epouse		epouse
IRENE		ANTOINETTE
HELIE		FAVREAU
1909 - 1996		1890 - 1980

(R1#205) ANTOINETTE FAVREAU
epouse de
EUSTACHE MARTIN

(R1#206) OVILA

(Marker Stones Cont'd.)

(R1#214) RUSSELL G LACHANCE
TEC 5 US Army
World War II
Dec 26 1926 Feb 10 1994

(R1#215) GERARD O BERGERON
Tec 5 US Army
Nov 25 1924 Jan 12 2000

(R1#216) Cloutier Monument

East Face:

CLOUTIER
JOSEPH E. CLOUTIER
1890 - 1963
his wife
BLANCHE V. EARL
1893 - 1971
Jesus Mary Joseph

West Face:

Son
JOSEPH W. CLOUTIER

GERARD O. BERGERON Jr.
1924 - 2005
his wife
GERTRUDE J. CLOUTIER
1924

Marker: U.S. Veteran

(R1#221) Lachance / Collins Monument

LACHANCE - COLLINS
1896 ADELARD 1967 1922 RUSSELL R.
his wife his wife
1901 ALICE 1974 1922 CONSTANCE M.
Jesus Mary Joseph

Marker: U.S. Veteran

Marker Stones:

(R1#222) JOSEPH A LACHANCE
Maine
PFC Debarkation Hosp 1
World War II
July 22 1896 March 8 1967

(R1#223) ALICE LACHANCE
May 19, 1901 - Feb. 9, 1974

(R1#217) Dube Monument

East Face:

DUBE
Thy will be done

West Face:

1903 WILFRED ABEL DUBE 19
his wife
1907 MARY ANNA HUDAK 19
son
1925 LUCIEN R. DUBE
his wife
1923 JEANNE LAVALLEE 19

(R1#218) Bernier / Myska Monument

East Face:

BERNIER MYSKA

West Face:

LIONEL R. BERNIER
July 23, 1913 May 15, 19
JOSEPH MYSKA
Mar. 19, 1924 June 18, 19
GEORGETTE T. his wife
Jan. 11, 1924 Jan. 5, 2000

Marker: U.S. Veteran

Marker Stones:

(R1#219) LIONEL R BERNIER
PFC US Army
World War II
Jul 23 1913 May 15 1974

(R1#220) JOSEPH MYSKA
US Army
Mar 19 1924 Jun 18 1994

(R1#225) Maily Monument
IHS
MAILLY
Husband Wife
PHILIP C. THERESE R.
1930 - 1964 1929 - 2006
Angels of God guard us

Marker: U.S. Veteran

(R1#224) KURT A. DeTONNANCOURT
May 4, 1957 July 15, 1963
'Tiger'

Marker Stone:
(R1#226) PHILIP C MAILLY
Maine
PFC US Marine Corps
Korea PH
Dec 12 1930 Nov 24 1963

(R1#227) Fortin Monument
East Face:
FORTIN
Jesus Mary Joseph
West Face:
1889 JOSEPH F. FORTIN Sr. 1964
his wife
1895 ROSE B. FOURNIER FORTIN
their son
1921 JOSEPH F. FORTIN Jr.
his wife
1930 GERALDINE L. GEROW

Marker: U.S. Veteran

Marker Stone:
(R1#228) JOSEPH FRANK FORTIN
Maine
US Marine Corps
World War II
April 1 1921 Aug 18 1970

(R1#229) Tomko Monument
East Face:
TOMKO
God gives us love, something to love he lends us.
West Face:
1926 FRANCIS J. TOMKO 1968
his wife
1927 THERESA Y. ST.PIERRE
their son
1948 STEPHEN F. TOMKO 1964

Marker: U.S. Veteran

Marker Stone:
(R1#230) FRANCIS J TOMKO
Maine
AMM 3 US Navy
World War II
Jan 21 1926 June 5 1968

(R1#231) Huard / Caouette Monument
East Face:
HUARD
CAOUCETTE
Jesus Marie Joseph

West Face:
1906 FRANCOIS HUARD 1983
son epouse
1916 FLORENCE CAOUCETTE 1996
1892 NAPOLEON CAOUCETTE 1975
son epouse

(R1#233) Cloutier Monument
 CLOUTIER
 1910 CHARLES A. CLOUTIER 1992
 his wife
 1905 VIRGINIA E. FITZ 1967
 1909 LEO J. CLOUTIER 2000
 his wife
 1907 MADELINE M. FITZ 1998

Marker Stones:

(R1#234) CHARLES
 In God's loving care

(R1#235) VIRGINIA
 In God's loving care

(R1#237) LEO
 In God's loving care

(R1#232) Caron Monument
 East Face:
 CARON
 West Face:
 1905 ALBERT D. CARON 19
 his wife
 1904 JEANNE LEBOURDAIS 20
 son
 1934 ALBERT C. CARON 19
 his wife
 1933 LUCILLE PINETTE

(R1#236) MADELINE
 In God's loving care

(R1#238) Riendeau Monument
 East Face:
 RIENDEAU
 Jesus Marie Joseph
 West Face:
 1906 RONALDO J. RIENDEAU 1967
 son epouse
 1901 EMILIA BOURGAULT 1992

(R1#239) Vachon Monument
 East Face:
 VACHON
 West Face:
 NAPOLEON J. VACHON
 Aug. 15, 1902 - Oct. 30, 19
 his wife
 JEANNE H. MESSIER
 Mar. 23, 1907 - Jan. 7, 196
 their son
 JAMES D.
 Mar. 28, 1945

(R1#240) Hunton Monument
 East Face:
 MAE C. GAVIN HUNTON
 born Prince Edwards Island, Canada
 May 12, 1901
 died Brunswick, Maine
 April 3, 1968
 Mother of nine children

Marker Stones:
 (R1#241) FREDERICK L. HUNTON
 August 21, 1900
 May 9, 1946
 Lost at sea

Marker: U.S. Veteran

West Face:
 LILLIAN HUNTON LUCE SMITH
 BARBARA HUNTON CAMPBELL
 FREDERICK ARTHUR HUNTON
 FRED HUNTON
 JACK HUNTON
 JOAN HUNTON FICKETT
 HELENA HUNTON CELANO
 PATRICIA HUNTON
 KAREN HUNTON McGRADE

(R1#242) MAE C. HUNTON
 1901 - 1968

(R1#243) St. Pierre Monument
ST. PIERRE
ULRIC J. LUCIENNE C.
1904 - 1975 PLOURDE
1910 - 1988

(R1#245) (Recent burial, no stone)

(R1#247) Bouchard Monument
East Face:
BOUCHARD
ALCIDE N. MARY L.
1904 - 1968 1905 - 1989
West Face:
Daughter
BEVERLY A. KEENAN
1931 - 1994

(R1#250) Caouette Monument
CAOUCETTE
1899 J. ADELARD CAOUCETTE 1967
ROGER A. CAOUCETTE
his wife
JUDITH A. TOURTELOTTE

(R1#251) Bourque Monument
BOURQUE
1914 LEOPOLD T. BOURQUE 1967
son epouse
1920 JEANNE D'ARC PELLETIER

Marker: U.S. Veteran

Marker Stones:

(R1#252) LEOPOLD BOURQUE
Maine
Pvt HQ Co 1111 Casual Unit
Oct 8 1913 Nov 27 1967

(R1#244) Bernier Monument
East Face:
BERNIER
My Jesus mercy
West Face:
1906 EMILE "DOC" BERNIER 19
his wife
1910 ADRIENNE BELANGER 1

(R1#246) KATHERINE T. CONNOR
April 19, 1889 - Dec. 31, 1971

(R1#248) Boucher Monument
East Face:
IHS
BOUCHER
1961 MICHAEL D. 1968
Earth has no pain that heaven cannot heal
West Face:
1937 HENRY J. M. BOUCHER 20
his wife
1939 COLETTE E. BLANCHETTE

Marker Stone:
(R1#249) HENRY J BOUCHE
SP3 US Army
Jun 7 1937 May 22 20
Marker: U.S. Veteran

(R1#253) ANTONIO GAGNE
Maine
Cox US Navy
World War II
Jan 19 1916 Dec 3 1966

(R1#254) Gamache Monument
GAMACHE
1884 OCTAVE GAMACHE 1967
his wife
1893 MINNIE C. GILBERT 1972

(R1#255) MARCEL M FORTIN
Pvt US Army
World War II
Oct 30 1922 Dec 7 1988

(R1#256) Magee Monument
MAGEE
JOHN J. GLADYS T.
1883 - 1968 1886 - 1977
My Jesus mercy

(R1#257) Gagnon Monument
Jesus Marie Joseph
GAGNON
1904 JOSEPH 1968 - 1907 IRENE A. 1907

(R1#258) Saucier Monument
Thy will be done
SAUCIER
1930 RICHARD SAUCIER
his wife
1930 PAULINE BERGERON 1968

(R1#259) Bergeron Monument
BERGERON
POMELA E. In Gods AUGUST
1895 - 1970 care 1895 - 1970

(R1#260) Saucier Monument
East Face:
SAUCIER
1884 MAXIME 1983 1887 CLARISSE 1972
West Face:
1916 EDMUND SAUCIER 1992

(R1#261) Deorsey Monument
DEORSEY
1902 V. ARTHUR 1968
his wife
JULIETTE LAVALLEE
1903 - 1981
In God's care

(R1#262) Ouellette Monument
OUELLETTE
CONRAD G. MARGUERITE
1914 - 1995 1915 - 2005

(R1#263) SHULMAN
LUCIE L. HARRY G.
1902 - 1988 1908 - 1988

(R1#264) ANN I. MIKLOS
Feb. 13, 1918 - Feb. 13, 1989
Wife of JOHN ROSS
Married June 30, 1943

(R1#265) JOHN ROSS
Capt US Army
World War II
Feb 11 1918 Dec 25 1999

(R1#266) Fortin Monument
FORTIN
MARCEL M. MARY E.
Oct. 30, 1922 Sept. 9, 1922
Dec. 7, 1988 Oct. 11, 1991

Marker: U.S. Veteran

(R1#267) Bouchard Monument

BOUCHARD
RODOLPHE L.
Sept. 4, 1930 - May 9, 2007
NORMA OLIVER his wife
Oct. 21, 1930

Marker Stone:

(R1#268) RODOULPHE L BOUCHARD
SFC US Army
Korea
Sep 4 1930 May 9 2007

(R1#269) Laberge Monument

LABERGE
ROBERT J. RITA G.
June 24, 1914 Sept. 10, 1919
Jan. 21, 1998 Sept. 20, 2003
In God we trust

(R1#270) Ouellette Monument

OUELLETTE
In God's care
OMER G. PRISCILLE LEBE
1925 - 1928 -

(R1#271) DeOrsey Monument

DeORSEY
IHS
DOROTHY LEBEL RAYMOND ARTHUR
1927 - 2000 1924 - 1992

Marker Stone:

(R1#272) RAYMOND A DeORSEY
Cpl US Army
World War II
Aug 1 1924 Mar 7 1992

(R1#273) Morin Monument

MORIN
MAURICE A. THERESE A.
1918 - 1986 1928 - 2004
Our father who art in heaven

Marker Stone:

(R1#274) MAURICE MORIN Sr
Pvt US Army
World War II
Apr 18 1918 Jul 1 1986
"Earth hath no sorrow
that heaven cannot heal"

(R1#275) Sallesa Monument

SALLESA
1917 AMBROSE D. 1998
1924 wife EUGENIA A.
dau. LUCILLE A. FRASER
1955 - 1981

Marker Stone:

(R1#276) AMBROSE D SALLESA
US Navy
World War II
Apr 21 1917 Jan 30 1998

Marker: U.S. Veteran

(R1#277) Bernier Monument

ADELARD J.
BERNIER
July 10, January 17,
1905 1986

(R1#278) Rote Monument

ROTE
ROBERT W.
May 5, 1937 Mar. 4, 2001
GLORIA A. his wife
May 7, 1939 July 20, 1986

(R1#279) Earl Monument

EARL

Marker Stone:

(R1#280)

Our beloved child

DEBRA ANN

1958 - 1960

(R1#281)

PHILIPPON

RAOUL J. JUILLENNE O.

1909 1911 - 1992

(R1#283)

JOHN J COUGHLIN Jr

GY Sgt US Marine Corps

Sep 9 1928 Jan 10 2000

(R1#282)

MARIE - JEANNE

CARON

1905 - 1993

(R1#284)

FATHER

In God's care

(R1#285) Bisson Monument

BISSON

In God we trust

PAUL M. LORRAINE M.

July 4, 1917 Aug. 14, 1920

July 31, 1991

(R1#286)

DONAT

LABONTE

1903 1999

(R1#287) Busque Monument

BUSQUE

Marker Stones:

(R1#288)

RAOUL J. BUSQUE

1908 - 1974

son epouse

SIMONE NORMAND

1915 - 1995

(R1#289)

JULIETTE L.

1909 - 1948

(R1#290) Tourigny Monument

TOURIGNY

Marker Stone:

(R1#291)

MAURICE

(R1#292) St. Pierre Monument

ST. PIERRE

Wife

BARBARA A. JAMESON

Aug. 27, 1927 - Mar. 28, 1961

Husband

ROBERT A. ST. PIERRE

Apr. 21, 1920 -

(R1#293) Footer Monument

East Face:

FOOTER

West Face:

1897 GEORGE N. FOOTER 1968
1900 MARY J. his wife 1961
1939 MARY L. their dau. 1966
1934 GEORGE C. FOOTER 1982

Marker Stones:

(R1#294) MARY J
(R1#295) MARY L
(R1#296) GEORGE
(R1#297) GEORGE

(R1#298) Coughlin / Gamache Monument

East Face:

COUGHLIN
GAMACHE
In God's care

West Face:

JOHN J. COUGHLIN, Jr.
Sept. 9, 1928 Jan. 10, 2000
GRACE B. his wife
Dec. 28, 1919 Apr. 14, 2005
MARIE J. GAMACHE her sister
Apr. 10, 1918

Marker: U.S. Veteran

(R1#299) Arsenault Monument

ARSENAULT

Marker Stone:

(R1#300) ISRAEL J.
1908 - 1949

(R1#301) Arsenault Monument

East Face:

ARSENAULT

West Face:

1884 RENE L. ARSENAULT 19
epoux de
1890 MARIE RICHARD 19

(R1#302) Bernier Monument

East Face:

BERNIER

Dites nous un "je vous salue, Marie."

West Face:

1904 JOHN B. BERNIER 1964
son epouse
1904 ADELAIDE AUBE 1970
leur fille
1940 JOANNE T. BERNIER 1962
et leur fils
1927 JOSEPH L. BERNIER 1970

Marker: U.S. Veteran

Marker Stones:

(R1#303) JOANNE T. BERNIER
1940 - 1962
(R1#304) Mother
ADELAIDE
(R1#305) JOHN B. BERNIER
1904 - 1964
(R1#306) JOSEPH L BERNIER
Maine
US Navy
World War II
July 15 1927 Aug 27 1970

(R1#307) Viney Monument

VINEY
PAUL VINEY, Sr.
Oct. 9, 1882 - Feb. 26, 1962
his wife
HELENE MICHEL
Oct. 28, 1882 - Dec. 3, 1963
Say a Hail Mary

Marker Stones:

(R1#308) FATHER
(R1#309) MOTHER

(R1#310) Gamache Monument

East Face:

GAMACHE

West Face:

RAYMOND D. GAMACHE
July 3, 1933
PAULINE POULIN his wife
July 29, 1933
ROBERT GERARD their son
August 12, 1964 September 29, 1985

Marker Stone:

(R1#311) ROBERT G GAMACHE
A1 US Air Force
Aug 12 1964 Sep 29 1985
Marker: U.S. Veteran

(R1#313) Racine Monument

East Face:

IHS
RACINE

West Face:

HENRI RACINE
1871 - 1957
son epouse
DIANA RACINE
1879 - 1952
MELORE E. RACINE
1915 - 1991

(R3#312) Dube Monument

DUBE
1881 JOSEPH 195
1880 LOUISE 195
1886 JULES 196
1884 ELZIRE

Marker Stones:

(R1#314) DIANA RACINE
(R1#315) HENRI RACINE
(R1#316) MELORE RACINE

(R1#317) Giroux Monument

East Face:

GIROUX
"He longest lives who to others gives,
himself forgetting"

West Face:

WILFRID A. GIROUX Jr.
Feb. 9, 1930 - June 15, 1963

Marker Stone:

(R1#318) WILFRID A GIROUX Jr
Maine
RCT 501 QM Service Co
Feb 9 1930 June 15 1963

Marker: U.S. Veteran

(R1#319) Michaud / Talbot Monument

East Face:

IHS
MICHAUD - TALBOT
In loving memory

West Face:

LORENZO E. NOEL L.
1910 - 2001 1909 - 1984
his wife his wife
FRANCE H. VINEY LILLIAN VINEY
1910 - 2001 1908 - 1978

Marker Stone:

(R1#320) MOTHER

(R1#321) Knold Monument

KNOLD

JOHN I. ROSEMARY
Sept. 16, 1922 Sept. 23, 1922
June 21, 1998 Apr. 6, 1988
 ROSIE

Marker: U.S. Veteran

Marker Stone:

(R1#322) JOHN IVAN KNOLD
MN CS US Navy
World War II
Sep 16 1922 Jun 21 1998

(R1#323) Milton Monument

East Face:

MILTON

West Face:

1911 EVELYN DUVAL 1971
her husband
1902 JOHN MILTON 1953

(R1#324) Fortin Monument

East Face:

FORTIN

West Face:

1886 FLORIDO J. 1952
1886 ALEXINE J. 1952
their son
1915 EUGENE A. 1988
his wife
1925 ELIZABETH A.

(R1#325) Ouellette Monument

East Face:

OUELLETTE
Salve regina

West Face:

1904 ALFRED J. OUELLETTE 1981
son epouse
1901 ADELIN DESCHENES 1964
leur fille
1925 FLAVIA J. BISSON 1998

(R1#326) Lachance Monument

Wife

BLANCHE Y.
1913 - 1964

Holy Mary
pray for us
LACHANCE

Husband

OLIVA P.
1918 - 1997

Marker Stones:

(R1#327)

Mere
EMILIA JALBERT
11, Mars 1888
2, Mars 1964

(R1#328)

BLANCHE LACHANCE
epouse de
OLIVA LACHANCE
1913 - 1964

(R1#329) Dubois Monument

East Face:

DUBOIS

Coeur de Jesus, soit notre salut

West Face:

ALCIDE J. DUBOIS

22 Sept. 1887 - 23 Mai 1962

son epouse

DELIA LEMLIN DUBOIS

9 Juin 1883 - 18 Mai 1956

fil

ELMER J.

22 Fev. 1913 - 8 Aout 1991

son epouse

ADRIENNE M. DUBOIS

5 Mai 1914 - 11 Aout 1988

Marker Stones:

(R1#330) MOTHER

(R1#331) FATHER

(R1#332) WIFE

(R1#333) HUSBAND

(R1#334) Labbe Monument

East Face:

LABBE

Coeur sacre de Jesus, ayez pitie de nous

West Face:

PHILLIP LABBE, Sr.

4 Sept. 1884 - 28 Dec. 1955

son epouse

ADELE MENARD

16 Juil. 1884 - 31 Janv. 1980

fil

ADELARD J.

7 Fev. 1911 - 1 Sept. 1998

son epouse

ANNA M. BERNIER

21 Janv. 1910 - 3 Avr. 1999

Marker: U.S. Veteran

Marker Stones:

(R1#335) PERE

(R1#336) MERE

(R1#337) ADELARD J LABBE

PFC US Army

World War II

Feb 7 1911 Sep 1 1998

(R1#339) Jalbert Monument

East Face:

JALBERT

Mon Jesus misericorde

West Face:

1888 EMILIA JALBERT 196

1909 LAURIER E. JALBERT 200

son epouse

1909 MARGUERITE DESJARDINS 200

(R1#338) Pinette Monument

East Face:

PINETTE

Jesus Mary Joseph

West Face:

1906 LUCIEN J. PINETTE 1999

his wife

1904 CECILE Y. BRASSARD 1991

(R1#340) Elwell Monument

East Face:

ELWELL
In loving memory

Marker Stone:

(R1#341)

GEORGE D ELWELL
US Army
World War II
1923 2005

West Face:

1923 GEORGE D. ELWELL 2005
his wife

1926 FERNANDE FOURNIER 2001
their children

1959 RONALD G. 1959

1966 LISA MARIE 1977

(R1#343)

ALFRED X BELANGER
Maine
Pvt 6 Co 151 Depot Brig
World War I
June 19 1896 Sept 9 19

(R1#342)

YVONNE A. BELANGER
May 13, 1900 July 7, 1957

(R1#344)

EDWINA D. ST. PIERRE
May 31, 1933 - May 29, 2007
Beloved wife of
ROBERT J. ST. PIERRE

(R1#345)

ROBERT J. ST. PIERRE
June 22, 1917
Sept. 24, 1985

(R1#346) Moffett Monument

East Face:

MOFFETT

West Face:

1921 RAYMOND H. 1997
his wife

1921 MARGARET M. 1977
their daughter

1950 LYNNE M. 1967

Marker: U.S. Veteran

Marker Stone:

(R1#347) RAYMOND H MOFFETT
ARM1 US Navy
World War II
Jul 16 1921 Feb 8 1997

(R1#348) St. Pierre Monument

East Face:

ST. PIERRE

West Face:

1896 MICHEL ST. PIERRE 1981
his wife

1898 BLANCHE M. LAVIGUEUR 1999
their daughter

1934 N. JOAN ST. PIERRE 1967

Marker: U.S. Veteran

Marker Stone:

(R1#349) MICHEL ST PIERRE
Pvt US Army
World War I
1896 1981

(R1#350) Gaudreau / Lamarre Monument

East Face:

Sainte mere de dieu priez pour nous
GAUDREAU - LAMARRE

Marker Stones:

(R1#351) DELIA BOURGOIN
30 Sept 1901 - 9 Aout 1977
epouse de
ALBERT GAUDREAU

West Face:

26 Dec. 1901 ALBERT GAUDREAU 10 Juin 1977
son epouse
30 Sept. 1901 DELIA BOURGOIN 9 Aout 1957
24 Fev. 1933 RICHARD LAMARRE
son epouse
29 Dec. 1932 CONSTANCE GAUDREAU
leur fils
2 Juil. 1962 RICHARD P. LAMARRE 27 Sept. 1962

(R1#352) Belanger Monument

East Face:

Rest in peace
BELANGER
All I ask of you is forever
to remember me as loving you

Marker Stones:

(R1#353) Rest in peace
Beloved Father
LAURIER

West Face:

LAURIER E. BELANGER
Jan. 8, 1915 - Sept. 10, 1957
his wife
CYRIENNE B. CLOUTIER
Dec. 20, 1913 - Apr. 22, 2001
their son
CHARLES L. BELANGER
June 29, 1945 - Nov. 12, 2002
his wife
SALLY A. LOWE
June 24, 1945 -

(R1#354) Rest in peace
Beloved Mother
CYRIENNE

(R1#355) Rest in peace
Beloved Son
CHARLES

(R1#356) Rest in peace
Beloved Wife
SALLY ANN

(R1#357) Lachance Monument

LACHANCE
EMERY EDWIDGE
1900 - 1983 1899 - 1984

(R1#358) Bouchard Monument

East Face:

BOUCHARD

West Face:

OLIVA HENRY BOUCHARD
1903 - 1968
his wife
EMILIENCE PAINCHAUD
1904 - 2001

(R1#359) Bisson / Paskoski Monument

East Face:

IHS BISSON
 PASKOSKI
All I ask of you is forever to
remember me as loving you.

Marker Stone:
(R1#360)

LOUIS A J BISSON
PFC US Marine Corps
Nov 16 1935 Aug 14 1987

West Face:

 LOUIS A. J. BISSON
 Nov. 16, 1935 * Aug. 14, 1987
Apr. 18, his wife Mar. 3,
1959 JACQUELINE M. LAMARRE 1986
 Oct. 25, 1935 -
 RICK A. PASKOSKI
 Nov. 24, 1963 *
 his wife
 KELLY-ANN A. BISSON
 Oct. 3, 1968

(Dates to left and right below two interlocking rings.
U.S. Marine Emblem between upper dates, U.S. Navy
Emblem after third date line.)

(R1#361) Yanok Monument

East Face:

 YANOK
 "Say a Hail Mary"

Marker Stones:
(R1#362)

ANNA M. YANOK
June 1, 1914
Jan. 2, 2000

West Face:

 GEORGE J. YANOK
 May 27, 1886 - Apr. 6, 1959
 his wife
 ANNA LEMES
 Oct. 24, 1892 - Sept. 14, 1984

(R1#363)

GEORGE M YANOK
PFC US Marine Corps
World War II
May 17 1918 Feb 12 1988

Marker: U.S. Veteran

(R1#364) Lamarque Monument

 LAMARQUE

 Husband Wife
 ROGER F. LAMARQUE CLAIRE E. PHILIPPON
 Sept. 4, 1913 - May 12, 1959 Nov. 21, 1918 - Nov. 19, 2005
 All I ask of you is forever to remember me as loving you

Marker: U.S. Veteran

Marker Stones:

(R1#365)

ROGER F LAMARQUE
Maine
S2 US Navy
World War II
Sept 4 1913 May 12 1959

(R1#366)

CLAIRE E. PHILIPPON
wife of
ROGER F. LAMARQUE

(R1#367) Bernier Monument

BERNIER
1919 RUSSELL G. BERNIER
his wife
1913 ANITA A. TETU 2005
their daughter
1947 MELITA G. BERNIER 1985
In loving memory

(R1#368) Morin Monument

MORIN
DOMINIC J. M. LORRAINE
1937 - 1937 - 1984
In God's care

(R1#369) Labbe Monument

IHS
LABBE
Into thy hands we commend our spirit

Marker Stones:

(R1#370)

Husband
ADELARD J.
July 26, 1908
Oct. 5, 1985

(R1#371)

Wife
RUTH I. VIGEANT
June 26, 1918
May 3, 1995

(R1#372)

Son
ROBERT M.
Aug. 6, 1938

(R1#373)

Son
ARTHUR J.
July 26, 1939
Jan. 26, 2000

(R1#374) Michaud Monument

MICHAUD
RUSSELL A. DANIEL R.
1929 - 1953 - 1986
his wife his wife
YVETTE C. FLORENCE E.
1930 - 2002 1953 -

(R1#375) Lord Monument

LORD
Two souls
side by side, forever
in silent
unspeakable memories
GERARD A. M. LUCILLE
LORD (GIROUX)
1934 - 1992 1934 - 1995

Marker: U.S. Veteran

Marker Stone:

(R1#376)

GERARD A LORD
MSgt US Air Force
Korea Vietnam
Apr 8 1934 May 29 1992

(R1#377) Crockett Monument

CROCKETT
Together forever

Marker: U.S. Veteran

Marker Stones:

(R1#378)

ROBERT L CROCKETT
AMS3 US Navy
World War II
Apr 27 1921 Feb 5 1986

(R1#380) Caouette Monument

CAOUCETTE

Marker Stones:

(R1#381)

MABEL
1900 - 1948

(R1#382)

HENRY A.
1897 - 1963

(R1#379)

BERTHA R. CROCKETT
wife of
ROBERT L. CROCKETT
Mar. 31, 1921 Nov. 6, 2006

(R1#383)

JOSEPHINE DIONNE
1877 - 1967

(R1#384) Courtemanche Monument

COURTEMANCHE

Marker Stones:

(R1#385)

PHILONISE
1871 - 1948

(R1#387)

WILLIAM
1903 - 1958

(R1#386)

BARBARA
1902 - 1955

(R1#388)

BLANCHE
1896 - 1975

(R1#389) Paradis Monument

PARADIS
1891 ALCIDE 1948
1888 EVA son epouse 1971
1923 ROBERT son 2006

Marker: U.S. Veteran

Marker Stones:

(R1#390)

ALCIDE PARADIS
Maine
PFC 303 Field Arty 76
World War I
Jan 10 1891 Aug 12 1948

(R1#391)

ROBERT L PARADIS
GM3 US Navy
1923 2006

(R1#392) Marquis Monument

East Face:

MARQUIS

Marker Stone:

(R1#393)

ROMEO H MARQUIS

West Face:

1892 HENRY H. MARQUIS 1968

his wife

1895 LAURA A. EMOND 1962

1917 Cpl. ROMEO H. MARQUIS 1945

1925 JULIETTE L. GRINDLE

1933 WILLIAM T. MARQUIS

Maine

Cpl 103 Inf

World War II

June 2 1917 May 24 1945

Marker: U.S. Veteran

(R1#394) Coulombe Monument

COULOMBE

JOSEPH O.

Daughter

ELISIANNE G.

1869 - 1949 1900 YVONNE M. 1985

1875 - 1931

(R1#395) Bouchard / St. Pierre Monument

BOUCHARD

Marker Stones:

ST. PIERRE

(R1#396)

PERE

VALERIE ARTHUR L.

1883 - 1949 1912 -

(R1#397)

REGINA B. ST. PIERRE

REGINA B. REGINA B.

1918 - 2007

1887 - 1950 1918 - 2007

wife of

ARTHUR L. ST. PIERRE

Marker: U.S. Veteran

(R1#398) Levesque Monument

ANTOINE

1912 - 1949

MARIE LOUISE

1913 - 1953

LEVESQUE

(R1#399) Croteau Monument

East Face:

CROTEAU

FERNANDE E. GAUDETTE

PHILIPPE H. CROTEAU

1907 - 1950

1902 - 1972

West Face:

son epouse

1911 LUCIENNE MENARD 1994

(R1#400) Gervais Monument

GERVAIS
 1882 STANISLAS 1935
 his wife
 1887 CORINNE TONDREAU 1976
 -
 1911 JOE J. MORIN 1979
 his wife
 1914 JEANNETTE GERVAIS 2004

(R1#401) Tondreau Monument

East Face:
 TONDREAU
 West Face:
 1881 ADJUTOR E. TONDREAU 1
 son epouse
 1894 BERNADETTE DESJARDINS 1
 fille
 1922 EVELYN G. TONDREAU 1

(R1#403) Messier Monument

East Face:
 MESSIER
 Jesus Marie Joseph
 West Face:
 1897 LORENZO J. MESSIER 1977
 son epouse
 1893 LAURA A. SAINDON 1976
 1927 LOUIS J. MESSIER 1968

Marker: U.S. Veteran

Marker Stones:

(R1#404) MOTHER
 1893 - 1976

(R1#405) FATHER
 1897 - 1977

(R1#406)

LOUIS J MESSIER
 Maine
 S1 USNR
 World War II
 March 16 1927 Jan 26 1968

(R1#407) Berube Monument

BERUBE

Marker: U.S. Veteran

Marker Stones:

(R1#408) EVA ST. PIERRE
 1891 - 1952
 epouse de
 THOMAS BERUBE

(R1#409) THOMAS BERUBE
 1885 - 1960

(R1#410) MARIE BERUBE
 1910 - 2003

(R1#412) LUDGER BERUBE
 S2 US Navy
 World War II
 Apr 24 1916 Sep 11 2004

(R1#411) LUDGER BERUBE

(R1#413) White Monument

East Face:

WHITE

Marker Stone:

(R1#414)

SUZANNE T. AL

West Face:

1919 THEODORE R. WHITE Sr. 1977

1917 DIANA O. his wife 1963

1952 ROBERT E. their son 1952
their dau.

1953 SUZANNE WHITE ALMY 1984

March 7, 1953

January 3, 1984

(R1#415) Labbe Monument

East Face:

LABBE

(R1#416) Morin Monument

East Face:

MORIN

West Face:

LOUIS J. LABBE

1905 - 1983

MADELAINE S. LABBE

1914 -

RICHARD LABBE

1936 - 1952

West Face:

1908 DOMINIC P. MORIN 1908

1910 SIMONNE A. son epouse 1910

(R1#417) Mendes Monument

East Face:

MENDES

Marker Stones:

(R1#418)

MARY J. PRIESTLY

April 22, 1914

November 22, 2005

West Face:

JOSEPH C. MENDES

Apr. 3, 1900 - July 15, 1952

his wife

MARY PRIESTLY MENDES

Nov. 5, 1902 - Apr. 12, 1976

(R1#419)

JOHN E. PRIESTLY, Sr.

July 2, 1909

April 30, 1958

(R1#420) Girard Monument

East Face:

GIRARD

Marker Stones:

(R1#421)

Husband

DIDACE J.

Jan. 26, 1908

Oct. 4, 1982

West Face:

DIDACE J. GIRARD

Jan. 26, 1908 - Oct. 4, 1982

his wife

JULIETTE PHILIPPON

June 10, 1906

(R1#422)

Wife

JULIETTE

June 10, 1906

(R1#423)

ROSE A. PHILIPPON

wife of

J. EUGENE ST. PIERRE

(R1#424)

J. EUGENE ST. PIERRE

husband of

ROSE A. PHILIPPON

(R1#425) Lachance Monument

East Face:

LACHANCE

West Face:

1893 EDDIE J. LACHANCE 1960
son epouse
1895 JOSEPHINE M. COTE 1952

(R1#426) Michaud / Fougere Monument

East Face:

MICHAUD
FOUGERE

West Face:

1900 OVIDE J. MICHAUD 1
1904 HILDEA M. son epouse 2
1930 HUBERT A. FOUGERE
1933 CLAUDETTE A. son epouse

(R1#427) Bernier Monument

East Face:

Corporal
WILFRED J. BERNIER
U. S. M. C.

West Face:

ALDERIC JOSEPH BERNIER
1895 - 1972
MARIE LUCIENNE BERNIER
1905 - 1981
Corporal WILFRED J. BERNIER
1930 - 1952

Marker: U.S. Veteran

Marker Stones:

(R1#428) WILFRED J BERNIER
Maine
Cpl 5 Marines 1 Mar Div
World War II Korea PH
Jan 27 1930 Dec 21 1952

(R1#429) ALDERIC BERNIER
Maine
Pvt Co M 74 Inf 12 Div
World War I
July 26 1895 Dec 23 1972

(R1#430) Lord Monument

East Face:

LORD

Vous quipasser, priez pour nous

West Face:

JOSEPH F. LORD
Feb. 12, 1879 - Aug. 20, 1962
son epouse
MARIE DELIMA BELANGER
Mar. 4, 1887 - May 2, 1939
son fils
FERNAND P. LORD
May 1, 1912 Nov. 11, 1975

(R1#431) D'auteuil Monument

East Face:

D'AUTEUIL

West Face:

1869 NAZAIRE D'AUTEUIL 19
son epouse
1872 HERMINE DESBIENS 19
1904 DELIA E. 19
1910 NAZAIRE W. 19

(R1#433) Brillant Monument

East Face:

BRILLANT

In
God's
Care

West Face:

GEORGETTE C. BRILLANT
Feb. 11, 1922 - May 18, 2000
ANN MARIE her daughter
Dec. 13, 1954 - Dec. 27, 1954

(R1#432) Boucher Monument

East Face:

G. BOUCHER

West Face:

1901 GERARD A. 1990
his wife
1901 MARY O. 1955

Marker Stones:

(R1#434) Daughter
ANN

(R1#435) Mother
GEORGETTE

(R1#436) DIANNE MARIE
daughter of
Mr. and Mrs. W. H. HUGHES
Apr. 17, 1954 - June 6, 1954

(R1#437) Bergeron Monument
Father Mother
EDGAR BERGERON FLORENCE DEFORCE
1907 - 1968 1909 - 1990
BERGERON

(R1#439) Thibeault Monument
East Face:
THIBEAULT
Thy
will be
done.
Jesus Mary Joseph

Marker Stone:
(R1#438) ROLAND J BERGERON
Maine
PFC US Army
Vietnam
March 25 1941 Sept 3 1970

West Face:
1900 OVILA J. THIBEAULT 1975
his wife
1902 IDA H. DEROSIER 1963
their son
1923 ROGER J. THIBEAULT 1954

Marker Stone:
(R1#440) Husband
ROGER J. THIBEAULT
May 22, 1923
Feb. 23, 1954

(R1#441) Vaillancourt Monument
East Face:
VAILLANCOURT

Marker Stone:
(R1#442) Our beloved child
DEBRA JEAN
Mar. 4, 1953 - Dec. 30, 1953
Daughter of
MITCHELL and VIOLET
VAILLANCOURT

West Face:
MITCHELL J. VAILLANCOURT
March 28, 1924
his wife
VIOLET DIONNE VAILLANCOURT
January 14, 1926
their daughter
DEBRA JEAN VAILLANCOURT
March 4, 1953 December 30, 1953

(R1#443) Allard / Brillant Monument
ALLARD BRILLANT
RUDOLPH JOSEPH L.
Apr. 10, 1897 July 31, 1927
Feb. 22, 1954 Mar. 1, 2001
ELIZABETH GRACE E.
Nov. 1, 1905 Aug. 4, 1927
Sept. 18, 1993

Marker Stones:
(R1#444) JOSEPH L BRILLANT
Tec 5 US Army
World War II
Jul 31 1927 Mar 1 2001
(R1#445) RUDOLPH ALLARD

(R1#446) Bisson Monument

East Face:

BISSON

Marker Stone:

(R1#447)

RONALD JOSEPH son of
MAURICE J. & HELENE P. BISSON
June 3, 1957 - June 5, 1957

West Face:

HELENE P. MAURICE J.
Mar. 6, 1937 Mar. 9, 1935
Mar. 16, 1993
Married June 2, 1956
RONALD J. BISSON
June 3, 1957 - June 5, 1957

(R1#448) Dionne Monument

East Face:

Life is short
and the art long.
The occasion instant
experiment perilous
decision difficult.

DIONNE

West Face:

MAURICE J. DIONNE, M.D.
1904 - 1973
wife
BEATRICE NEWTON
1914 - 2003

BERTRAND B. DIONNE
1915 - 2001
wife
BERNICE ODGEN
1915 - 1970
daughter
SARAH ELLEN
1949 - 1957

Marker Stones:

(R1#449) BERNICE ODGEN DIONNE
Feb. 18, 1915
Feb. 9, 1970

(R1#450) Our beloved daughter
SARAH ELLEN DIONNE
Jan. 26, 1949
May 14, 1957

(R1#451) Michaud Monument

MICHAUD
wife

Marker Stone:

(R1#452) MOTHER

1889 LEONIE LABEL 1958
daughter
1925 EVELINE MICHAUD

(R1#453) Levesque Monument

East Face:

Coeur sacre de Jesus, ayez pitie de nous
LEVESQUE

Marker Stones:

(R1#454)

LEVESQUE
PHILIPPE LUMINA
1886 - 1956 1888 - 1972

West Face:

PHILIPPE LEVESQUE
13 Sept. 1886 - 1 Juil. 1956
son epouse
LUMINA NADEAU
20 Mai 1888 - 28 Oct. 1972
fils
LUDGER L. LEVESQUE
7 Mai 1910 - 11 Sept. 1981

(R1#455)

Brother uncle friend
LUDGER L.
LEVESQUE
May 7, 1910 - Sept. 11, 1981
His kindness and love for his fan
will live forever in our hearts

(R1#456) Pinette Monument

East Face:

PINETTE
IHS ARTHUR ALMA
1885 - 1957 son epouse
1888 - 1979

Marker Stone:

(R1#457)

FATHER

West Face:

THERESE L. PINETTE
1911 - 1984
MARIE LAURE PINETTE
1909 - 1992

(R1#458) Beaulieu / Lagasse Monument

BEAULIEU LAGASSE
mother husband
EMELIA B. ONEZIME
1886 - 1958 1917 - 1997
son wife
GERALD BERNADETTE
1910 - 1979 1916 - 1996

Marker Stones:

(R1#459)

ONESIME C LAGASSE
Tec 4 US Army
World War II
Apr 7 1917 May 3 1997

(R1#460)

PATRICK R LAGASSE
SP5 US Army
Vietnam
May 17 1950 Nov 15 2006

Marker: U.S. Veteran

(R1#461) Trusiani Monument

East Face:

TRUSIANI
wife husband
ISABELLE L. CESARE
1909 - 1971 1897 - 1972

West Face:

STEPHEN P. TRUSIANI
1957 - 1958
ARTHUR O. TRUSIANI
1932 - 1999

Marker Stone:

(R1#462)

ARTHUR O TRUSIANI
PFC US Army
Korea
Jan 13 1932 Feb 4 1999

Marker: U.S. Veteran

(R1#463) Laferriere Monument

East Face:

LAFERRIERE
Dites un "je vous salue, Marie"

West Face:

JOSEPH FELIX LAFERRIERE
16 Oct. 1901 - 10 Oct. 1958
son epouse
ROSE ALBERT LAFERRIERE
1 Mars 1908 - 29 Janv. 1986
leurs fils
ROBERT FELIX LAFERRIERE
18 Nov. 1930 -
ROLAND FELIX LAFERRIERE
29 Nov. 1931 -

Marker Stones:

(R1#464)

PERE

(R1#465)

MERE
ROSE LAFERRIERE
LAVIGNE

(R1#466)

SANDRA W. SPENCE
1967 - 1990

(R1#467) Bernier Monument

East Face:

BERNIER

West Face:

1884 ADELARD BERNIER 1958
son epouse
1886 MARIA L. LECLERC 1974
leur fille
1913 MARIE PAULE

Marker Stones:

(R1#468)

Father
ADELARD
1884 - 1958

(R1#469)

Mother
MARIA L.
1886 - 1974

(R1#470)

Daughter
MARIE PAULE
1913 - 1992

(R1#471) Kopatz Monument

KOPATZ
CHARLES H. KOPATZ
July 31, 1879 - Apr. 1, 1959
his wife
HENRIETTE M. LEMANE
Mar. 17, 1900 - Jan. 25, 1980
Say a Hail Mary

Marker: U.S. Veteran

Marker Stones:

(R1#472) CHARLES H. W. KOPATZ
U.S. Naval Reserve
Merchant Marine

Marker: U.S. Veteran

(R1#473) LaFOREST L ALEXANDER
Cpl US Army
World War II
May 12 1918 Apr 8 1988

(R1#475) Johnsen Monument

East Face:

JOHNSEN
Say a Hail Mary

West Face:

ROLF M. JOHNSEN
Aug. 7, 1923 - Sept. 8, 2003
his wife
LORRAINE E. SANTERRE JOHNSEN
Jan. 8, 1922 -
their children
1958 KAREN LYNN 1958
1959 KEVIN MARTIN 1959

Marker: U.S. Veteran

(R1#474) Levesque Monument

East Face:

LEVESQUE
Dites un "je vous salue, Marie"

West Face:

ALFRED LEVESQUE
1882 - 1960
son epouse
ANNIE DRAPEAU LEVESQUE
1880 - 1961
leurs enfants
ANITA LEVESQUE DEVIN
1905 - 1998
LUDGER R. LEVESQUE
1907 - 1959

Marker Stones:

(R1#476) ROLF M JOHNSEN
GM2 US Navy
World War II
Aug 7 1923 Sep 8 2003

(R1#477) KAREN

(R1#478) KEVIN

(R1#479) Dugal Monument

East Face:

DUGAL
O Mary our hope, pray for us

Marker: U.S. Veteran

West Face:

RAYMOND G. DUGAL
May 8, 1913 - Mar. 15, 1997
his wife
GERMAINE A. CAOUETTE
Aug. 18, 1920 - Jan. 26, 2004
their son
MARK G. DUGAL
May 28, 1958 - Dec. 20, 1959

Marker Stone:

(R1#480) RAYMOND G DUGAL
PFC US Army
World War II

(R1#481) Fortier Monument

East Face:

FORTIER

West Face:

EDOUARD FORTIER

18 Septembre 1899

14 Janvier 1960

epouse

ELIANE BERNIER

12 Janiver 1908

29 Juin 1987

-

soeur

GERMAINE BERNIER

27 Oct 1912 27 Juin 1991

(R1#482) Ritchie Monument

East Face:

RITCHIE

West Face:

MARGARET E. RITCHIE

1891 1987

her daughter

BARBARA R. LAMARRE

1918

(R1#483) Saindon Monument

SAINDON

1890 ALFRED A. 1965

1896 OLIVINE L. 1979

Marker: U.S. Veteran

Marker Stones:

(R1#484)

ALFRED A SAINDON

Maine

Pvt Co A 101 Engrs

World War I PH

March 28 1890 Nov 27 1965

(R1#485)

THERESE H SAINDON

ADE 3 US Navy

World War II Korea

Sep 19 1923 May 6 1981

(R1#486) Levesque Monument

IHS

LEVESQUE

1914 ADRIEN LEVESQUE 1985

his wife

1923 YVETTE PARADIS

In God's care

(R1#487)

CONSTANCE BLACKIE

Dec. 18,

1921

Nov. 1

1987

(R1#488) St.Pierre Monument

ST.PIERRE

"Skippy" THERESE L.

ROLAND L. May 18, 1924

Nov. 6, 1922

Oct. 2, 2001

Marker: U.S. Veteran

(R1#489) Owen Monument

JUSTIN L.

OWEN

Dec. 20, 1986

Feb. 12, 1987

son of

HAROLD & DONNA

In God's care

(R1#490) Ouellette Monument

OUELLETTE

ROBERT J. SYLVIA B.
Mar. 27, 1916 Feb. 18, 1917
Apr. 21, 2007

(R1#491) Bisson Monument

BISSON

JOSEPH A. ALICE T.
Jan. 15, 1928 June 2, 1928

(R1#492) Belanger Monument

BELANGER

GERARD H. 1926 - 1987
DORIS M. 1928

Marker Stone:

(R1#493) GERARD H BELANGER
Cpl US Marine Corps
World War II
Jul 7 1926 Jun 14 1987

(R1#494) Doyon Monument

DOYON

1922 GERARD J. 1987
his wife
1924 IRENE B.
Together forever

(R1#495) Guptill Monument

GUPTILL

ROY VAUGHN GUPTILL
Oct. 13, 1905 - Nov. 1, 1995
his wife
CHARLOTTE Y. OUELLETTE
Mar. 14, 1920 - Mar. 8, 2005

(R1#496) Hill Monument

HILL

EDWARD WILLIAM
June 9, 1921 - Aug. 20, 2000
his wife
ANITA RAYMOND
Dec. 19, 1920 - Sept. 8, 2001

Marker Stone:

(R1#497) EDWARD W HILL
2nd Lt US Army
World War II
Jun 9 1921 Aug 20 2000

(R1#498) Coulombe Monument

COULOMBE

ALCIDE COULOMBE
1895 -
son epouse
FLORIDA PAQUETTE
1889 - 1964
Salve regina

Marker Stones:

(R1#499) FLORIDA PAQUETTE
1889 - 1964
epouse de
ALCIDE COULOMBE

(R1#500) ALCIDE J COULOMBE
Pvt US Army
World War I
Nov 2 1895 Jun 3 1978

(R1#501) Coulombe Monument

COULOMBE

Aug. 3, 1948
ARTHUR J. ANNETTE B.
July 19, 1914 Apr. 12, 1925
Aug. 13, 2001

(Pair of interlocking rings
over date at top)

Marker Stone:
(R1#502) ARTHUR A COULOMBE
Pvt US Army
World War II
Jul 19 1914 Aug 13 2001

(R1#503) Belanger Monument
BELANGER
HENRI J. BELANGER
13 Oct. 1899 - 26 Avr. 1960
son epouse
EMMA LEVESQUE
31 Oct. 1903 - 15 Oct. 1980

(R1#504) Ritchie Monument
RITCHIE

MAUDE M. JAMES H.
1883 - 1960 1882 - 1963

(R1#505) Bernier Monument

BERNIER

Husband

Wife

GEORGE BERNIER JEANNETTE LETOURNEAU
1906 - 1960 1913 - 2002

(R1#506) Normand Monument

NORMAND

Epouse

Epoux

JEANNE BELANGER ROBERT NORMAND
18 Mai 1900 4 Sept. 1904
20 Janv. 1960 3 Fev. 1968

Jesus misericorde

(R1#507) Belanger Monument

BELANGER

1904 LUDGER 1964

son epouse

1904 ALICE 1983

St. Therese priez pour noi

(R1#508) Orne Monument

ORNE

MERLE E. ORNE

1912 - 1996

his wife

IDA M. BOURASSA

1909 - 1965

Jesus Mary Joseph

(R1#509) Loewe Monument

LOEWE

JOHN J. LOEWE

Feb. 14, 1893 - Apr. 12, 1960

his wife

ALBERTA M. COULOMBE

Feb. 23, 1893 - May 29, 1980

My Jesus mercy

(R1#510) Landry Monument

LANDRY

MILDRED E. RAYMOND J.

Dec. 1, 1917 Feb. 2, 1913

Nov. 9, 1960 Sept. 23, 1988

Marker: U.S. Veteran

(R1#511) ESTHER DUBE

1919 - 1960

(R1#512) Levesque Monument

LEVESQUE

wife

husband

MARIE T. TALBOT IRENEE G. LEVESQUE

Apr. 27, 1913 July 26, 1912

Sept. 18, 1960 Nov. 6, 1984

Say a Hail Mary

(R1#513) Michaud Monument

MICHAUD

1893 CHARLES E. MICHAUD 1971

son epouse

1899 GRACIA THIBAUT 1996

Jesus Marie Joseph

(R1#514) White Monument

WHITE

LAWRENCE C. IRENE M.
Jan. 8, 1911 Mar. 10, 1913
Feb. 2, 1965 Oct. 3, 1968

Marker Stone:

(R1#515)

LAURENCE C WHITE
Maine
Pvt 1920 Svc Comd Unit
World War II
Jan 11 1911 Feb 2 1965

(R1#516)

JOHN N HEDERMAN

Maine

Sgt 843 AAA AW Bn CAC
World War II
Aug 24 1912 July 16 1961

(R1#517) Dube Monument

DUBE

ZEPHIRIN G. DUBÉ
1876 - 1962
son épouse
AZEL DUBE
1872 - 1961

(R1#518) Paquette Monument

IHS

PAQUETTE

May 13, 1888 LEON PAQUETTE June 6, 1961
his wife

Oct. 10, 1894 MARIA LACHANCE May 31, 1977
Please say a Hail Mary

Marker Stone:

(R1#519) LEON L PAQUETTE

Maine

Pvt Co C73 Infantry
World War I

May 13 1888 June 6 1961

(R1#520) Jacques Monument

East Face:

JACQUES

Say a Hail Mary

West Face:

EVERETT F. JACQUES
June 24, 1907 - May 27, 1961
his wife

CLARA SAUCIER
Apr. 5, 1908 - Nov. 6, 1991
Gentle woman

(R1#521) Boucher Monument

BOUCHER

ANTONIO J. Jesus IDA L.
1908 - 1965 Marie 1910 - 1991
Joseph

(R1#522) Bernier Monument

East Face:

BERNIER

West Face:

1913 ROLAND P. BERNIER 1965

(R1#523) Pelletier Monument

PELLETIER

LUDGER E. PELLETIER
Mar. 9, 1895 - June 28, 1962
his wife

EDITH E. RAYMOND
May 27, 1892 - May 21, 1976
"Say a Hail Mary"

(R1#524) Normand Monument

NORMAND

ARTHUR A. ROSIE P. T.
1915 - 1962 1932 - 1998

Marker Stones:

(R1#525) ARTHUR A NORMAND
 Maine
 SFC US Army
 World War II
 Oct 23 1915 April 21 1962

(R1#526) ROSIE P. T. NORMAND
 wife of
 ARTHUR NORMAND
 1932 1998

(R1#527) Richard Monument

 RICHARD
 HENRY J. MARIE F.
 1895 - 1968 1894 - 1962

(R1#528) Lamarre Monument

 Hail Mary, Holy Mary
 LAMARRE
 AUGUSTE YVONNE
 1893 - 1961 1900 - 1971

(R1#529) Bouley Monument

 BOULEY
 wife husband
 LEONA M. SATHURNIN J.
 1901 - 1965 1896 - 1968
 Rest in peace

Marker Stones:

(R1#530) MOTHER

Marker: U.S. Veteran

(R1#531) SATHURNIN BOULEY
 Maine
 Pvt Co A 212 Engineers
 World War I
 Dec 25 1896 July 17 1968

(R1#532) Morrill Monument

 MORRILL
 JAMES P. GLENORA D.
 Feb. 27, 1905 Feb. 24, 1912
 Sept. 26, 2003 July 23, 1988

(R1#533) Livernois Monument

 LIVERNOIS
 LAVAL N. LIVERNOIS
 Feb. 22, 1916 - Oct. 7, 1993
 his wife
 YVETTE M. CARLSON
 Feb. 21, 1918 - Jan. 24, 1963
 My Jesus mercy

(R1#534) Smart Monument

 SMART
 husband wife
 THOMAS SMART ANNA BLANCHETTE
 Mar. 26, 1887 May 9, 1893
 Dec. 12, 1962 Mar. 9, 1980

(R1#535) St. Pierre Monument

 ST. PIERRE
 IHS 1911 J. ADELARD ST. PIERRE 1972
 his wife
 1911 IDA R. DESBIENS 1972
 In God's care

(R1#536) Gamache Monument

East Face:

GAMACHE
My Jesus mercy

West Face:

Mother	Father
JEANNE M. TARDIFF	ROLAND GAMACHE
Apr. 14, 1916	Nov. 15, 1916
Mar. 13, 2000	Oct. 21, 1962
In loving memory	

(R1#537) Fowler Monument

East Face:

FOWLER
1909 DONALD FOWLER 1965
Let perpetual light shine upon him

Marker Stones:

(R1#538)	BEA
(R1#539)	DON

West Face:

ELIZABETH B. MacDONALD
1885 - 1972

(R1#540) Lapointe Monument

East Face:

LAPOINTE
Thy will
be done

Marker Stones:

(R1#541)	HUSBAND
(R1#542)	WIFE

West Face:

1900 JOSEPH A. LAPOINTE 1965
his wife
1903 MARY BLANCHARD 1992

Marker: U.S. Veteran

(R1#543) Dufresne Monument

East Face:

DUFRESNE
Jesus Marie Joseph

West Face:

ODIAS DUFRESNE
9 Janv. 1893 1 Aout 1971
son epouse
EDITH RACINE
10 Janv. 1900 14 Nov. 1974

(R1#544) Menard Monument

MENARD

Marker: U.S. Veteran

Marker Stones:

(R1#545) JOSEPH E MENARD
Maine
Pvt 4 Co 151 Depot Brigade
World War I
March 29 1896 July 2 1963

(R1#546)

ALICE M. TETREULT
wife of
JOSEPH E. MENARD
June 11, 1903 Mar. 7, 1989

(R1#547) Landry Monument
LANDRY
EVA A. LANDRY
1915 - 1963
daughter
JEANNE A.
1943 - 1974
My Jesus mercy

(R1#548) St. Onge Monument
East Face:
ST. ONGE
West Face:
LOUIS PHILIP ST. ONGE
1895 1974
his wife
JOSEPHINE M. LABEL
1894 - 1970

(R1#550) Marquis Monument
MARQUIS
JOSEPH F. NANCY L.
Nov. 23, 1931 Dec. 28, 1929
Nov. 16, 1965

Marker Stone:
(R1#549) LOUIS P St. ONGE
Bugler US Army
June 2 1895 Aug 16 1974

Marker: U.S. Veteran

(R1#551) GERARD ARCHIL BISSON
Maine
S1 USNR
World War II
Feb 10 1922 Feb 3 1966

(R1#552) RITA M. POULIN
July 27, 1923 - Dec. 22, 1964
wife of
GERARD A. BISSON

(R1#553) Coulombe Monument
COULOMBE
1892 JOSEPH E. 1964
son epouse
1895 LUCIA P. 1983
Salve regina

Marker Stones:
(R1#554) JOSEPH E COULOMBE
Maine
Cpl Btry A 1 Prov Dev Brig
World War I
Nov 15 1892 Jan 20 1964

Marker: U.S. Veteran

(R1#555) LUCIA PARADIS
epouse de
JOSEPH E COULOMBE
9 Oct 1895 Feb 1 1983

(R1#556) Huppe Monument
East Face:

HUPPE
Jesus Marie Joseph

West Face:
1909 ARMAND H. HUPPE 1994
son epouse
1911 DOROTHY J. LABEL 1964

(R1#557) Garand Monument
GARAND
1906 WILLIAM A. 1963
his wife
1912 ALICE PIUZE 2007
Say a Hail Mary

(R1#558) Bolduc Monument

East Face:

BOLDUC
Jesus Mary Joseph

West Face:

BOLDUC
JOSEPH J. BOLDUC
July 12, 1899 Oct. 20, 1978
his wife
JEANNE GIRARD
Dec. 27, 1901 June 14, 1981

(R1#559) Dechene Monument

DECHENE

RENE P.

1896 - 1966

his wife

CLARA M.

1904 - 1996

Jesus Mary Joseph

(R1#560)

PLOURDE

ALPHEE J. Married MARTHA R.
1902 - 1966 June 30, 1930 1903 - 1994

(R1#561) Coulombe Monument

COULOMBE

ALFRED J. COULOMBE

1902 - 1981

his wife

JULIA C. PINNETTE

1899 - 1996

(R1#562) Skaling Monument

SKALING

WILFRED F.

1892 - 1970

ANNE M.

1892 - 1966

The hours part us, but they bring us together again

Marker Stones:

(R1#563) WILFRED

(R1#564) ANNE

(R1#565) Miller Monument

MILLER

1890 WILLIAM J. 1964

his wife

1900 EXILDA M. 1978

In loving memory

(R1#566) Desjardins Monument

DESJARDINS

JOSEPH T. DESJARDINS

1889 - 1974

his wife

LOTTIE C. CHARRON

1894 - 1969

In loving memory

(R1#567) Lamarre Monument

LAMARRE

1917 ROGER J. LAMARRE 1966

his wife

1917 VIRGINIA F. SAWYER 1999

Earth has no sorrow that heaven cannot heal

(R1#569) Raymond Monument

RAYMOND

1897 EDWARD J. RAYMOND 1986

his wife

1892 CECILE D. PELLETIER 1984

(R1#568) Raymond Monument

RAYMOND

Father Mother

WILFRED L. MABEL M.

1902 - 1972 1906 - 1986

(R1#570) Raymond Monument
RAYMOND
1904 GALDYS 1985 1903 PATRICK 1966

(R1#571) Richard Monument
RICHARD
AURELIE J. PHILLIP
1900 - 1978 1898 - 1966

(R1#572) Masse Monument
MASSE
ROLAND F. MASSE
1914 - 1966
his wife
MARIE F. TREMBLAY
1924 -

Marker Stones:
(R1#573) MARIE F. TREMBLAY
Mar. 1, 1924
wife of
ROLAND F. MASSE

Marker: U.S. Veteran

(R1#574) ROLAND F. MASSE
Maine
S Sgt 491 Reinf Co
World War II
Aug 23 1914 March 16 1960

(R1#575) St. Pierre Monument
ST. PIERRE
AUGUSTE ST. PIERRE
13 Dec. 1896 - 10 Janv. 1960
son epouse
ALICE GUINARD
5 Jan. 1901 - 6 Avril 1965
Priez pour nous

Marker Stone:
(R1#576) AUGUST St PIERRE
Maine
Pvt 7 Co Coast Arty
World War I
Dec 13 1896 Jan 10 1960

Marker: U.S. Veteran

(R1#577) Fortin Monument
IHS
FORTIN

Marker Stone:
(R1#578) FULGENCE C FORTIN
Maine
Tec 5 2 Inf School Trp
World War II BSM
March 22 1919 Dec 1 1959

(R1#579) LeBlanc Monument

LeBLANC

Please
say a
Hail Mary

Husband
ALBERT R. LeBLANC
Sept. 22, 1910
Nov. 22, 1959

Wife
HELEN A. BEAUREGARD
July 8, 1906
May 31, 1973

(R1#580) Emmons Monument
EMMONS
LOUIS E. EMMONS
1887 - 1942
FLORENCE F. his wife
1897 - 1976

(R1#581) Arsenault Monument
ARSENAULT
1906 JOSEPH E. 1960
1909 BEATRICE M. 1991

(R1#582) Cote Monument
Our Father who art in heaven
COTE
EUGENE D. COTE
World War I, D.A.V.
Dec. 23, 1888 - July 23, 1972
his wife
MARGARET E. CARTER
Feb. 14, 1893 - Apr. 4, 1968
In loving memory

(R1#583) Pellegrini Monument
PELLEGRINI
Marker Stone:
(R1#584) ALDO J. PELLEGRINI
1886 - 1958
his wife
ROSE DUMAIS
1887 - 1960

(R1#585) Beaulieu Monument
BEAULIEU
Father Mother
HENRY YVONNE
BEAULIEU LeCLERC
Oct. 9, 1901 Jan. 18, 1906
May 17, 1961 Mar. 12, 1992
Say a Hail Mary

(R1#586) Thompson Monument
THOMPSON
Husband Wife
PIERRE J. MARGUERITE M.
Oct. 25, 1887 Feb. 28, 1888
Mar. 19, 1961 Sept. 25, 1974
"Say us a Hail Mary"

(R1#587) Frost Monument
FROST
RALPH H.
1884 - 1959
JULIA M. his wife
1883 - 1951

Marker Stone:
(R1#588) DOROTHY EDNA FROST
December 16, 1907
January 14, 2007

(R1#589) WILLIAM W.
FRENIER
1893 - 1950

(R1#590) JOSEPH D. DRAPEAU
1910 - 1947

(R1#591) EUGENE MITCHELL
1912 - 1946

(R1#592) Messier Monument

East Face:

MESSIER

Say a Hail Mary for us

West Face:

LUDGER M. MESSIER

Mar. 31, 1901 - Sept. 10, 1961

his wife

YVONNE F. ST. PIERRE

Oct. 15, 1902 - Mar. 11, 1978

(R1#596) Gamache Monument

GAMACHE

1892 PHILIP A. 1966

his wife

1897 DELIA M. 1987

In loving memory

Marker: U.S. Veteran

Marker Stone:

(R1#597)

PHILIP A GAMACHE

Maine

Pvt Co M 74 Inf 12 Div

World War I

July 25 1892 Dec 4 1966

(R1#600)

WILFRID A GAMACHE

Maine

Y3 USNR

World War II

Aug 26 1926 Nov 14 1966

(R1#602)

SYLVIO A.

BERNIER

1907 - 1958

(R1#603)

VIRGINIA L. BERNIER

September 26, 1923

September 18, 2006

(R1#593) Lemieux Monument

LEMIEUX

Father

HENRY A.

Aug. 11, 1895

Apr. 2, 1962

Sacred heart of Jesus have mercy on

Mother

DINA M. DUBA

May 20, 1896

Oct. 31, 1974

Marker Stones:

(R1#594)

LEMIEUX

ALEXIS H. RUTH M.

Jan. 17, 1919 July 1, 1924

Nov. 24, 2001 Dec. 12, 1988

(R1#595)

In loving memory

JEANINE M. WELCH

Sept. 23, 1931

May 1, 1985

(R1#598)

JOSEPH A. MICHAU

March 9, 1893

August 16, 1967

(R1#599)

JEAN GAMACHE

1926 - 1955

(R1#601)

WILLIAM H

HUGHES

Maine

Cpl Btry C

703 AAA Gun Bn

September 7 1930

September 3 1956

Marker: U.S. Veteran

(R1#604)

THERESA PELLETIER

1927 - 1961

wife of

HENRY PELLETIER

(R1#605) Bernier Monument

BERNIER

Mere	Pere
HENRIETTE	WILFRED
FAVREAU	BERNIER
22 Mai 1891	8 Aout 1889
29 Sept. 1962	29 Juil. 1977

Vous qui passez priez pour nous

(R1#606) Bourassa Monument

BOURASSA

Husband	Wife
ALBERT S.	LYDIA
BOURASSA	HELIE
1882 - 1962	1885 - 1964

My Jesus mercy

(R1#607) Mulligan Monument

MULLIGAN

Marker: U.S. Veteran

Marker Stone:

(R1#608) LEONARD J MULLIGAN
 Maine
 Sea USNRF
 World War I
 Feb 2 1897 Aug 11 1962

(R1#609) YVONNE B.
 ROBINSON
 Mar. 22, 1912
 Oct. 16, 1968

(R1#610) PATRICK A.
 MICHAUD Jr.
 1904 1968

(R1#611) East Face:

TREPANIER

West Face:
 DAMIEN A. TREPANIER
 1901 - 1964

(R1#612) Michaud Monument

Que votre
 volonte soit faite
 MICHAUD

1896	ADOLPHE MICHAUD	1963
	son epouse	
1903	ROSE ALMA BELANGER	1991

Marker Stone:

(R1#613) ADOLPHE MICHAUD
 Maine
 Pvt 10 Co Coast Artillery
 World War I
 Feb 14 1896 April 1 1963

Marker: U.S. Veteran

(R1#614) Deschene Monument

DESCHENE

My Jesus mercy

1898	JOHN B. DESCHENE	1963
	his wife	
1896	ANSELMIE RICHARD	1979

(R1#615) Lavoie Monument

LAVOIE

XAVIER F. LAVOIE

1892 - 1972

son epouse

SYLVIA VERMETTE

1891 - 1963

Salve regina

(R1#616) ULRIC W. DAGENAIS
1900 - 1963
his wife
RITA A. PROVOST
1903 -

(R1#617) COULOMBE
ADELARD A. DORILDA
1907 - 2006 1913 - 2000

(R1#618) YVONNE COULOMBE ARRIS
May 20, 1934 Oct. 6, 1954 GRANVILLE A.
Oct. 17, 1935

(Two interlocking rings through middle date.)

(R1#619) Theberge Monument
East Face:

THEBERGE

West Face:

1907 PHILIP J. THEBERGE 1963
1910 NATALIA KIDDER wife 1997

(R1#620) Guerette Monument

GUERETTE

1881 JOHN B. GUERETTE 196
son epouse

1880 PAMELA THIBEAULT

(R1#621) PHILIP DISTEFANO
1895 - 1964
VIOLA WING
1912 - 1983

(R1#622) Paquette Monument

PAQUETTE

ADELARD J. PAQUETTE

1905 - 1965

his wife

GERTRUDE A. GLIDDEN

1915 - 1977

In loving memory

(R1#623) THERESA M.
MacKENZIE
Aug 21, 1940
Mar. 26, 1981

ST. JOHN THE BAPTIST CEMETERY - Range Layout

RANGE #2

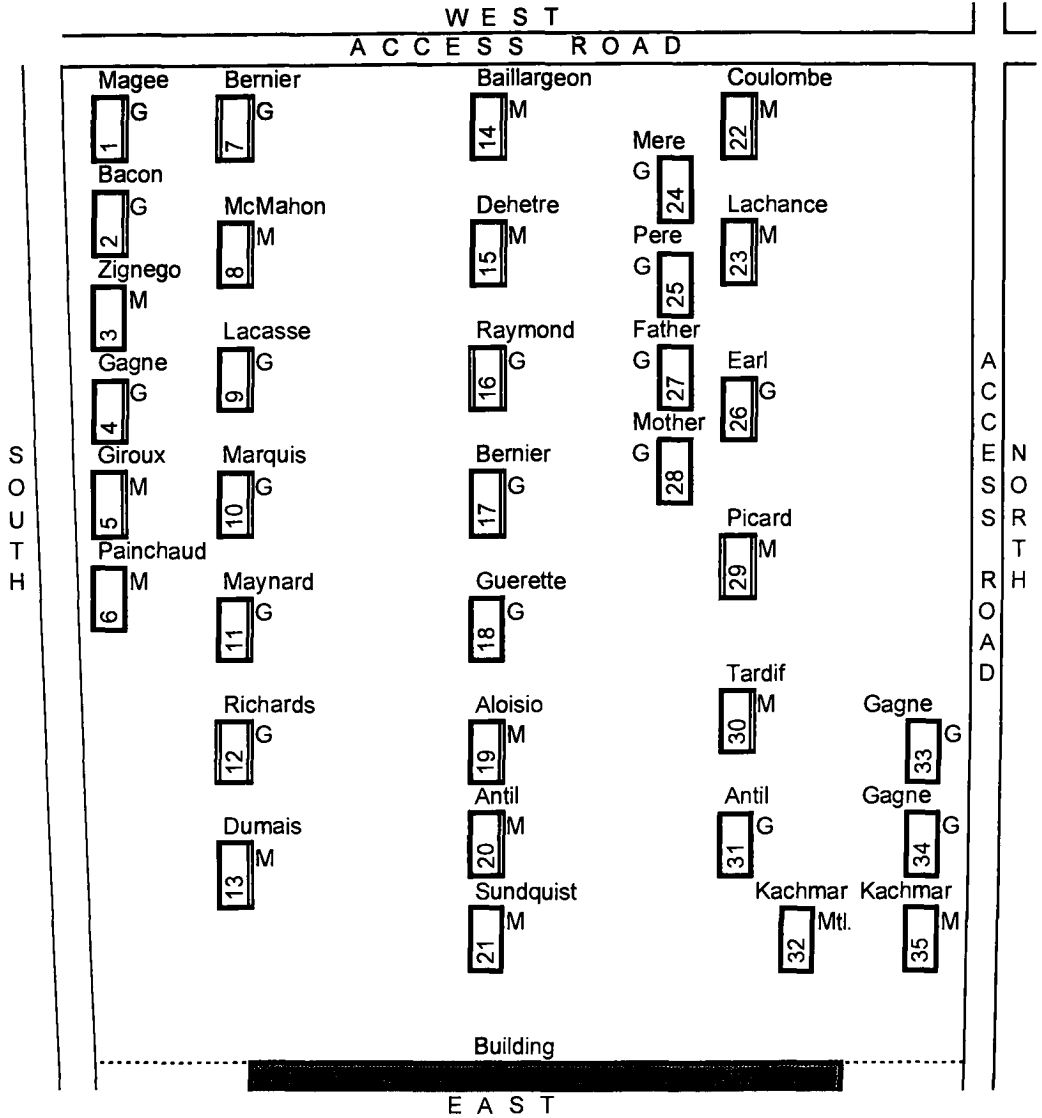

RANGE #2

(R2#1) WILLIAM J.
MAGEE
May 13, 1913
Sept. 1, 1956
He giveth
his beloved sleep

Marker: U.S. Veteran

(R2#2) ROSE E. BACON
1908 - 1955

(R2#3) ZIGNEGO
CHARLES
1874 - 1952
AMELIA his wife
1886 - 1954

(R2#4) NAPOLEON
GAGNE, Jr.
1903 - 1951

(R2#5) OBELINE M. GIROUX
1879 - 1951

(R2#6) PAINCHAUD
1921 FLORENCE 1948
1943 RICHARD 1951

(R2#7) North Face:
BERNIER

South Face:
JOSEPH ARTHUR BERNIE
1881 - 1956
son epouse
ELMIRE TARDIFF
1879 - 1969

(R2#8) McMAHON
JOHN P.
Mar. 21, 1883 - Apr. 2, 1950
his wife
MARILDA Z.
Aug. 12, 1883 - Mar. 26, 1973

(R2#10) MARQUIS
LUDGER L. MARQUIS
1893 - 1961
his wife
EVA WILSON
1894 - 1950

(R2#9) Sainte Marie
priez pour nous
LACASSE
JOSEPH A. LACASSE
1886 - 1950
son epouse
LEDA CORMIER
1887 - 1977

(R2#11) MAYNARD
ROSE OSCAR
1891 - 1950 1887 - 1956

(R2#12) North Face:
RICHARDS

South Face:
THOMAS J.
1894 - 1950
AMELIA his wife
1897 - 19

(R2#15) JEAN B. DEHETRE
1892 - 1949
son epouse
MARIE A. PHILIPPON
1896 - 1983

(R2#17) BERNIER
1874 ERASE 1952
his wife
1875 AURELIE 1949

(R2#18) Y. GUERETTE
1918 - 1980

(R2#20) ARTHUR D.
1896 - 1947
son epouse
YVONNE
1896 - 1987
ANTIL

(R2#22) HERMENEGILDE
1857 - 1937
son epouse
DERIMENE CARON
1867 - 1959
LUCIA
1892 - 1963
COULOMBE

(R2#13) ALICE DUMAIS
1884 - 1950

(R2#14) ALFRED BAILLARGEON
1893 - 1959
ALIDA son epouse
1895 - 1949

(R2#16) North Face:
IHS
RAYMOND
South Face:
TELESPHORE RAYMOND
born May 9, 1885
died Nov. 28, 1963
his wife
LEA RAYMOND
born August 17, 1888
died March 30, 1949

(R2#19) PETER V. ALOISIO
1905 - 1948

(R2#21) MARY L.
SUNDQUIST
1891 - 1949

(R2#23) Lachance Monument
ANTOINE J.
1896 - 1948
AGATHE
1900 - 1975
LACHANCE

Marker Stones:
(R2#24) MERE (R2#25) PERE

(R2#26) Earl Monument

EARL
1869 WILLIAM T. 1959
his wife
1874 JULIE D. 1947

Marker Stones:

(R2#27)

Our beloved
husband and father

(R2#28)

Our beloved
wife and mother

(R2#29) North Face:

PICARD
South Face:
LOUIS B.
1866 - 1950
ELMIRE
1866 - 1948

(R2#30)

TARDIF
ARSENE L.
1884 - 1948
epouse
JOSEPHINE
1885 - 1968

(R2#31)

ARTHUR DELPHIS ANTIL
Massachusetts
MA3 USNRF
World War I
Oct 9 1896 Nov 16 1947

(R2#32)

Boy KACHMAR
Nov. 1970

(R2#33)

JOSEPHINE D. GAGNE
1876 - 1952

(R2#34)

NAPOLEON GAGNE
Pvt 1 Maine Inf
Sp Am War
Aug 15 1878 Oct 31 1947

(R2#35)

JOSEPH A KACHMAR
Maine
Pvt 346 Infantry 87 Div
World War II
Jan 27 1919 Jan 26 1945

ST. JOHN THE BAPTIST CEMETERY - Range Layout

RANGE #3
Map #1

W E S T

S O U T H

A C C E S S O R Y
R O A D

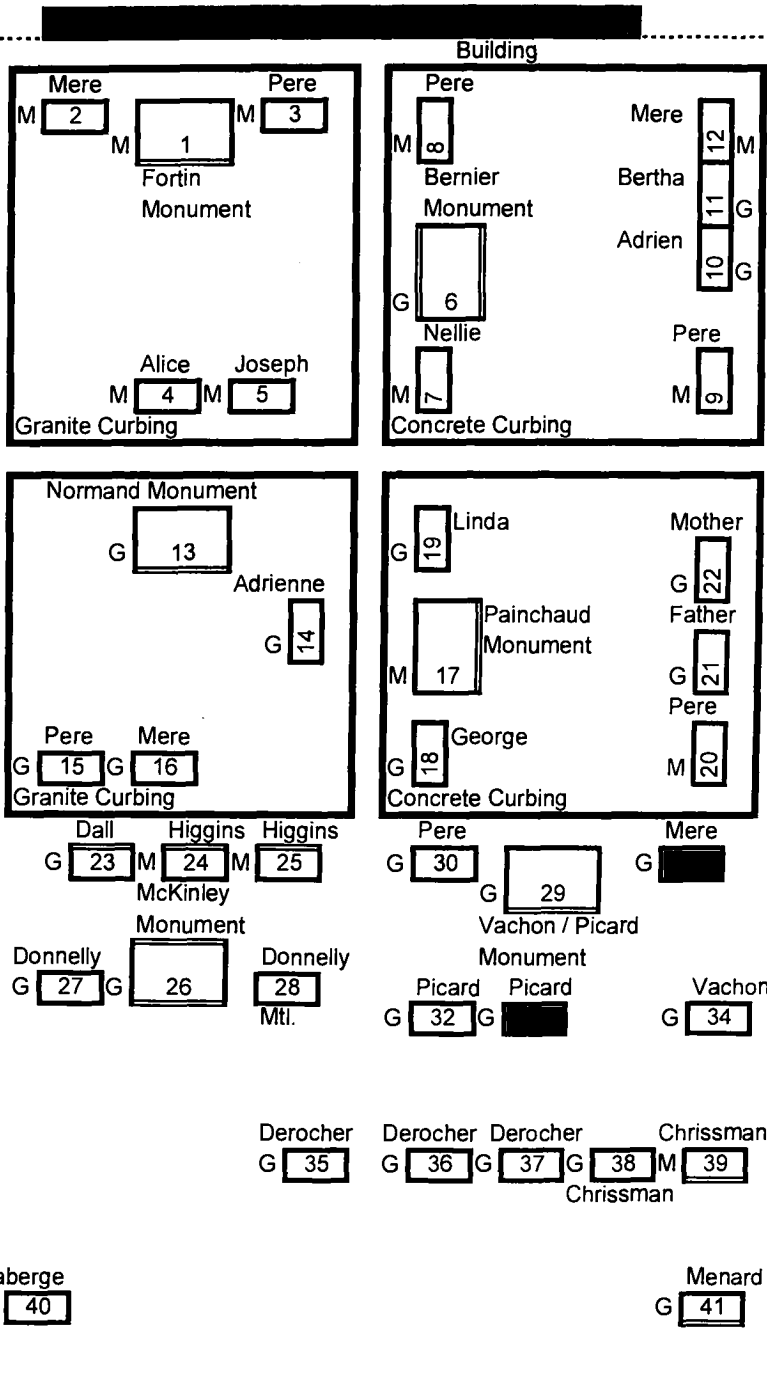

E A S T

ST. JOHN THE BAPTIST CEMETERY - Range Layout

RANGE #3
Map #2

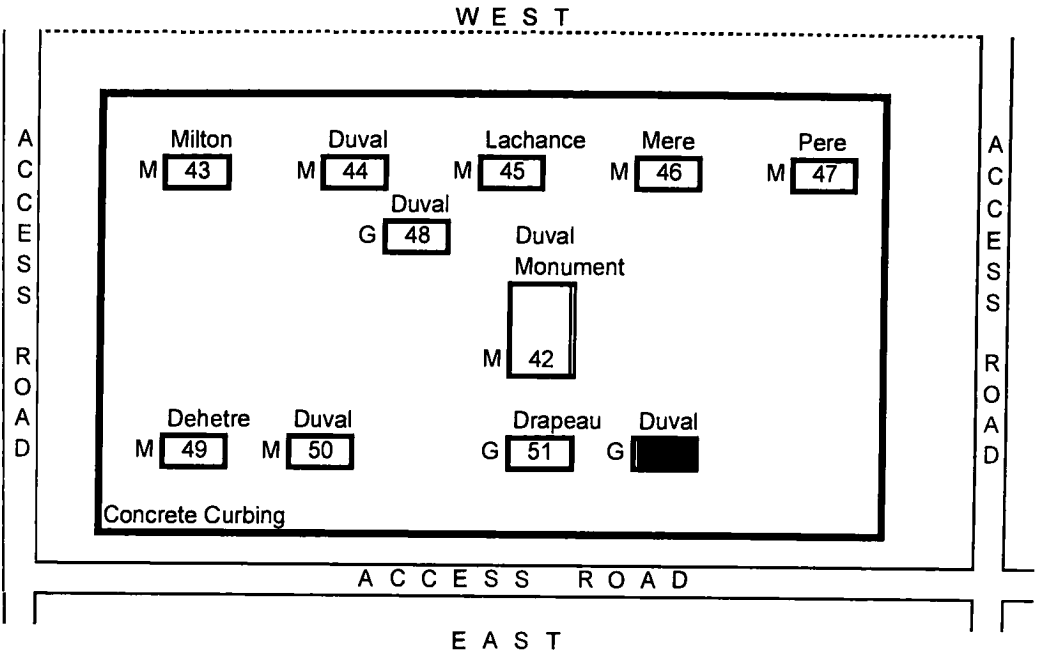

RANGE #3

(R3#1) Fortin Monument

FORTIN
THEODORE FORTIN
1857 - 1930
son epouse
DELPHINE POITRAS
1867 - 1941

Marker Stones:

(R3#2) MERE

(R3#3) PERE

(R3#4) ALICE SAINDON
epouse de
JOSEPH T. FORTIN
1887 - 1953

(R3#5) JOSEPH T. FORTIN
epouse de
ALICE SAINDON
1888 - 1962

(R3#6) Bernier Monument

North Face:

BERNIER
1907 ADRIEN E. BERNIER 1974
son epouse
1909 BERTHA E. TURCOTTE 1976
Jesus Marie Joseph

Marker Stones:

(R3#7) NELLIE

(R3#8) PERE

South Face:

BERNIER
1855 AMABLE BERNIER Sr. 1928
son epouse
1859 PHILOMENE LEVESQUE 1950
fils
1877 AMABLE BERNIER 1965
son epouse
1880 NELLIE BERNIER 1951

(R3#9) Pere
AMABLE BERNIER
1877 - 1965

(R3#10) ADRIEN E.

(R3#11) BERTHA E.

(R3#12) MERE

(R3#13) Normand Monument

NORMAND

Marker Stones:

(R3#14) ADRIENNE NORMAND
Feb. 19, 1906
July 10, 1981

(R3#15) PERE

(R3#16) MERE

(R3#17) Painchaud Monument

NUMA PAINCHAUD
1843 - 1929
epoux de
CLAUDIA GUIMOND

Marker Stones:

(R3#18) GEORGE G.
PAINCHAUD
1947 -

Marker Stones Cont'd.:

(R3#19)

LINDA R.
PAINCHAUD
1948 -

(R3#20)

Pere
JEAN B. PAINCHAUD
epoux d' ADELE CARON
1877 - 1935

(R3#21)

Father
LEO A.
PAINCHAUD
1902 - 1984

(R3#22)

Mother
JEANNETTE A.
PAINCHAUD
1912 - 2004

(R3#23)

DALL
MAMIE GEORGE
July 12, 1889 Jan. 19, 1886
Aug. 18, 1983 Feb. 19, 1947

(R3#24)

JOEL F. HIGGINS
Co. 1
1 Maine Inf.
Sp. Am. War

Marker: U.S. Veteran

(R3#25)

LENA
wife of
JOEL F. HIGGINS
1875 - 1929

(R3#26) McKinley Monument

East Face:

McKINLEY

West Face:

PETER McKINLEY
1849 - 1934

(R3#27)

MARY C. DONNELLY
1897 - 1981

Marker: U.S. Veteran

(R3#28)

DANIEL J DONNELLY
Cpl US Army
World War II
Feb 25 1904 Oct 28 1989

(R3#29) Vachon / Picard Monument

IHS
VACHON
-
PICARD

Marker Stones:

(R3#30)

Pere
JOSEPH H. VACHON
1866 - 1949

(R3#31)

Mere
LUDIVINE VACHON
1874 - 1929

(R3#32)

EMERILDA PICARD
1892 - 1966

Marker Stones Cont'd.

(R3#33) AMEDEE L. PICARD
1892 - 1974

(R3#34) ALICE B. VACHON
1897 - 1946

(R3#35) LUCIENNE L. DEROCHER
May 7, 1913
August 18, 1995

(R3#36) YVONNE
DEROCHER
1904 - 1978

(R3#37) CHARLES W.
DEROCHER
1901 - 1971

(R3#38) ADELARD
CHRISMAN
1873 - 1956

(R3#39) JOSEPHINE
wife of
ADELARD J. CHRISMAN
1877 - 1929

(R3#40) OCTAVE E LABERGE
Maine
Pvt Co F 151 Depot Brig
World War I
April 5 1889 Oct 15 1969

(R3#41) JOHN MENARD
1889 - 1929

(R3#42) Duval Monument
IHS
DUVAL
GEORGE DUVAL
1866 - 1929
son epouse
LEONTINE DESJARDINS
1871 - 1959

Marker Stones:

(R3#43) JOHN F. MILTON
May 29, 1902
Dec. 8, 1953
Say a "Hail Mary"

(R3#44) ALFRED DUVAL
epoux de
VICTORIA LACHANCE
4 Juin 1896 8 Fev. 1972

(R3#45) VICTORIA LACHANCE
epouse de
ALFRED DUVAL
29 Juil. 1895 25 Mars 1959

(R3#46) MERE

(R3#48) DAVID ROLAND DUVAL
August 3, 1958
August 3, 1958

(R3#47) PERE

(R3#49) EVA M. DEHETRE
epouse de
WILFRED DUVAL

Marker Stones Cont'd.
(R3#50)

WILFRED J. DUVAL
epoux de
EVA M. DEHETRE
23 Fev. 1898 - 5 Mars 1995

(R3#51)

JEANNE A. DRAPEAU
epouse de
ADOLPHE J. DUVAL
21 Aout 1908 - 29 Oct. 2000

(R3#52)

ADOLPHE J. DUVAL
epoux de
JEANNE A. DRAPEAU
15 Aout 1902 - 15 Avril 1997

ST. JOHN THE BAPTIST CEMETERY - Range Layout

RANGE #4
Map #1

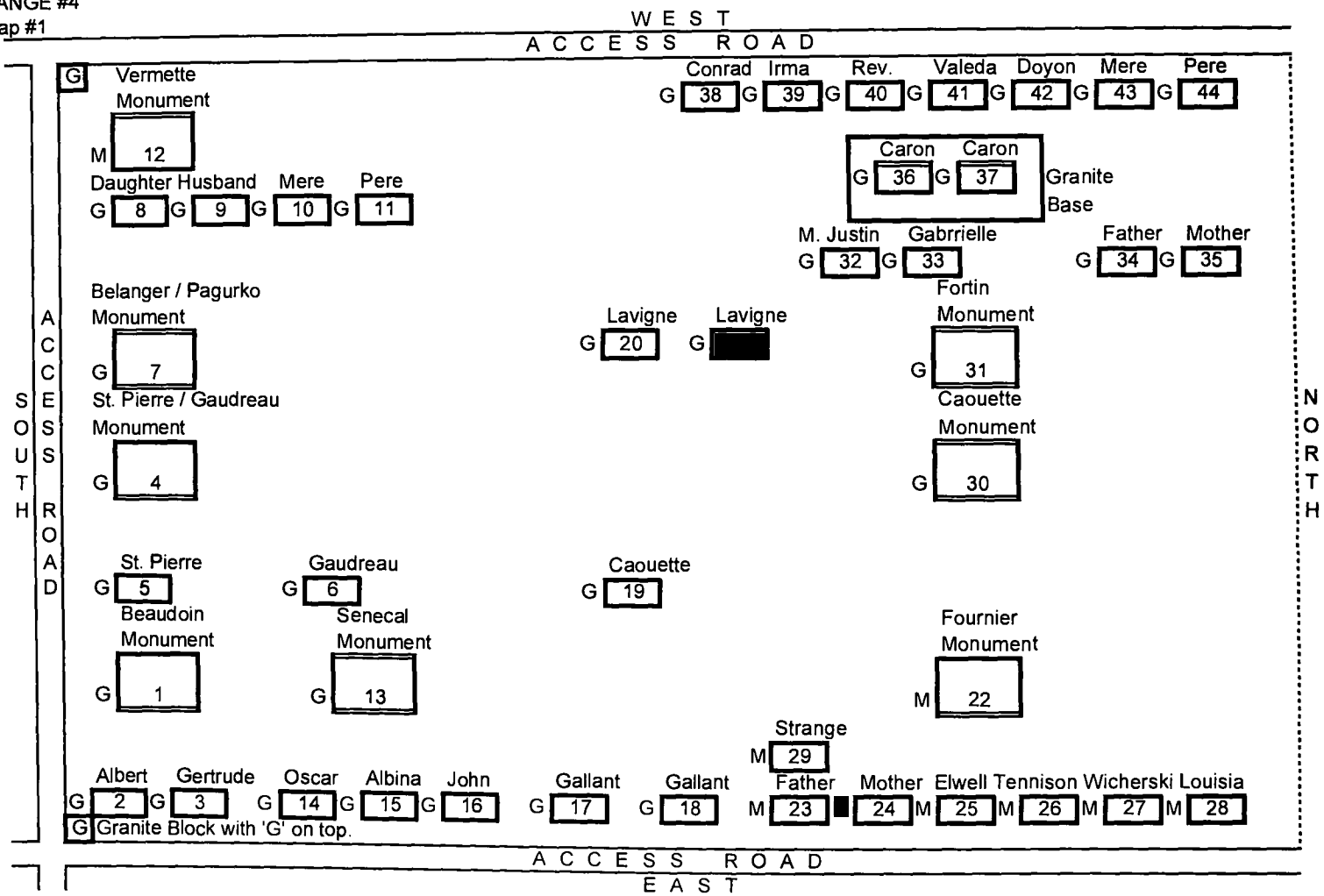

ST. JOHN THE BAPTIST CEMETERY - Range Layout

RANGE #4
Map #2

W E S T
A C C E S S R O A D

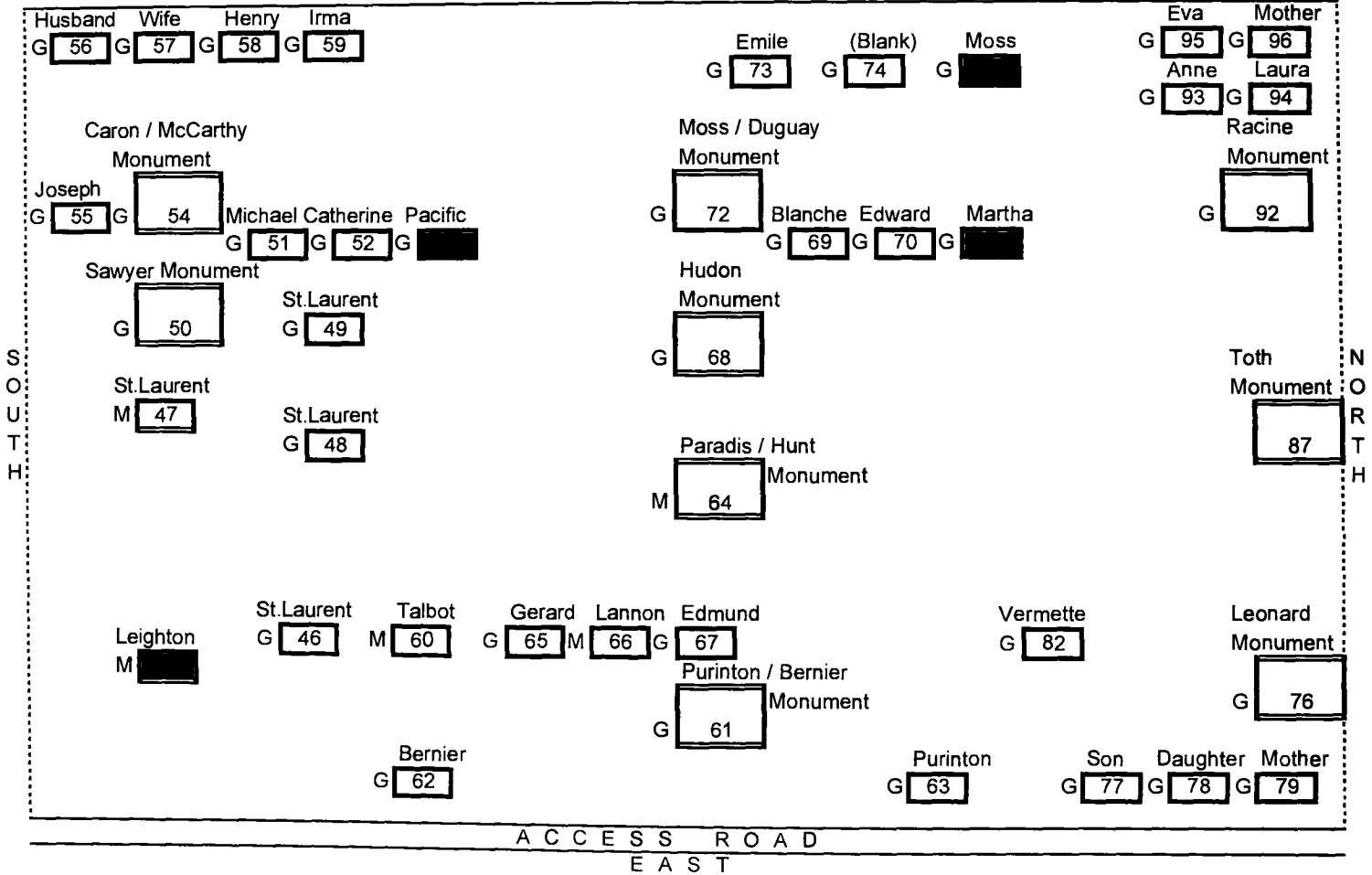

A C C E S S R O A D
E A S T

S
O
U
T
H

N
O
R
T
H

ST. JOHN THE BAPTIST CEMETERY - Rings Layout

RANGE #4
Map #3

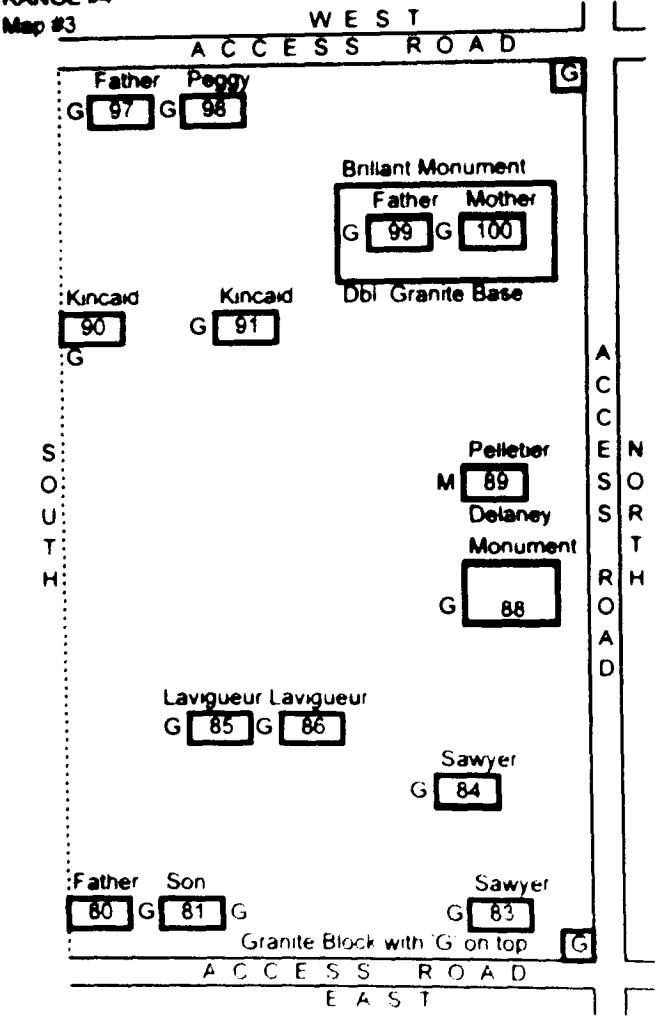

RANGE #4

(R4#1) Beaudoin Monument

BEAUDOIN

ALBERT ROBERT

May 13, 1922

February 23, 2004

GERTRUDE SENECAL

October 15, 1922

September 19, 1992

Marker Stones:

(R4#2) ALBERT R. BEAUDOIN

1922 - 2004

(R4#3) GERTRUDE S. BEAUDOIN

1922 - 1992

(R4#4) St. Pierre / Gaudreau Monument

GEORGE J. ST. PIERRE

1918 - 2001

VELMA D. ST. PIERRE

1922 - 2005

JEANINE OUELLETTE

1943

ELZEAR A. GAUDREAU

1893 - 1960

LOUISE M. GAUDREAU

1900 - 1960

AIME V. OUELLETTE

1920 - 1944

Marker: U.S. Veteran

Marker Stones:

(R4#5) GEORGE J ST PIERRE

US Army
World War II
1918 2001

(R4#6) ELZEAR A. GAUDREAU

Mar. 16, 1893 - Nov. 15, 1960
his wife
LOUISE BERGERON
Aug. 1, 1901 - Apr. 11, 1960

(R4#7) Belanger / Pagurko Monument

West Face:

BELANGER

PAGURKO

Jesus ayez pitie de nous

East Face:

ELZEAR BELANGER

17 Juil. 1876 - 12 Mars 1952

son epouse

AMANDA COULOMBE

6 Juin 1885 - 29 Juil. 1960

JOSEPH J. PAGURKO

28 Sept. 1910 - 2 Dec. 2004

spouse

SOPHIE BELANGER

31 Aug. 1912 - 31 Mar. 2000

Marker Stones:

(R4#8) Daughter

SOPHIE

(R4#9) Husband

JOSEPH

(R4#10) Mere

AMANDA

(R4#11) Pere

ELZEAR

(R4#12) Vermette Monument

JEFFREY T. VERMETTE
1888 - 1946
SOPHIE A. VERMETTE
1888 - 1978

(R4#13) Senecal Monument

East Face:

S / Sgt. JEAN P.
SENECAL
1921 - 1944

Marker: U.S. Veteran

West Face:

OSCAR A. SENECAL
Jan. 29, 1898 - Jan. 23, 1968
his wife
ALBINA DIONNE
Sept. 13, 1898 - Nov. 7, 1950

Marker Stones:

(R4#14) Our Father
OSCAR A. SENECAL
1898 - 1968

(R4#15) Our Mother
ALBINA SENECAL
1898 - 1950

(R4#16) JOHN P. SENECAL
1921 - 1944

(R4#17) FELIX A GALLANT
US Army
Jun 1 1917 Aug 14 1994

(R4#18) Beloved Mother
REGINA M. GALLANT
October 1, 1918
May 13, 2004

(R4#19) EDWARD J CAOQUETTE
Pvt US Army
World War II
1915 1976

(R4#20) WOODROW J LAVIGNE
US Navy
World War II
Dec 6 1917 Feb 17 1989

(R4#21) EMILIEENNE M LAVIGNE
wife of
WOODROW J. LAVIGNE
Nov. 1, 1915 Feb. 25, 1992

(R4#22) Fournier Monument
JOSEPH P. A. FOURNIER
1895 - 1962
his wife
LOUISIA A. FOURNIER
1894 - 1942

Marker Stones:

(R4#23) FATHER

(R4#24) MOTHER

(R4#25) Our son
KENNETH LEROY ELWELL
July 28, 1947
Sept. 15, 1947

(R4#26) ALFRED NEIL TENNESON Jr.
Aug. 28, 1948 age 1 day
MARY TENNESON
July 18, 1950 age 1 day

(R4#27) EVA WICHERSKI
1922 - 1953

(R4#28) LOUISIA E. FOURNIER
1915 - 1955

(R4#29) DEBORAH LYNN
STRANGE
Aug. 9, 1967

(R4#30) Caouette Monument

East Face:

CAOQUETTE

West Face:

Aug. 20, 1915 EDWARD J. CAOQUETTE May 29, 1976
Dec. 16, 1921 JEANNE B. his wife

(R4#31) Fortin Monument

West Face:

Thy will be done
FORTIN

East Face:

June 25, 1884 JOSEPH R. FORTIN May 16, 1984
son epouse
Nov. 13, 1889 ALICE MENARD Dec. 4, 1956

Marker Stones:

(R4#32) M. JUSTIN
FORTIN
1921 - 1993

(R4#33) GABRIELLE P.
FORTIN
1919 - 1998

(R4#34) FATHER

(R4#35) MOTHER

Caron Monument:

(R4#36)

CARON
CONRAD R.
1923
son epouse
IRMA BERNIER
1914 - 1989

(R4#37)

CARON
WILFRID A.
1880 - 1948
son epouse
M. ROSE FORTIN
1884 - 1957

Marker Stones:

(R4#38)

CONRAD
1923 -

(R4#39)

IRMA
1914 - 1989

(R4#40)

Rev. GERALD L. M. CARON, S.M.
born Jan. 31, 1927
Ordained June 17, 1954
died Nov. 12, 2001

(R4#41)

VALEDA E. CARON
born Oct. 14, 1907
died July 27, 2002

(R4#42)

ARMANDINE DOYON
1908 - 1982

(R4#43)

Mere
M. R. CARON

(R4#44)

Pere
W. A. CARON

(R4#45)

Mother
LENA M.
LEIGHTON
wife of
ARTHUR M. COX
July 18, 1878
Nov. 13, 1942

(R4#46)

ST. LAURENT
MATHILDA GEORGE
1906 - 1967 1903 - 1983

(R4#48)

ST. LAURENT
MATHILDA GEORGE
1906 - 1967 1903 - 1983

(R4#47)

THOMAS
1881 - 1949
MARIANNA
1881 - 1945
Leur fils
LUCIEN A.
1914 - 1953
PHILLIPPE
1904 - 1977
ST. LAURENT

(R4#49)

GEORGETTE ST. LAURENT
January 19, 1928
February 14, 1995

(R4#50) Sawyer Monument

West Face:

SAWYER

East Face:

PACIFIC A. SAWYER
Oct. 22, 1900 Mar. 7, 1972
KATHERINE JEAN SAWYER
May 23, 1902 May 20, 1969
MICHAEL A. SAWYER
Feb. 3, 1938 May 31, 1958

Marker: U.S. Veteran

Marker Stones:

(R4#51) MICHAEL ANTHONY SAWYER
Maine

A2C 464 Trp Carr WG AF
Feb 3 1938 May 31 1958

(R4#52) CATHERINE JEAN SAWYER
May 23 1902 May 20 1969

(R4#53) PACIFIC A SAWYER
Oct 22 1900 Mar 7 1972

(R4#54) Caron / McCarthy Monument

West Face:

McCARTHY

CARON

Marker Stones:

(R4#55) JOSEPH BERTRAND CARON

East Face:

CARON

McCARTHY

J. BERTRAND CARON

HENRY McCARTHY

1914 - 2007

1906 - 1983

his wife

his wife

PATRICIA T. BERNIER

IRMA CARON

(R4#56)

1917 - 1996

1906 - 2005

PFC US Army
World War II
Dec 11 1914 Apr 24 2007
Bronze Star Medal

Husband
J. BERTRAND
1914 - 2007

(R4#57)

Wife
PATRICIA
1917 - 1996

(R4#60) DELINA TALBOT
1918 - 1943

(R4#58)

HENRY

(R4#61) Purinton / Bernier Monument

East Face:

PURINTON
BERNIER

(R4#59)

IRMA

West Face:

1918 ALICE M. PURINTON 1996

1932 EVARISTE O. BERNIER 1997

his wife

1932 STELLA M. PURINTON 2005

Marker Stone:

(R4#62) EVARISTE O BERNIER
Sgt US Marine Corps
Korea
Jun 2 1932 May 2 1997

Marker: U.S. Veteran

(R4#63)

ALICE M. PURINTON
Mar, 20, 1918 Dec. 17, 1996

(R4#64) Paradis / Hunt Monument

East Face:

PARADIS

West Face:

HUNT - PARADIS

1921 GERARD F. PARADIS 1975
his wife

1918 DELINA TALBOT 1943

1975 LANNON S. G. HUNT 1976

1954 EDMUND G. PARADIS 1977

Marker: U.S. Veteran

Marker Stones:

(R4#65)

GERARD F PARADIS

PFC US Army

World War II

Mar. 19, 1921 Oct. 2, 1975

(R4#66)

LANNON SCOTT

GERARD HUNT

Nov. 27, 1975 Jan. 19, 1976

son of

DAVID & FAYE

(R4#67) EDMUND GREGORY PARADIS

Nov. 19, 1954 - Jan. 3, 1977

(R4#68) Hudon Monument

East Face:

HUDON

West Face:

HUDON

Marker Stones:

(R4#69)

BLANCHE HUDON

Aug. 4, 1904 Feb. 14, 1999

wife of

EDWARD G. HUDON

Marker: U.S. Veteran

(R4#70) EDWARD G HUDON

S Sgt US Army Air Corps

World War II

Jan 24 1915 Sep 19 1994

(R4#71) MARTHA L. HUDON

March 23, 1891

Feb. 21, 1972

(R4#72) Moss / Duguay Monument

MOSS

DUGUAY

Marker: U.S. Veteran

Marker Stones:

(R4#73) EMILE J. DUGUAY

PFC US Army

World War I

Oct 6 1898 Dec 22 1985

(R4#74) (Blank)

(R4#75)

WYNN THOMAS MOSS

California

S. Sgt. 1 Marines 1 Mar. Div.

Korean War

Jan. 27, 1923 Sept. 22, 1950

(R4#76) Leonard Monument

East Face:

LEONARD

West Face:

July 13, 1881 GEORGE W. LEONARD Mar. 19, 1971

Mar. 29, 1891 MILDRED HUNT his wife July 31, 1969

their children

Sept. 16, 1917 BARBARA M.

Apr. 12, 1919 MARTIN A. Sept. 19, 1999

Oct. 28, 1920 MARY H. Apr. 20, 1948

Sept. 14, 1922 JOSEPH D. July 8, 2004

Mar. 17, 1925 DONALD H. Oct. 12, 2002

Oct. 23, 1926 RICHARD J. Oct. 23, 1941

Nov. 23, 1928 ROBERT F.

July 2, 1930 FRANCES M. Apr. 2, 2005

Marker Stones:

(R4#77)

Son

RICHARD J. LEONARD

Oct. 23, 1926

Sept. 4, 1941

(R4#78)

Daughter

MARY H. LEONARD

Oct. 28, 1920

Apr. 20, 1948

(R4#79)

Mother

MILDRED H. LEONARD

Mar. 29, 1891

July 31, 1969

(R4#80)

Father

GEORGE W. LEONARD

July 13, 1881

Mar. 19, 1971

(R4#81)

Son

MARTIN A. LEONARD

Apr. 12, 1919

Sept. 19, 1999

(R4#82)

VERMETTE

Husband

ALBERT N.

1894 - 1971

Wife

IDA A.

1901 - 1987

In God's care

(R4#83)

THOMAS C. SAWYER

1902 - 1942

(R4#84)

THOMAS C. SAWYER

1902 - 1942

May he rest in peace

(R4#85)

ALPHONSE LAVIGUEUR

1873 - 1954

(R4#86)

HERMINE LAVIGUEUR

1873 - 1943

(R4#87) Toth Monument

West Face:

TOTH

East Face:

MICHAEL S TOTH Sr.
Nov. 3, 1906 Apr. 25, 1994
MARY ANN TOTH his wife
Nov. 16, 1906 Apr. 20, 1996
their grandchildren
PATRICIA ANN TOTH
June 28, 1957 July 17, 1961
THERESA ANN KINCAID
Nov. 7, 1961 Nov. 8, 1961

(R4#88) Delaney Monument

East Face:

DELANEY

West Face:

JOHN M DELANEY
Sept. 21, 1876 - Jan. 10, 1942
DORAL his wife
Feb. 26, 1878 - Aug. 12, 1956
VIOLA L. daughter
Mar. 19, 1916 - Oct. 27, 1972
STELLA D. CARON
daughter
Nov. 16, 1909 - July 2, 1999

(R4#89) ELSIE STUBBS

PELLEHER

1912 - 1943

DONALD, son

1941 - 1945

(R4#90) MICHAEL O'NEIL KINCAID

June 26, 1966 - July 8, 1995

Sunshine

(R4#91) THERESA ANN KINCAID

PATRICIA ANN TOTH

Remembered

(R4#92) Racine Monument

RACINE

MICHEL J LEAV
1884 - 1942 1883 - 1964

Marker Stones

(R4#93) ANNE
1927 -

(R4#94) LAURA
1922 - 2007

(R4#95) EVA
1915 -

(R4#96) MOTHER

(R4#97) FATHER

(R4#98) PEGGY
1910 - 1994

Brilliant Monument

(R4#99) Father
ROMEO J.
1914 - 1958

(R4#100) Mother
ANTHAI
1915 - 1988

Base Stone

BRILLIANT

NORMAN G.
1941 - 1942

RANGE #5

Map #1

WEST
ACCESS ROAD

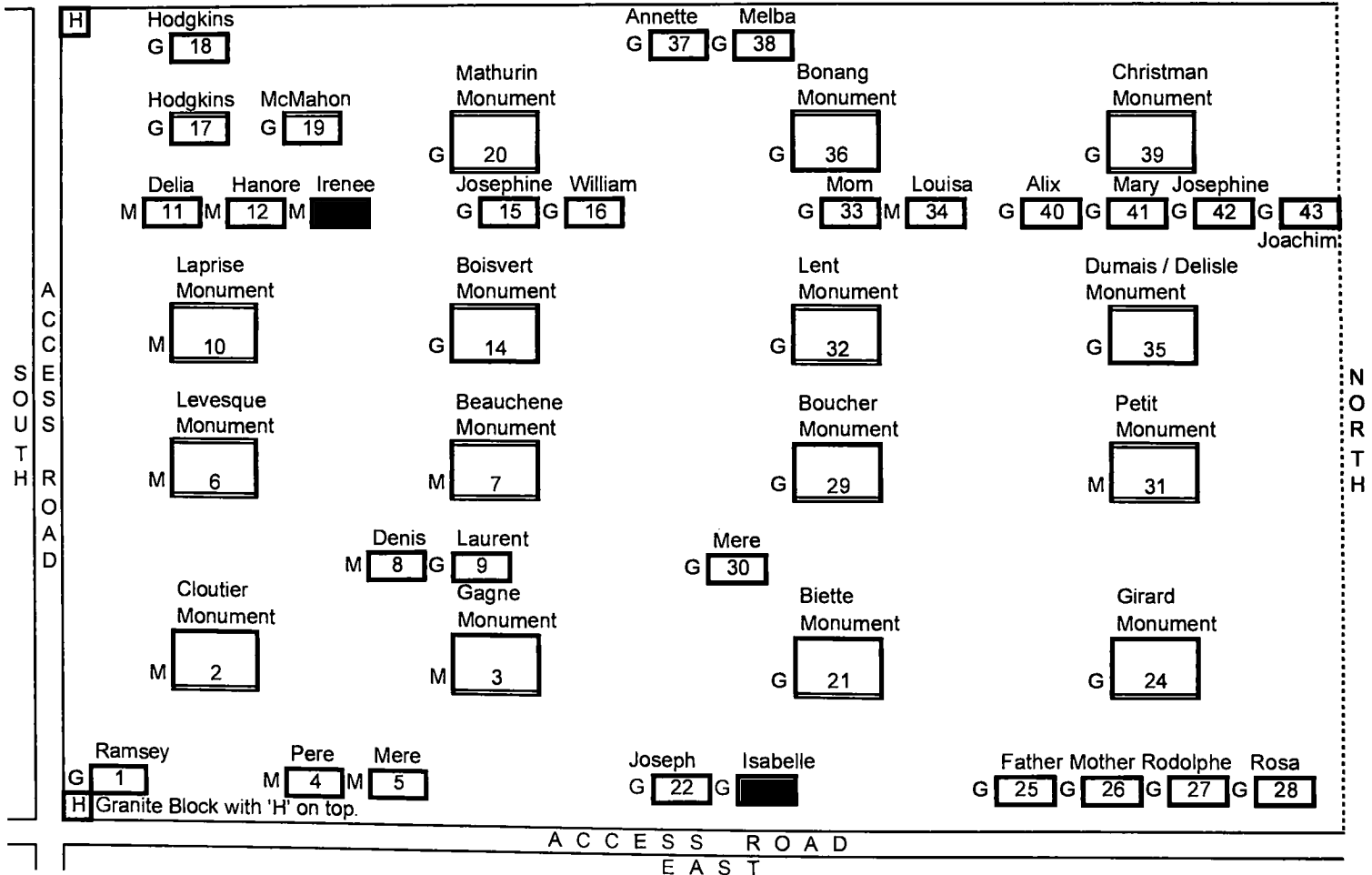

H

ACCESS ROAD

NORTH

EAST
ACCESS ROAD

Granite Block with 'H' on top.

RANGE #5
Map #2

W E S T

A C C E S S R O A D

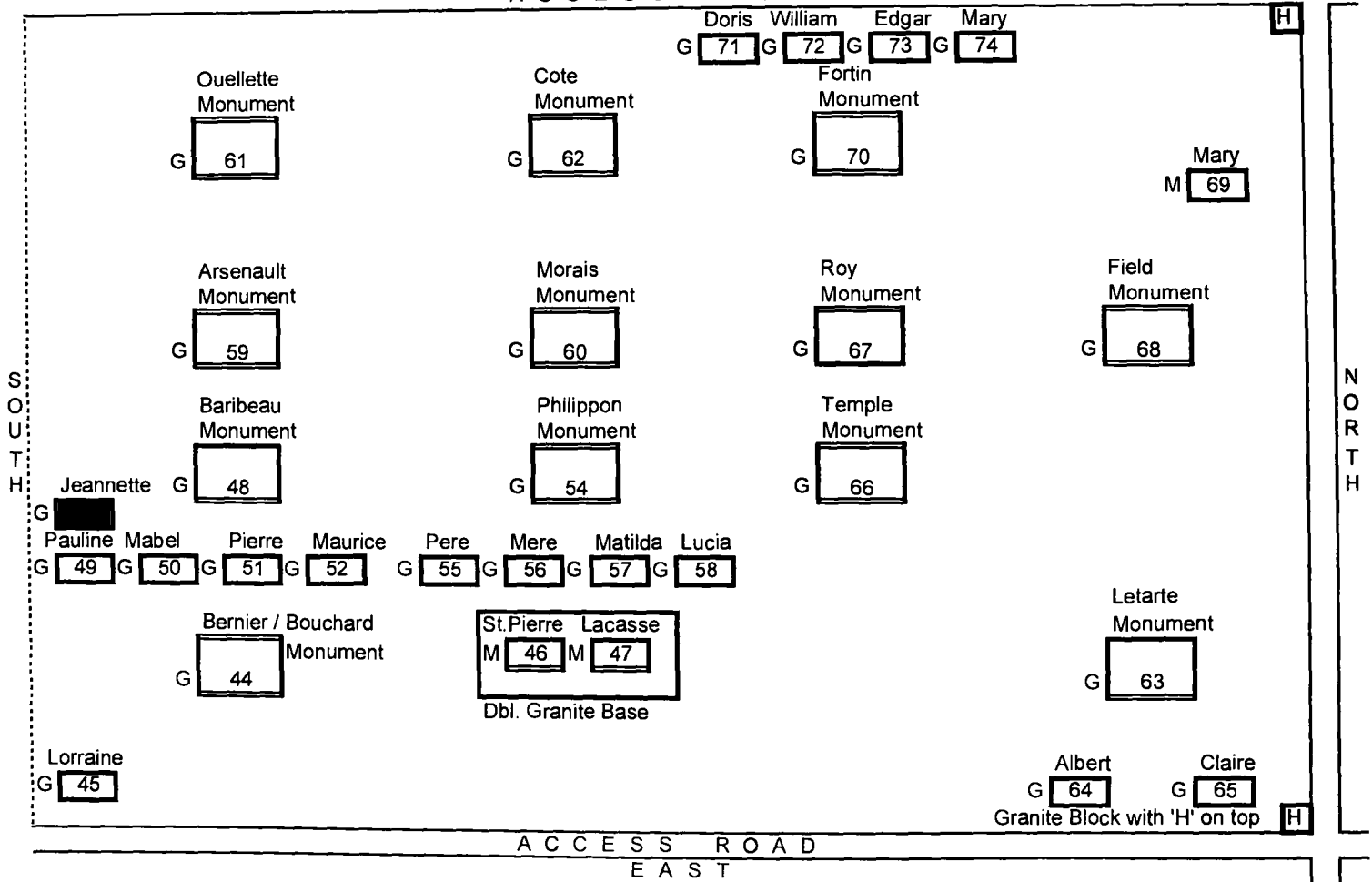

A C C E S S R O A D

E A S T

RANGE #5

(R5#1) MARY J. RAMSEY
Feb. 13, 1920
May 9, 1997

(R5#2) Cloutier Monument
DAMASE V. CLOUTIER
1891 - 1942
epouse
ROSE M. LABBE
1893 - 1957

(R5#3) Gagne Monument
JOSEPH L. GAGNE
1857 - 1942
son epouse
JOSEPHINE MONGEON
1861 - 1955
leur enfants
1882 ANTOINETTE 1976
1897 MARIE ANNE 1982

Marker Stones:
(R5#4) PERE
(R5#5) MERE

Marker: U.S. Veteran

(R5#7) Beauchene Monument

East Face:
BEAUCHENE

West Face:
1890 ADELARD BEAUCHENE 1977
1889 FEDORA L. BEAUCHENE 1983
1924 LAURENT J. BEAUCHENE 1963
1928 DENIS P. BEAUCHENE 1946

(R5#6) Levesque Monument
East Face:
CHARLES J.
1882 - 1960
son epouse
MARGUERITE
1890 - 1944
LEVESQUE

Marker Stones:
(R5#8) DENIS

West Face:
LOUIS A. LEVESQUE
1927 -
his wife
RITA H. GAMACHE
1926 - 1998

(R5#9) LAURENT J BEAUCHENE
Maine
T Sgt 456 Bomb Sq AAF
World War II AM & 2 OLC
Feb 12 1924 Sept 27 1963

(R5#10) Laprise Monument

West Face:
LAPRISE

Marker Stones:
(R5#11)

East Face:
HANORE F. LAPRISE
30 Aout 1890 - 8 Mai 1955
DELIA M. LAVOIE
18 Janvier 1887 - 28 Fevrier 1973
IRENEE H. LAPRISE
1 Janvier 1918 - 19 Fevrier 1946

Epouse
DELIA M. LAPRISE
18 Janvier 1887 - 28 Fevrier 1973

(R5#12) Epoux
HANORE F. LAPRISE
30 Aout 1890 8 Mai 1955

Marker Stones Cont'd.

(R5#13)

IRENEE H LAPRISE
Maine
PFC 409 Inf 103 Inf Div
World War II
Jan 1 1918 Feb 19 1946

(R5#14) Boisvert Monument

BOISVERT

Marker Stones:
(R5#15)

JOSEPHINE A.
1886 - 1981

(R5#16)

WILLIAM H.
1937 - 1946

(R5#17)

HODGKINS

DOUGLAS K.

JULIETTE P.

Jan. 12, 1929 - May 6, 1985 Mar. 14, 1930 - Dec. 13, 2007

(R5#18)

DOUGLAS K HODGKINS

Cpl US Army
Korea

Jan 12 1929 May 6 1985

(R5#19)

McMAHON

THOMAS F.

MARGARET K.

Dec. 21, 1887 - Dec. 29, 1943 Nov. 5, 1894 - May 17, 1981

(R5#20) Mathurin Monument

West Face:

MATHURIN

East Face:

MATHURIN

1883 IRENEE F. MATHURIN 1963

son epouse

1892 MARIE ANNE MAROIS 1986

RAYMOND MATHURIN 1999

his wife

CECILE EARL 1996

(R5#21) Biette Monument

BIETTE

epoux
OGLIBER J. BIETTE
22 Dec. 1892
13 Fev. 1959

epouse
ISABELLE MUTTY
24 Avril 1893
12 Nov. 1962

Marker: U.S. Veteran

Dites un je vous salue, Marie"

Marker Stones:

(R5#22)

JOSEPH O BIETTE
Maine
Pvt Co B 34 Machine Gun Bn
World War I
Dec 22 1892 Feb 13 1959

(R5#23)

ISABELLE H. BIETTE
April 24, 1893
Nov. 12, 1962

(R5#24) Girard Monument

East Face:

GIRARD

West Face:

JEAN BAPTISTE GIRARD
Nov. 27, 1876 - Aug. 13, 1950
his wife

MARGUERITE GIRARD
Sept. 19, 1879 - Feb. 28, 1942
their son

Marker: U.S. Veteran

Feb. 19, 1900 RODOLPHE GIRARD July 31, 1960

his wife

Mar. 16, 1901 ROSA LACHANCE GIRARD

Marker Stones:

(R5#25)

FATHER
1876 - 1950

(R5#26)

MOTHER
1879 - 1942

(R5#27)

RODOLPHE J B GIRARD
Maine
Sea US Navy
World War I
Feb 19 1900 July 31 1960

(R5#28)

ROSA LACHANCE GIRARD
Mar. 16, 1901 - Sept. 28, 1989
wife of
RODOLPHE GIRARD

(R5#29) Boucher Monument

BOUCHER

GERARD D.
Dec. 6, 1903
July 31, 1995

EVA L.
Aug. 4, 1912
Dec. 15, 2004

Marker Stone:

(R5#30)

MERE

(R5#31) Petit Monument

East Face:

PETIT
WILFRED J.
1874' - 1945
son epouse
ROSANNA BACHAND
1882 - 1969

West Face:

PETIT
ALPHONSE J.
1902 - 1963
son epouse
CELIOSE GUERETTE
1905 -

(R5#32) Lent Monument

West Face:

LENT

East Face:

JOHN E.
1904 - 1992
MARY D.
1910 - 1978

Marker Stones:

(R5#33)

MOM

(R5#34)

LOUISA M. LENT
1861 - 1947

(R5#35) Dumais / Delisle Monument

DUMAIS
DELISLE

(R5#36) Bonang Monument

Hail : Holy

Mary : Mary

BONANG

MARIE T. FREDERIC A.
1890 - 1966 1888 - 1968

Marker Stones:

(R5#37)

ANNETTE M. BONANG
1920 - 2005

(R5#38)

MELBA M. BONANG
1917 - 1996

(R5#39) Christman Monument

West Face:

CHRISTMAN

East Face:

1886 JOSEPH F. CHRISTMAN 1961
1886 JOSEPHINE W. his wife 1968
1911 ROBERT F. their son 1979

Marker Stones:

(R5#40)

ALIX D. DEROCHE
1921 - 1982

(R5#41)

MARY P.
1911 - 1970

(R5#42)

JOSEPHINE B.
1878 - 1964

(R5#43)

JOACHIM B.
1883 - 1946

(R5#44) Bernier / Bouchard Monument

East Face:

BERNIER
BOUCHARD

Marker Stone:
(R5#45)

LORRAINE H. BOUCHARD
December 21, 1932
December 15, 2004

West Face:

CYRIAS BERNIER
Aug. 11, 1869 - Feb. 5, 1942
his wife

CLOTHILDE DUBE
June 25, 1868 - Jan. 25, 1971
daughter

EVA O. BOUCHARD
Nov. 27, 1898 - June 26, 1989
husband

OVIDE L. BOUCHARD
Mar. 2, 1907 - June 26, 1995

(R5#46)

AUGUST ST. PIERRE
1886 - 1942
AURELIA H. ST. PIERRE
1890 - 1973

(R5#47)

ALPHONSE J. LACASSE
1902 - 1969
LUCILLE R. LACASSE
1914 - 1985

(R5#48) Baribeau Monument

BARIBEAU

Our Lady
of the
miraculous medal

Marker: Eagle symbol 1941 - 1945

Marker Stones:

(R5#49) PAULINE M.
BARIBEAU
1943 - 1944

(R5#50)

MABEL M. J. COULOMBE
BARIBEAU
1913 - 1971

(R5#51) PIERRE BARIBEAU
1905 - 1978
Shipyard veteran
during World War II

(R5#52)

MAURICE J. P.
BARIBEAU
1938 -

(R5#53)

JEANNETTE M.
BARIBEAU
1955 -

(R5#54) Philippon Monument

East Face:

PHILIPPON

Je suis la resurrection et la vie

West Face:

ODIAS PHILIPPON
1 Oct. 1871 - 10 Avr. 1944
son epouse

ALEXANDRINE ST. PIERRE
11 Nov. 1874 - 18 Oct. 1951

Marker Stones:
(R5#55)

Pere
ODIAS
1871 - 1944

(R5#56)

Mere
ALEXANDRINE
1874 - 1951

Marker Stones Cont'd.:

(R5#57) MATHILDA
PHILIPPON
1901 - 1973

(R5#58) LUCIA D.
PHILIPPON
1899 -

(R5#59) Arsenault Monument

West Face:

ARSENAULT

East Face:

ANDREW L. ARSENAULT
1880 - 1948
LEONA PERRY his wife
1888 - 1974
EDWARD J. ARSENAULT
1925 - 1947
RAYMOND J. ARSENAULT
1916 - 1977

(R5#60) Morais Monument

West Face:

MORAIS

East Face:

1894 OMER 1959
1888 ALEXINA 1950
1923 ISABELLE 1947
1906 LILLIAN 1959
1928 CAMILLIENNE 1999

(R5#61) Ouellette Monument

West Face:

OUELLETTE

East Face:

ANDRE OUELLETTE
25 Mars 1906 - 19 Mai 2004
son epouse
MADELYN FORTIN
15 Fevrier 1903 - 14 Janvier 1995
ANDRE A.
19 Decembre 1944 - 28 Avril 1945

(R5#62) Cote Monument

West Face:

COTE

East Face:

1881 BELONIE COTE 1945
1899 MARIE ANNE 1967

(R5#63) Letarte Monument

Eternal rest grant
them, O Lord
and let light
perpetual shine
upon them

LETARTE

Marker Stones:

(R5#64) Nov. 26,
1889 ALBERT C.
Mar. 6, LETARTE
1943

(R5#65) Feb. 15,
1885 CLAIRE
Oct. 1, LETARTE
1970

(R5#66) Temple Monument

East Face:

Thy
will be TEMPLE
done

West Face:

FRANK C. TEMPLE
1883 - 1967
his wife
NORA J. BROOKS
1882 - 1944

(R5#67) Roy Monument

ROY

Husband Wife
WILFRED J. REGINA V.
1894 - 1962 1894 - 1947

(R5#68) Field Monument

West Face:

FIELD

East Face:

1882 MARY A. FIELD 1943
 her son
1914 MYRON B. FIELD 2001
 his wife
1918 CECILE A. OUELLETTE

(R5#70) Fortin Monument

West Face:

Jesus
have FORTIN
mercy

East Face:

EDGAR FORTIN
May 19, 1905 - Apr. 6, 1979
his wife
MARY ANNE
May 5, 1907 -
their daughter
DORIS E.
Oct. 5, 1929 - July 11, 1945
their son
Sgt. WILLIAM E.
Nov. 4, 1930 - Sept. 16, 1950

Marker: U.S. Veteran

Marker Stone:

(R5#69) MARY A. FIELD
1882 - 1943

Marker Stones:

(R5#71) DORIS E. FORTIN
Oct. 4, 1929
July 11, 1945

(R5#72) WILLIAM EDGAR FORTIN
Maine
Sgt 1 Marine Div
Nov 4 1930 Sept 16 1950

(R5#73) EDGAR
Father
1905 - 1979

(R5#74) MARY ANNE
Mother
1907 - 1985

RANGE #6
Map #1

WEST

ACCESS ROAD

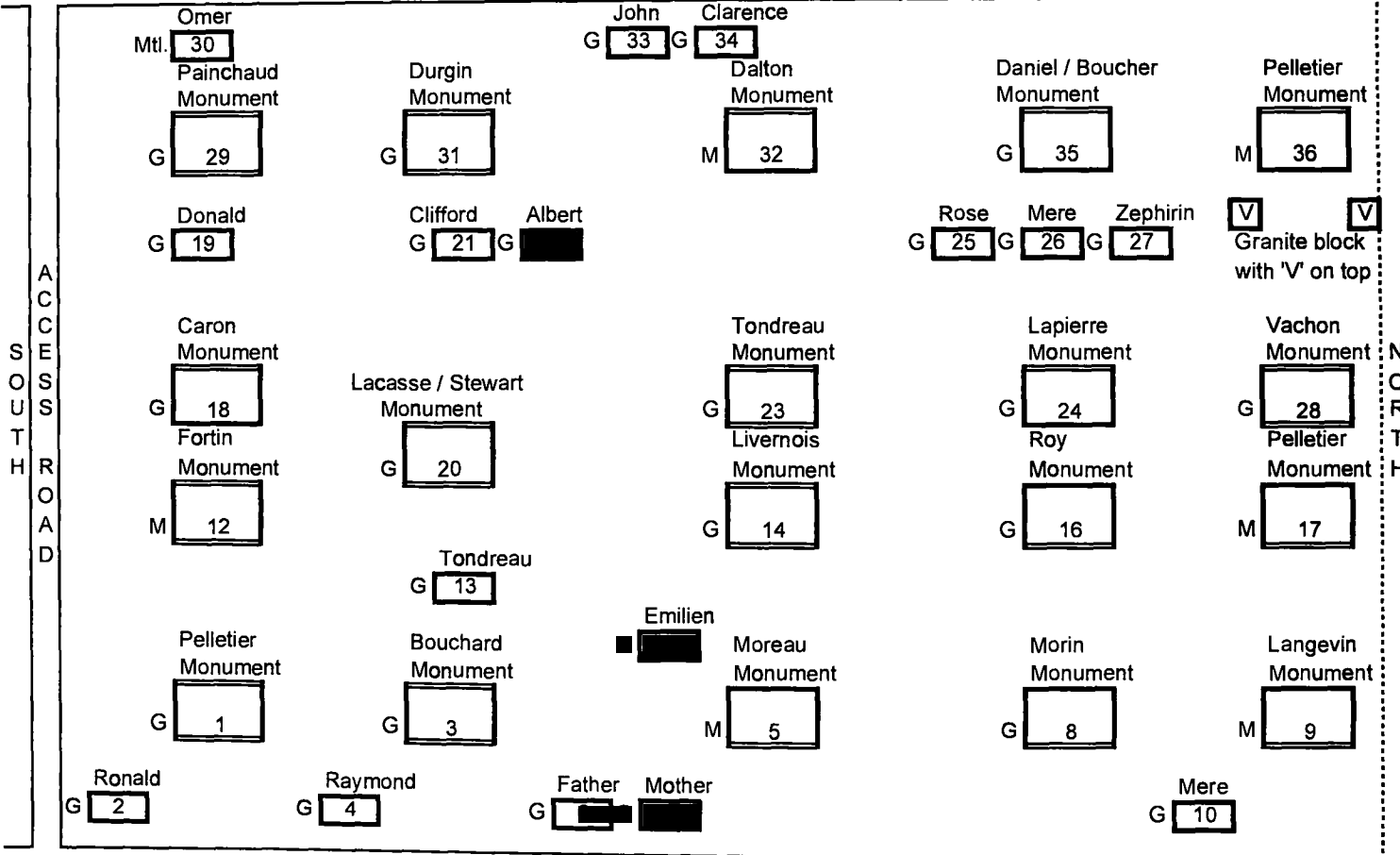

ACCESS ROAD

EAST

ACCESS ROAD

NORTH

RANGE #6
Map #2

WEST

ACCESS ROAD

Levesque G 55 Levesque G 56

Raymond G 59
Tougas Monument G 58

Richards Monument G 57

St. Pierre Monument G 54

Belanger Monument M 53

Poitras Monument G 52

NORTH

Gregoire Monument G 51

Doucette M 47

Levesque Monument M 50
Caron Monument G 46

Roy Monument G 49
Potvin Monument G 45

Caouette Monument G 48
Lachance Monument G 44

Michael G 67 Leo G 68
Biette Monument G 43

Cimon G 42
Lord Monument G 41

Ouellette Monument M 40

St. Pierre Monument M 38

Bernier Monument G 37

Morin M 39

Alice G 11

ACCESS ROAD

EAST

SOUTH

WEST
ACCESS ROAD

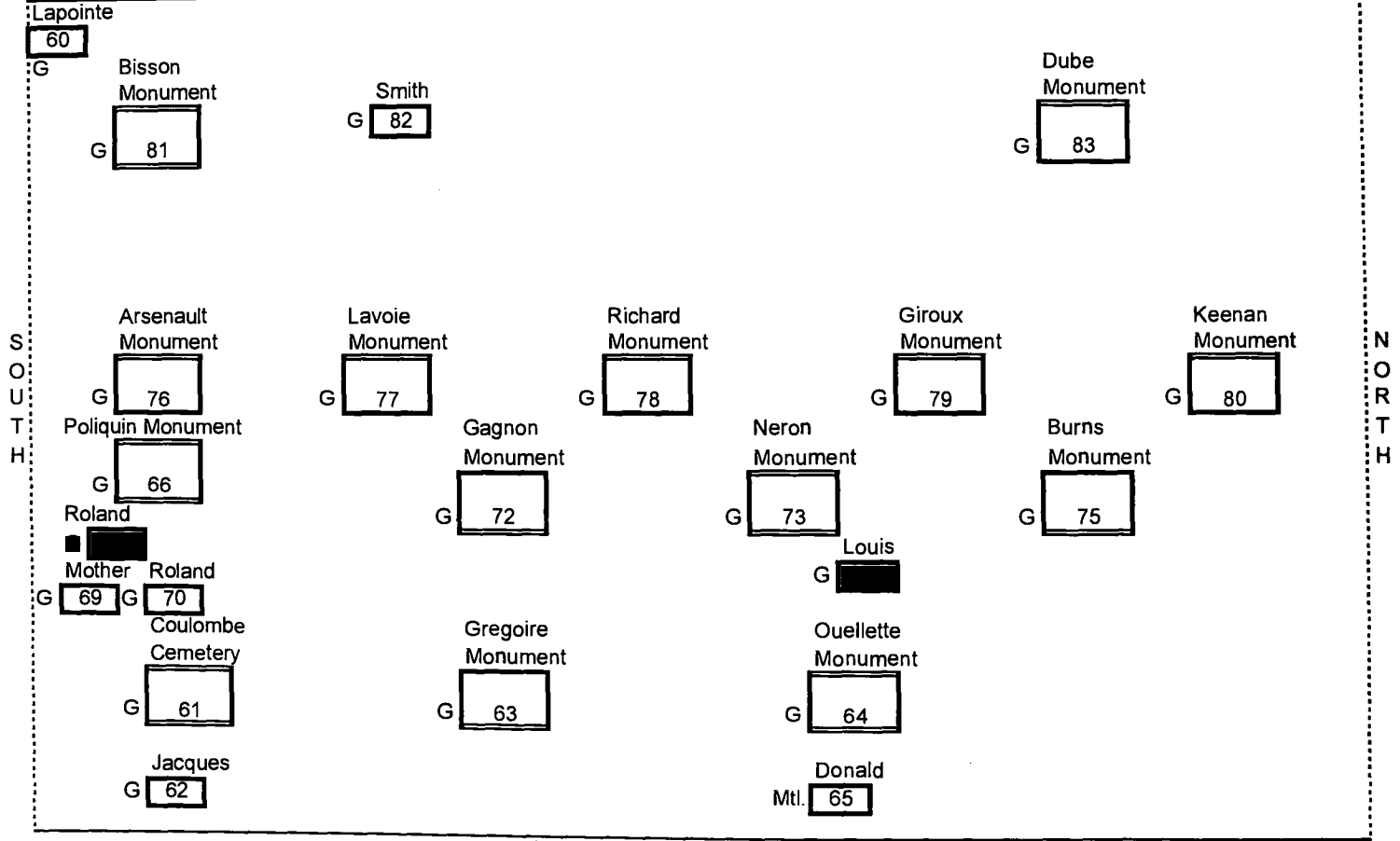

EAST
ACCESS ROAD

RANGE #6
Map #4

W E S T
A C C E S S R O A D

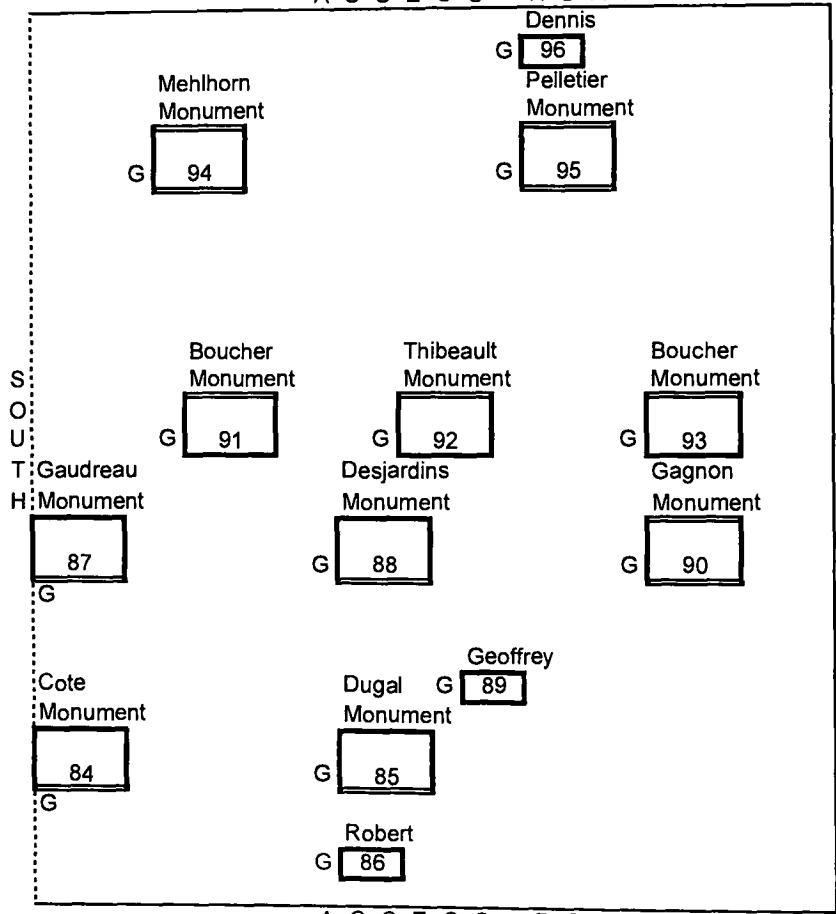

S
O
U
T
H

N
O
R
T
H

A C C E S S R O A D
E A S T

RANGE #6

(R6#1) Pelletier Monument

East Face:

PELLETIER

1916 IRENEE B. 1983
1914 CLAIRE L. his wife 2000

West Face

RONALD M. son 1943
RONALD I. grandson 1962

Marker Stone:

(R6#2) RONALD

(R6#3) Bouchard Monument

East Face:

BOUCHARD

West Face:

J. DORESE
1905 - 1980
MELINA M.
1908 -
RAYMOND A.

3 Juillet 1932 - 8 Novembre 1943

Marker Stone

(R6#4) RAYMOND

(R6#5) Moreau Monument

IHS

MOREAU

LUDGER I.
Feb. 22, 1905
Nov. 8, 1943
his wife
NELLIE B.
Sept. 1, 1907
Apr. 10, 1995

Marker Stones

(R6#6)

Father
LUDGER
1905 - 1943

(R6#7)

Mother
NELLIE
1907 - 1995

(R6#8) Morin Monument

MORIN

1916 HENRY J.
1923 CECILIA D. wife 2000
their children
1943 AGNES 1944
1948 JEANNE & JEANETTE 1948
1957 CAROL ANN 1957
In God's care

(R6#9) Langevin Monument

LANGEVIN

Marker Stones
(R6#10)

Merc
VICTORIA C.
1858 - 1946

(R6#11)

MICHEL
1890 - 1971

(R6#12) Fortin Monument

East Face:

FORTIN

West Face

LUDGER J. FORTIN
1895 - 1951
LAURA M. his wife
1894 - 1967

(R6#13)

FONDREAU

1871 GEORGE J. 1949
1875 HELEN 1948
1899 GEORGE J. Jr 1950

(R6#14) Livernois Monument

East Face:

LIVERNOIS

Marker: U.S. Veteran

Marker Stone:

(R6#15)

EMILIEN G LIVERNOIS

Maine

PFC 26 Inf 1 Inf Div

World War II

Jan 4 1924 March 17 1945

West Face:

1881 PHILIP ZENON 1966

son epouse

1882 ALICE ST. ONGE 1968

leur fils

1924 EMILIEN G. 1945

leur fille

1918 SIMONE M. 2007

(R6#16) Roy Monument

ROY

WILLIAM L. LUCIA TREMBLAY

1881 - 1945

1892 - 1949

(R6#17) Pelletier Monument

DONAT

PELLETIER

1881 - 1944

his wife

DORIMENE LANG

1886 - 1965

(R6#18) Caron Monument

IHS

CARON

1908 WILFRED J. CARON 1947

his wife

1913 MARGUERITE RODRIGUE 1994

Marker Stone:

(R6#19)

DONALD D CARON

Sgt US Marine Corps

Korea

Mar 28 1935 Mar 8 2007

(R6#20) Lacasse / Stewart Monument

West Face:

STEWART

LACASSE

East Face:

ALBERT H. LACASSE

Feb. 23, 1926 - Sept. 10, 1947

CLIFFORD R. STEWART

Nov. 24, 1918 - Nov. 8, 1996

FLORENCE LACASSE STEWART

Aug. 1, 1924

DONALD A. LACASSE

Sept. 6, 1947

Marker Stones:

(R6#21)

CLIFFORD R STEWART

PFC US Army

World War II

Nov 24 1918 Nov 8 1996

(R6#22)

ALBERT HENRY LACASSE

Maine

S1 USNR

World War II

Feb 23 1926 Sept 10 1947

Marker: U.S. Veteran

(R6#23) Tondreau Monument

West Face:

TONDREAU

East Face:

OMER D. TONDREAU

23 Fev. 1879 - 27 Nov. 1947

son epouse

ALICE R. MICHAUD

24 Mai 1879 - 1 Fev. 1966

1902 LILLIAN RACINE 1974

(R6#28) Vachon Monument

West Face:

VACHON

East Face:

Mme NAPOLEON VACHON

1871 - 1954

son fils

J. VALERE VACHON

1906 - 1945

(R6#31) Durgin Monument

East Face:

DURGIN

West Face:

WILLIAM E. DURGIN

1879 - 1955

ALMA R. his wife

1887 - 1950

ALPHONSINE HUDON

1861 - 1945

(R6#24) Lapierre Monument

LAPIERRE

Marker Stones:

(R6#25)

ROSE D. LABBE

1910 - 2005

(R6#26)

Mere

MARIA L. LAPIERRE

8 Mai 1881

3 Nov. 1957

Dites un "Je vous salue Marie"

(R6#27)

ZEPHIRIN LAPIERRE

1873 - 1947

(R6#29) Painchaud Monument

West Face:

PAINCHAUD

East Face:

ALFRED PAINCHAUD

27, Sept. 1873 - 23, Dec. 1954

son epouse

ZENAIDE LACHARITE

25, Dec. 1872 - 7, Oct. 1954

OMER PAINCHAUD

7, Nov. 1902 - 20, Avr. 1975

Marker: U.S. Veteran

Marker Stone:

(R6#30)

OMER H PAINCHAUD

F3 US Navy

1902 - 1975

(R6#32) Dalton Monument

DALTON

Oct. 10, 1880 COLEMAN J. Apr. 11, 1946

Feb. 5, 1884 ROSAMOND A. Nov. 8, 1964

Aug. 11, 1911 CLARENCE W. Sept. 14, 1965

Sept. 6, 1920 JOHN C. Dec. 4, 1987

Marker: U.S. Veteran

Marker Stones:

(R6#33)

JOHN C DALTON

SF2 US Navy

World War II

Sep 6 1920 Dec 4 1987

(R6#34) CLARENCE W DALTON

Maine

SP5 Med Hold Co 30 Inf

World War II Korea

Aug 11 1911 Sept 14 1965

(R6#35) Daniel / Boucher Monument

DANIEL	BOUCHER
THEODORE M.	EMELIA M.
1895 - 1979	1889 - 1985
son epouse	THOMAS L.
DIANE F.	ST. PIERRE
1891 - 1969	1896 - 1983

(R6#36) Pelletier Monument

JEAN BAPTISTE
1890 - 1945
son epouse
ADELIA LECLERC
1896 - 1986
PELLETIER

(R6#37) Bernier Monument

OCTAVE BERNIER
1870 - 1942
epoux de
HENRIETTE TREMBLAY
1870 - 1950
BERNIER

(R6#38) St. Pierre Monument

OSCAR ST. PIERRE
1893 - 1942
son epouse
ROSANNA
PICARD
1895 - 1955

(R6#39) PHILIAS J. MORIN
1892 - 1943

(R6#40) Ouellette Monument

OUELLETTE
LAURA
1890 - 1943
JOSEPH Z.
1892 - 1970

(R6#41) Lord Monument

LORD
JOSEPH D. In loving JEANNETTE
1910 - 1970 memory 1913 - 1981

Marker Stone:

(R6#42) CIMON
1903 - 1946

(R6#44) Lachance Monument

WILLIAM LACHANCE
1892 - 1944
EUGENIE DUVAL
LACHANCE
1900 - 1989

(R6#43) Biette Monument

East Face:

BIETTE

West Face:

1898 FLORIAN J. BIETTE 1970
his wife
1901 ALICE M. LITTLE 1997
1921 CAROLINE LOUISE 1921

(R6#45) Potvin Monument

JOSEPH J. POTVIN
1865 - 1951
son epouse
LEA ROUSSEAU
1878 - 1945

(R6#46) Caron Monument

East Face:

J. E. CARON

West Face:

J. EUGENE CARON

1877 - 1945

MARIE ALICE BELANGER

1880 - 1965

(R6#49) Roy Monument

West Face:

ROY

East Face:

WILBROD P. ROY

1900 - 1994

IRENE ROY

epouse de

WILBROD ROY

1902 - 1946

deuxieme epouse

CHARLOTTE M. ROY

1914 - 2004

(R6#51) Gregoire Monument

GREGOIRE

1895 HENRY J. GREGOIRE 1969

his wife

1895 CLARA ANCTIL 1972

(R6#53) Belanger Monument

BELANGER

(R6#54) St. Pierre Monument

West Face:

ST. PIERRE

East Face:

1878 LUDGER C. 1948

son epouse

1877 ELOISE B. 1963

(R6#47)

MELANIE DOUCETTE

Sept. 14, 1879

Dec. 29, 1944

(R6#48) Caouette Monument

West Face:

CAOUCETTE

East Face:

J. NAPOLEON CAOUCETTE

1878 - 1945

son epouse

VICTORIA LABEL

1865 - 19

(R6#50) Levesque Monument

LEVESQUE

1875

PIERRE

1946

son epouse

1881 LEDA DUFRESNE 1958

Marker: U.S. Veteran

(R6#52) Poitras Monument

POITRAS

EDWARD A.

Mar. 3, 1895 - Dec. 26, 1945

ALMA R. his wife

Sept. 29, 1896 - June 15, 1975

(R6#55)

RITA LEVESQUE

Mar. 9, 1923

Aug. 26, 1968

(R6#56)

JOFFRE G LEVESQUE

Maine

Sgt US Army

World War II

May 16 1917 Sept 5 1970

(R6#57) Richards Monument
RICHARDS
1872 VIRGINIA 1968
her daughter
1900 IDA MARSHALL 1986
In God's care

Marker: U.S. Veteran

(R6#58) Tougas Monument
West Face:
TOUGAS

East Face:
RAYMOND A. TOUGAS M.D.
1905 - 1968
his wife
M. THERESE LAPOINTE
1906 - 1996

(R6#61) Coulombe Monument
East Face:
COULOMBE

West Face:
JACQUES J. COULOMBE
Apr. 27, 1924 - Feb. 12, 1985
his wife
THERESA P. MARIN
Jan. 18, 1926 - Nov. 19, 2003
their daughter
DAWN COULOMBE
Mar. 14, 1970 -

Marker Stones:
(R6#59) RAYMOND A TOUGAS
Maine
Major Medical Corps
World War II
Nov 5 1905 Oct 26 1968

(R6#60) M. THERESE LAPOINTE
wife
mother
grandmother
Aug 14 1906 Apr 22 1996

Marker Stones:
(R6#62) JACQUES J COULOMBE
SK3 US Navy
World War II
Apr 27 1924 Feb 12 1985

(R6#63) Gregoire Monument
GREGOIRE
WILLIAM ROSE BEAUDOIN
1902 - 1981 1902 - 1996

(R6#64) Ouellette Monument
East Face:
OUELLETTE

West Face:
1885 LUDGER 1976
1896 FLORA BUCHARD 1982
1923 DONALD A. 1988
1937 BEVERLY A. KNIGHT
1970 NANCY A. 1970

Marker Stone:
(R6#65) DONALD A OUELLETTE
S1 US Army
World War II
Apr 10 1923 Dec 29 1988

(R6#66) Poliquin Monument
East Face:
POLIQUIN
ROLAND A. SOPHIE M.
1914 - 1978 1919 - 1989

West Face:
1949 MICHAEL E. 1969
1948 LEO J. 1958

Marker Stones:

(R6#67)

MICHAEL E POLIQUIN
Maine
PFC US Marine Corps
Vietnam Nam - PH
April 25 1949 Aug 19 1969

(R6#68)

Now I lay me down to sleep
LEO J.
beloved son of
ROLAND & SOPHIE POLIQUIN
Feb. 24, 1948 Nov. 25, 1958
I pray the Lord my soul to keep

(R6#69)

Mother
SOPHIE

(R6#71)

ROLAND J.
Jan. 10, 1962
Oct. 13, 1998

(R6#70)

ROLAND A POLIQUIN
S1 US Navy
World War II
Mar 14 1914 Jan 4 1978

(R6#72) Gagnon Monument

GAGNON

IRENE C. WILLIAM
1909 - 1987 1898 - 1969

(R6#73) Neron Monument

East Face:

NERON
ORIAS ADELE
NERON BERGERON
1896 - 1985 1897 - 1973

West Face:

their son
1928 LOUIS J. NERON 2006
his wife
1936 LUCY A. CLOUTIER

(R6#75) Burns Monument

BURNS

1931 NORMAN J. Sr. 1969
his wife
1934 RACHEL R.
Together forever

Marker Stone:

(R6#74) LOUIS J NERON
BM1 US Navy
Feb 13 1928 Aug 9 2006
beloved
husband father grandfather

(R6#76) Arsenault Monument

ARSENAULT

J. WILLIAM WILLIAM A.
1880 - 1968 1878 - 1969

(R6#78) Richard Monument

RICHARD

EDMUND J. ELEANOR J.
1905 - 1981 1908 - 1969

(R6#77) Lavoie Monument

LAVOIE

ARMAND J. ALEXINA A.
1903 - 1969 1906 - 1968

(R6#79) Giroux Monument

GIROUX
WILFRID A. Sr.
Dec. 20, 1904
Jan. 27, 1979
ALICE F. his wife
Feb. 26, 1907
Jan. 15, 1976

(R6#80) Keenan Monument

KEENAN
CLARA M. RALPH H.
1910 - 1974 1909 - 1969

(R6#82)

SMITH
TIMOTHY G.
Feb. 9, 1961 - May 23, 2000

(R6#81) Bisson Monument

West Face:
BISSON
Thy will
be done
Together forever

East Face:
1906 JOSEPH F. BISSON 1989
his wife
1911 DELIA DEROCHER 1989

(R6#83) Dube Monument

DUBE
1897 JOSEPH A. DUBE 1968
his wife
1897 ROSE M. PARADIS 1981
Jesus Mary Joseph

(R6#84) Cote Monument

COTE
HELENA DOMINIQUE
1910 - 1970 1907 - 2000

(R6#85) Dugal Monument

DUGAL
ROBERT BERNADETTE JEANNETTE
Oct. 5, 1918 Mar. 2, 1922 July 8, 1911
Oct. 4, 2002 Oct. 6, 1988
In loving memory

Marker Stone:
(R6#86) ROBERT U DUGAL
Sgt US Army
World War II
Oct 5 1918 Oct 4 2002

Marker: U.S. Veteran

(R6#88) Desjardins Monument

DESJARDINS
1919 GEOFFREY L. Jr. 2003
1921 MARY D. his wife 1985
1955 THOMAS E. their son 1969

Marker: U.S. Veteran

(R6#87) Gaudreau Monument

GAUDREAU
Husband Wife
HENRY J. YVONNE
1906 - 1986 1916 - 1980

Marker Stone:

(R6#89) GEOFFREY L DESJARDINS Jr
S Sgt US Army
World War II
1919 2003

(R6#90) Gagnon Monument

East Face:

GAGNON

West Face:

1909 LOUIS P. GAGNON 1970

his wife

MARY G. MARCIN

(R6#91) Boucher Monument

BOUCHER

JEAN A. In God's care IDA M.
1906 - 1969 1907 - 1989

(R6#92) Thibeault Monument

THIBEAULT

ALFRED M. DELIA
1897 - 1992 1902 - 1969

(R6#93) Boucher Monument

BOUCHER

1910 HENRY A. BOUCHER 1987

his wife

1908 NOELLA O. MARTIN 2001

1902 JOSEPH M. BOUCHER 1969

1912 MARIE A. BOUCHER 1981

(R6#94) Mehlhorn Monument

West Face:

MEHLHORN

HERBERT E. HELENA H.

East Face:

HERBERT E. MEHLHORN

Jan. 4, 1899 Sept. 3, 1991

HELENA H. his wife

July 28, 1894 June 6, 1980

(R6#95) Pelletier Monument

West Face:

PELLETIER

Into thy hands I commend my spirit

East Face:

DENNIS C. PELLETIER

1944 - 1970

Marker: U.S. Veteran

Marker Stone:

(R6#96)

DENNIS C PELLETIER

Maine

1st Lt Btry H 18 Arty

Vietnam Arcom - BSM

April 13 1944 March 21 1970

RANGE #7
Map #1

W E S T

A
C
C
E
S
S
R
O
A
D
N
O
R
T
H

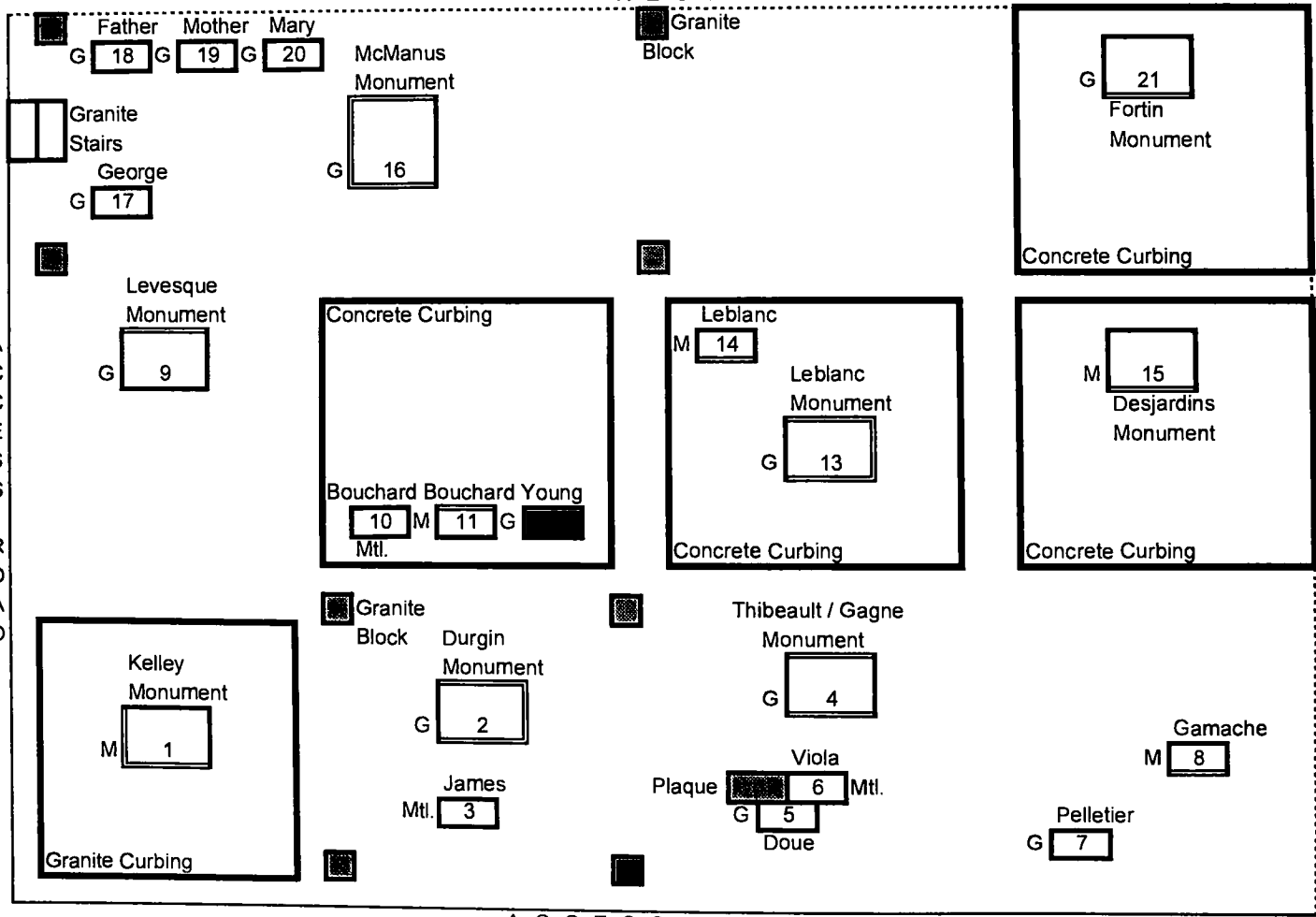

Father Mother Mary
G 18 G 19 G 20

McManus
Monument

Granite
Block

G 21
Fortin
Monument

Granite
Stairs
George
G 17

G 16

Concrete Curbing

Levesque
Monument

Concrete Curbing

Leblanc

Concrete Curbing

G 9

M 14

Leblanc
Monument

M 15
Desjardins
Monument

Bouchard Bouchard Young
Mtl. 10 M 11 G

G 13

Concrete Curbing

Granite
Block Durgin
Monument
G 2

Thibeault / Gagne
Monument

G 4

Kelley
Monument
M 1
Granite Curbing

James
Mtl. 3

Viola
Plaque G 5 Mtl. 6

Doue
G 5

Gamache
M 8

Pelletier
G 7

A C C E S S R O A D
E A S T

WEST
ACCESS ROAD

A
C
C
E
S
S
R
O
A
D

S
O
U
T
H

Levesque Fournier
M 42 M 43
(Dwn.)
G 48 G 49 G 50 G 51

Lavoie
G 53

John Mere John Pere
58 59 60
M M M M
M 55 M 56
Delia Valeda
Mutt / Sawyer Monument
M 54
Granite Curbing

Conrad Lucille Ronald
G 45 G 46 G 47
McDuff
Monument
G 44

Bois
Monument
G 52

Fournier Normand Fournier
M 39 M 40 M 41

Concrete Curbing
Tremblay
Monument
M 27
Cyrille
Mtl. 28

Deroche Deroche Deroche
G 30 G 31 G 32

Gamache
Monument
G 33

Laura Francois
G 35 M 34 G 36
Leblanc
Monument
Michel Pere
Mtl. 37 G 38
Concrete Curbing

Coulombe
G 29

Cates
M

M 25
Caouette
Monument
Concrete Curbing

M 26
Desjardins
Monument
Concrete Curbing

Donnelly Haskell
M 23 M 24

E A S T

RANGE #7
Map #3

W E S T

N
O
R
T
H

S
O
U
T
H

Pouliot - Bouchard Monument

G 85

Christman Normand

M 94 M 95

Mere Pere

M 97 M 98

Bernier
Monument

M 96

St. Pierre
Monument

M 84

James

G 90

William Albia Doris Jeannette Fournier Fournier Fournier
G 86 G 87 G 88 G 89 Mtl. 91 G 92 93 Mtl.

Belanger

Gamache Gamache Monument
G 80 G 81 G 78

Thibeault
Monument

G 82

Labbe

M 83

Granite Curbing

Lapointe
Monument

M 74

Alexina Louise Emma

G 75 G 76 G [REDACTED]

Jean / Eva

G 79

Mary Richard Daughter

G 63 G 64 G 65

Gamache

M 66

Letarte Letarte Letarte

M 67 M 68 M 69

Jordan

G 62

Leonard
Monument

G 61

Granite
Curbing

G 70

Paquette
Monument

Angeline Mere Pere

G 71 G 72 G [REDACTED]

A C C E S S R O A D

E A S T

WEST
ACCESS ROAD

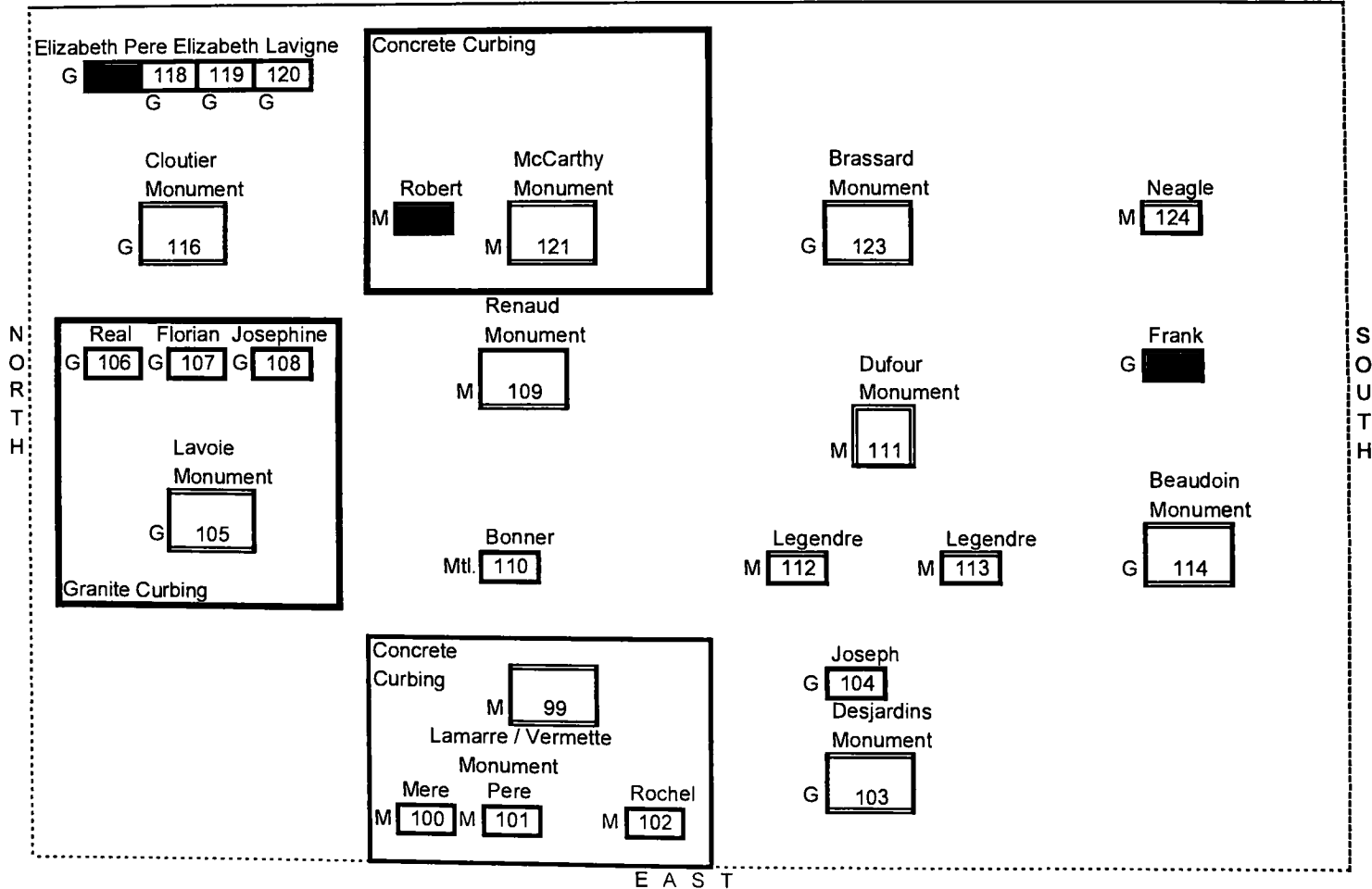

RANGE #7

Map #5

W E S T

N
O
R
T
H

A
C
C
E
S
S
R
O
A
D

A C C E S S R O A D

E A S T

Leclerc
G 140
Coulombe
Monument
G 139

Elizabeth Sadie Mere Pere
G 144 G 145 G 146 G 147
Caron
Monument
G 141
Yvonne Eugene
Ganite G 142 G 143
Curbing

R. Josephine
M 131 M []
Jos. Alfred
M 130
St. Pierre Monument
Concrete Curbing

Laura Catherine Joseph Laureat
135 136 137 138
Mtl. Mtl. Mtl. Mtl.
Coulombe
Monument
G 133
Omer
Mtl. 134

G 125
Desjardins
Monument
Granite Curbing

Gagnon Perrault Dube
M 126 M 127 M 128 M 129
(Brkn.) Perrault

RANGE #7

Map #6

WEST

ACCESS ROAD

ACCESS ROAD
SOUTH

EAST

Father M 161 M Mother M 162 M Bart. M 163 M James M 164

John M 165

Dolan Monument M 160

NORTH
James M 154 M Catherine M 155 M Mary M 156

Madden Monument M 152

Muir M 157 M Muir M 158 M Rooney M 159

Jane M [REDACTED]

G 148 Favreau Monument
Mathilda G 149
Concrete Curbing

Tetu G [REDACTED]

G 150 Tetu / Guertin

RANGE #7

(R7#1) Kelley Monument

East Face:

ELLEN KELLEY
died
July 30, 1906
Ae. 77 yrs.
KELLEY

South Face:

MARY E. KELLEY
died
Aug. 12, 1854
Ae. 11 mos. 8 dys

(R7#2) Durgin Monument

East Face:

WILLIAM DURGIN
1850 - 1893
ROSA, his wife
1853 - 1920
MARY A. their dau.
1881 - 1940
DURGIN

North Face:

CATHERINE
DURGIN
1877 - 1880

West Face:

JAMES E. DOUGHERTY
1888 - 1958
KATHERINE E. his wife
1887 - 1979

Marker Stone:

(R7#3) JAMES E DOUGHERTY
Maine
CFR 1 Cl Air Service
World War I
Nov 3 1888 Dec 12 1958

(R7#4) Thibeault / Gagne Monument

East Face:

THIBEAULT
GAGNE
DOUE A. GAGNE, Jr.
Nov. 16, 1947 - June 17, 1960
In loving memory

West Face:

1882	JOHN THIBEAULT	1964
	his wife	
1878	JOSEPHINE THIBEAULT	1970
1919	DOUE A. GAGNE	2003
	his wife	
1918	VIOLA ARSENAULT	1999
	children	
1946	WILLIAM A.	1946

Marker: U.S. Veteran

Marker Stones:

(R7#5) DOUE A GAGNE (R7#6)
Tec 5 US Army
World War II
Sep 29 1919 Apr 15 2003

In memory of
VIOLA
1918 - 1999
Rest in peace

Plaque:

If tears could build a
stairway, and memories
a lane, I'd walk right up
to heaven and bring
you home again.

(R7#7) EMILIA F. PELLETIER
1898 - 1950

(R7#8) Ici
repose le corps de
CHARLES GAMACHE
decede le 22, Mars, 1891,
age de 68 ans.
Priez pour lui

(R7#9) Levesque Monument
LEVESQUE
ANGELINE BRETON
1911 - 1963
son epoux
JOSEPH LEVESQUE
1908 - 1965
enfant de prague priez pour nous

(R7#10) ELZEAR A. BOUCHARD
1878 - 1947

(R7#12) EMELIA B. YOUNG
Oct. 4, 1894 - Aug. 26, 1957
"Say a Hail Mary"

(R7#11) ABRAHAM BOUCHARD
decede le 19, Sept. 1912
a l'age de 57 ans.
son epouse
MARIE
decede le 25 Aout 1932
a l'age de 77 ans.

(R7#13) Leblanc Monument

East Face:

PIERRE LEBLANC
decede 19 Aout 1906
76 ans, 10 ms, 25 jrs.
epoux de
ADELE DECHENE
LEBLANC

North Face:

AUDELI 1880
FEDELINE 1880
ROSE 1886
JOSEPHINE 1895

West Face:

ADELE DECHENE
epouse de
PIERRE LEBLANC
decedee 1, Oct. 1913
76 ans, 8 mois, 3 jours

Marker Stone:

(R7#14)

GAUDELIE decedee
le 24 Mars 1880,
agee de 9 ans.
PHEDELINE decedee
le 24 Mars 1880
agee de 1 an 2 mois
ROSE ANNA decedee
le 29 Juin 1886
agee de 9 1/2 ans.
enfants de
PIERRE LEBLANC

(R7#16) McManus Monument

East Face:

GEORGE M. McMANUS
died Feb. 21, 1914
aged 44 yrs.

West Face:

MARY A. McMANUS
1856 - 1934

South Face:

A loveing husband
and kind father

PATRICK McMANUS
died Jan. 29, 1891
age 74 yrs. 10 mos.

MARGARET his wife
died Jan. 26, 1903
age 77 yrs.

We miss thy kind and willing hand
thy fond and earnest care,
our home is dark without thee
we miss thee everywhere.
McMANUS

(R7#15) Desjardins Monument

Dr. ANATOLE F. DESJARDINS

Graduate of Boston University
Medical School Class of 1925
Feb. 10, 1893 - Sept. 18, 1941

EVARIUS DESJARDINS
July 10, 1868 - Sept. 25, 1962
his wife

MATHILDA LAPOINTE
Oct. 14, 1867 - Jan. 7, 1945

Marker Stones:

(R7#17) GEORGE

(R7#18) FATHER

(R7#19) MOTHER

(R7#20) MARY A.

(R7#21) Fortin Monument

IHS

1859 OCTAVE FORTIN 1926
ses epouse

1863 GEORGIANNA DESJARDIN 1889

1870 MARIE C. CARON 1927

1884 FLORIAN E. FORTIN 1928
son epouse

1885 EMMA E. MOREAU 1946
FORTIN

(R7#22) Top of stone:

CATES

Face of stone:

ALAMANDO

1871 - 1892

WM. A.

son of

A. & ANNIE CATES

1893 - 1897

(R7#23)

JANE A.
wife of
MICHAEL DONNELLY
died June 24, 1901
Ae. 95 yrs.

(R7#24)

MARY A.
wife of
EDWIN HASKELL
born Apr. 22, 1844
died Feb. 20, 1892
A precious one from us has gone,
a voice we loved is stilled;
A place is vacant in our home,
which never can be filled.

(R7#25) Caouette Monument

East Face:

IHS
DAMASE CAOUCETTE
1850 - 1918
son epouse
CATHERINE
1856 -
CAOUCETTE

West Face:

ARTHUR CAOUCETTE
1875 - 1924
ELZEARD CAOUCETTE
1879 - 1916
DENIS CAOUCETTE
1896 - 1926

(R7#26) Desjardins Monument

East Face:

ALFRED
DESJARDINS
1886 - 1947
son epouse
JULIA
BERNIER
1908 - 1994
DESJARDINS

North Face:

MAXIME
MICHAUD
1873 - 1918

South Face:

ELZEARD
DESJARDINS
1859 - 1890
AMEDEE
BELANGER
1868 - 1924
son epouse
MARIE
VIRGINIA
1855 - 1928
autre fois epouse de
ELZEARD DESJARDINS

West Face:

ALFRED
1883 - 1884
JOHN
1882 - 1886
enfants de
ELZEARD & VIRGINIA
DESJARDINS

(R7#27) Tremblay Monument

JOSEPH TREMBLAY
1857 -
son epouse
EMMA CARON
1866 - 1933
TREMBLAY

Marker Stone:

(R7#28)

CYRILLE
TREMBLAY
1873 - 1941

(R7#29)

ROGER COULOMBE
Feb. 13, 1950 - Feb. 13, 1950
ROXANNE J. COULOMBE
Dec. 11, 1956 - Jan. 27, 1957

(R7#30)

GEORGIANA DEROUCHE
HANEY
1897 - 1985

(R7#32)

LUCIPE DEROUCHE
1860 - 1915

(R7#31)

GEORGIANA DEROUCHE
1871 - 1959

(R7#33) Gamache Monument

West Face:

GAMACHE

East Face:

LIONEL J. GAMACHE

February 21, 1915

January 16, 1983

ANITA A. his wife

June 24, 1920

(R7#34) Leblanc Monument

West Face:

ROSARIO L. LEBLANC

1867 - 1943

son epouse

MARY RACINE

1870 - 1938

LEBLANC

South Face:

LOUIS LEBLANC

1838 - 1919

PRUDENT P.

1895 - 1895

ALPHONSINE J.

1898 - 1900

RODOLPHE U.

1903 - 1918

MICHEL N.

1901 - 1965

North Face:

FRANCOIS D. LEBLANC

1896 - 1978

son epouse

LAURA M. THIBAUT

1888 - 1956

fille

CARMELLA

1927 - 1994

Marker Stones:

(R7#35)

LAURA

(R7#36)

FRANCOIS D LEBLANC

US Army

World War I

Oct 24 1896 Oct 15 1978

(R7#39)

Ici repose le corps de
DERILDO FOURNIER

epouse de

ALFRED NORMAND

decede le 18, Dec 1892

a l'age de 26 ans 6 moi

Priez pour elle

(R7#37)

MICHEL N LEBLANC

1901 - 1965

(R7#38)

PERE

(R7#40)

Ici repose le corps

J. L. ALFRED

NORMAND

decede

le 20 Avril 1898,

a l'age

de 11 mois et 2 jours

(R7#41)

Ici
repose le corps
de
JOSEPH FOURNIER
decede

le 27, Fevrier 1896

a l'age

de 18 aus.

Prier pour lui

(R7#42)

IHS
Ici repose le corps de
AGLAE LEVESQUE
veuve de
DIDIER FOURNIER
decedee le 3 Avril 1914
a l'age de 64 ans 11 mois

(R7#43)

Ici repose le corps de
DIDIER FOURNIER
epoux
d' AGLAE LEVEQUE
decede le 2 Mai 1907
a l'age de 65 ans et 15 jours
Prier pour lui

(R7#44) McDuff Monument

West Face:

McDUFF
Mother of God pray for us.

East Face:

1832	PIERRE McDUFF	1925
	his wife	
1842	SOPHIE MESSIER	1893
1870	JOHN B. McDUFF	1958
	his wife	
1875	ROSE ANNA PAINCHAUD	1940
	son	
1909	NUMA J. McDUFF	1994
	his wife	
1911	JEANNE E. BERNIER	2001
1919	CONRAD M. McDUFF	1998
	his wife	
1922	LUCILLE J. OUELLETTE	1998
	their son	
1942	RONALD J. McDUFF	2001

Marker Stones:

(R7#45)	CONRAD
(R7#46)	LUCILLE
(R7#47)	RONALD
(R7#48)	FATHER 1870 - 1958
(R7#49)	MOTHER 1875 - 1940
(R7#50)	JEANNE
(R7#51)	NUMA

(R7#52) Bois Monument

BOIS
EMERILDA JOSEPH A.
1892 - 1985 1892 - 1982

Marker: U.S. Veteran

(R7#53)

ALBERT LAVOIE
Maine
PFC Co D 318 Infantry
World War I
May 31 1890 Sept 25 1962

(R7#54) Mutty / Sawyer Monument

West Face:

MUTTY

SAWYER

East Face:

1857 JOHN B. MUTTY pere 1893

epoux de ADELE KIROUAC

1888 JOHN B. MUTTY fils 1918

1890 DELIA C. MUTTY 1963

1868 CHARLES P. SAWYER 1949

son epouse

1862 ADELE KIROUAC 1939

1907 LUCIEN SAWYER 1908

1904 VALEDA SAWYER 1992

Marker Stones:

(R7#55)

DELIA C. MUTTY

(R7#56)

VALEDA E.
SAWYER

(R7#57)

JOHN B. MUTTY
Pere

(R7#58)

MERE

(R7#59)

JOHN B. MUTTY
Fils

(R7#60)

C. P. SAWYER
Pere

(R7#61) Leonard Monument

East Face

JOHN B. LEONARD

1859 - 1919

MARY E. his wife

1861 - 1940

MARY A. wife of

DAVID NEAGLE

1819 - 1883

West Face

JAMES F. LEONARD

1885 - 1929

JAMES F. LEONARD

1912 - 1961

Marker Stones

(R7#62)

JORDAN M. LEONARD

Feb. 23, 1996

Feb. 23, 1996

(R7#63)

MARY dau. of
JAMES & SYBIL
LEONARD
age 10 mos

(R7#64)

RICHARD P. LEONARD

Feb. 3, 1938

Sept. 15, 2002

(R7#65)

Daughter
CAROL ANN PHARRIS
1941 - 1987

(R7#66)

ALFRED

enfant de

BLAISE et EMELIE

GAMACHE

le decede le 11 Juillet 1884

a l'age de 7 mois

(R7#67)

Priez pour l'ame
de
JOSEPH F. FARTE
decede
le 18 Juillet 1875
age de 42 ans

(R7#68)

Priez pour l'ame
de
JOSEPH LETARTE fils
decede
le 4 Juillet 1884
age de 29 ans et 6 mois

(R7#69)

CHARLES LETARTE
1862 - 1893
son epouse
ANGELINE PLOURDE
1865 - 1917
priez pour eux
LETARTE

(R7#70) Paquette Monument

IHS
1856 JOSEPH A. PAQUETTE 1931
son epouse
1855 LAURE ST. ONGE 1930
1886 JOACHIM V. PAQUETTE 1942
son epouse
1891 MARIE-LOUISE CARLOS 1969
PAQUETTE

Marker Stones:

(R7#71) ANGELINE
1880 - 1953

(R7#72) MERE

(R7#73) PERE

(R7#74) Lapointe Monument

TELESPHORE LAPOINTE
1858 - 1930
son epouse
LOUISE DESMARAIS
1863 - 1944
LAPOINTE

Marker: U.S. Veteran

Marker Stones:

(R7#75) ALEXINA
1889 - 1978

(R7#76) LOUISE
1902 - 2001

(R7#77) EMMA
1902 - 1982

(R7#78) Belanger Monument

BELANGER
JEAN B. BELANGER Jr.
1902 - 1964
son epouse
IDA HUARD
1905 - 1993
Jesus Marie Joseph

Marker Stones:

(R7#79) JEAN B. BELANGER Sr.
1880 - 1942
EVA D. GAUDREAU
1890 - 1987

(R7#80) EDWARD J. GAMACHE
1930 -
his wife
MURIEL M. GAMACHE
1934 -

Marker Stones Cont'd.:

(R7#81)

DANIEL E. GAMACHE

1956 - 1956

MICHAEL E. GAMACHE

1957 - 1957

Infant sons of EDWARD and MURIEL

(R7#82) Thibeault Monument

East Face:

THIBEAULT

West Face:

LEONCE A. THIBEAULT 1875 - 1950

EVA ROY THIBEAULT HACHEY

born Nov. 24, 1903 - died Oct. 29, 1959

(R7#83)

AMANDA LABBE,

decedee

le 7 Juin 1884

a l'age de 17 ans

10 mois 21 jours

pries pour elle

(R7#84) St. Pierre Monument

East Face:

Ici repose le corps de

NOEL ST. PIERRE

decede le 9 Aug. 1909,

a l'age de 65 ans.

West Face:

NOEL ST. PIERRE

decede le 9 Aug. 1909

a l'age de 65 ans.

(R7#85) Pouliot - Bouchard Monument

East Face:

POULIOT - BOUCHARD

Marker: U.S. Veteran

West Face:

1896 WILLIAM J. POULIOT 1951

1896 ALBIA C. his wife 1991

1929 JAMES R. BOUCHARD 1959

1929 LORRAINE M. his wife

Marker Stones:

(R7#86)

WILLIAM J POULIOT

Maine

Pvt 36 Infantry 12 Div

World War I

July 30 1895 July 9 1951

(R7#87)

ALBIA C POULIOT

wife of

WILLIAM POULIOT

Nov 27 1896 Apr 3 1991

Marker Stones Cont'd.:

(R7#88)

DORIS POULIOT
TOOTHAKER
1923 - 1966

(R7#89)

JEANNETTE LABERGE
1943 POULIOT 1963
epouse de
JOSEPH R. POULIOT

(R7#90)

JAMES R BOUCHARD
Maine
Pvt 44 Bn Repl JNG Center
Feb 5 1929 April 6 1959

(R7#91)

ALEXIS J FOURNIER
1903 - 1965

(R7#92)

MARIE ROSE FOURNIER
1898 - 1981

(R7#93)

EMMA FOURNIER
1863 - 1950

(R7#94)

Pries pour l'ame
de
DELIMA CHRISTMAN
epouse de
F. X. NORMAND
decede de 28 Mai 1884
a l'age de 29 ans 9 mois

(R7#95)

M. O. A. NORMAND
decede
le 9 Nov. 1886.
agee de 5 ans et 2 mois

(R7#96) Bernier Monument

East Face:

BERNIER

Marker Stones:

(R7#97)

GRAND MERE

West Face:

CAMILLE R. BERNIER
1880 - 1944
son epouse
MARIE LOUISE LABBE
1886 - 1937

(R7#98)

GRAND PERE

(R7#99) Lamarre / Vermette Monument

East Face:

LUDGER
1886 - 1956
son epouse
FEDORA
VERMETTE
1888 - 1935
ROCHEL L.
1924 - 1943
LAMARRE

West Face:

JOSEPH
VERMETTE
1852 - 1935
son epouse
VICTORIA
1861 - 1924
enfant children
M. MELINA 1877
MARIE 1879
VERMETTE

Marker Stones:

(R7#100) MERE

(R7#101) PERE

(R7#102) ROCHEL L LAMARRE
Maine
PFC 157 Inf 15 Inf Div
World War II
Jan 9 1924 Dec 10 1943

(R7#103) Desjardins Monument

East Face:

DESJARDINS

Marker: U.S. Veteran

West Face:

1897 JOSEPH H. DESJARDINS 1977
1902 HELEN E. his wife 1935
1909 MARGUERITE M. his wife 2002

Marker Stone:

(R7#104) JOSEPH H DESJARDINS
Pvt US Army
World War I
1897 1977

(R7#105) Lavoie Monument

West Face:

LAVOIE
Not my will but thine be done

East Face:

Hear your loved ones softly pleading
from the green graves lonesome lying
ever crying:

"Have pity ! You at least, my friends"

FLORIAN J. LAVOIE
Mar. 6, 1897 - May 3, 1960
his wife
JOSEPHINE CARON
July 15, 1901 - Oct. 8, 1986

Marker Stones:

(R7#106) REAL LEBLANC
1862 - 1930
epoux de
ODELIE LABEL
1862 - 1940

(R7#107) FLORIAN
en repos

(R7#108) JOSEPHINE

(R7#109) Renaud Monument

Priez
peu les aives
de
epouse de
EUCCHARISTE RENAUD
decedee
le 3 Avril 1893
a l'age de 51 ans.
VICTORIA RENAUD
decedee
le 13 Mars 1886
a l'age de 15 ans.
DELIA RENAUD
decedee
le 26 Mars 1886
a l'age de 17 ans.
Requiescant in pace.

Marker Stone:
(R7#110)

ANNIE BONNER
May 28, 1866 April 21, 1938

(R7#111) Dufour Monument

East Face:

ALFRED DUFOUR
decede
27 Juillet 1890
age 43 ans.
son epouse
nee
ELISE TRUCHON
decede
16 Mai 1919
age 66 ans.
R. I. P.
DUFOUR

North Face:

Mme. DAVID
DUCHAIINE
nee
LAURA DUFOUR
decedee
7 Oct. 1959
a l'age de 74 ans

South Face:

LOUISE DUFOUR
decede
7 Octobre 1890,
age 11 ans.
HELENE DUFOUR
decede
31 Aout 1889,
age 2 mois

Marker Stones:

(R7#112)

HENRIE A. LEGENDRE
decedee le 4 Juillet
1918
agee de 16 ans.
R. I. P.

(R7#113)

HELENE LEGENDRE
decedee le 26 Juillet
1903
agee de 8 mois

(R7#114) Beaudoin Monument

West Face:

BEAUDOIN
FRANK J. MARY L.
BEAUDOIN FORTIN
1900 - 1987 1908 - 1990

East Face:

1864 FRANCOIS BEAUDOIN 1944
1935 J. R. MARIE BEAUDOIN 1938

Marker Stone:

(R7#115) FRANK J BEAUDOIN
Pvt US Army
World War I
Apr 21 1900 Jul 11 1987

(R7#116) Cloutier Monument

West Face:

CLOUTIER

East Face:

GUSTAVE CLOUTIER
25 Nov. 1880 - 2 Aout 1954
son epouse
ELIZABETH LAVIGNE
10 Fev. 1880 - 31 Janv. 1963

Marker Stones:

(R7#117) ELIZABETH
1880 - 1963

(R7#118) Pere
GUSTAVE
1880 - 1954

(R7#119) Soeur et tante
ELIZABETH M. R.
1906 - 1978

(R7#121) McCarthy Monument

West Face:

JOHN J. McCARTHY
1865 - 1937
his wife
CHRISTINE ANN
1859 - 1894
MARY JANE
1864 - 1933
McCARTHY

East Face:

MAMIE ANNIE
1885 - 1888
FRANK EDWARD
1896 - 1898
JOHN ANGUS
1889 - 1918
MARY AGNES
1894 - 1929

(R7#120)

LAVIGNE
ISRAEL CAROLINE
1849 - 1893 1844 - 1922

Marker Stone:

(R7#122)
ROBERT C McCARTHY
Maine
PFC 45 AF Air Supply
World War II
Aug 11 1927 July 8 1949

(R7#123) Brassard Monument

West Face:

BRASSARD

East Face:

ADELARD BRASSARD

1878 - 1943

son epouse

CLARA VAILLANCOURT

1868 - 1939

ALBERT P. BRASSARD

1902 - 1954

DONELDA BRASSARD

1906 - 1984

(R7#124)

MICHAEL NEAGLE

died

Nov. 12, 1866

Act. 48 yrs.

MARGARET

dau. of

MICHAEL & BRIDGET

NEAGLE.

died Mar. 3, 1859

Act. 1 year

(R7#125) Desjardins Monument

East Face:

1856 BENJAMIN DESJARDINS 1925

son epouse

1855 ROSALIE MATHURIN 1939

1874 HORMISDAS DESJARDINS 1936

son epouse

1874 MARGARET GILMORE 1939

DESJARDINS

West Face:

Enfants

1876 MELINA 1878

1878 MARIE MELINA 1879

1884 ARMAND 1886

1885 ELBRIDGE 1886

-

1826 PIERRE DESJARDINS 1891

(R7#126)

Ci Git

DELVINA GAGNON

epouse de

CHARLES PERREAULT

decedee le

8 Fevrier 1891

.....
(Stone broken)

(R7#127)

ABEL

enfant de

CHARLES et DELVINA

PERREAULT

decedee le

12 Avril 1891

et l'age de

3 mois 12 jours

(R7#128)

Ici repose de

corps de

MARIANNE

PERRAULT

decedee le

10 Aout 1898

a l'age de 18 jours

(R7#129)

Ici

repose le corps

de

RAPHAEL DUBE

epoux de

CELINA MATHURIN

decede

le 26 December 1890

a l'age de

34 ans et 5 mois

priez pour lui.

(R7#130) St. Pierre Monument
ST. PIERRE
LOUIS D. ST. PIERRE
1853 - 1935
JOSEPHINE son epouse
1857 - 1952
EDDIE
1879 - 1929

(R7#131) R. JOSEPHINE
fille de
LOUIS & JOSEPHINE
ST. PIERRE
decedee
Mai 28, 1883
agee de 1 ans 3 mois

(R7#133) Coulombe Monument
Famille de
JOSEPH N.
COULOMBE
1897 EMILIA M. 1984
Jesus Marie Joseph

(R7#132) JOS. ALFRED
fils de
LOUIS & JOSEPHINE
ST. PIERRE
decede
Sept. 3, 1880
de 5 mois 3 sem.

Marker Stones:

(R7#134) OMER COULOMBE
1896 - 1912

(R7#135) LAURA S. COULOMBE
1890 - 1948

(R7#136) CATHERINE COULOMBE
1856 - 1944

(R7#137) JOSEPH N.
COULOMBE
1855 - 1938

(R7#138) LAUREAT
COULOMBE
1884 - 1936

(R7#139) Coulombe Monument

East Face:

COULOMBE
1900 ALFRED J. Sr. 1978
his wife
1905 BELLA POULIN 1994
In loving memory

Marker Stone:

(R7#140)

In memory of
MONIQUE C. LECLERC
1930 - 1992

West Face:

1884 LEONTINE MARTEL 1982

(R7#141) Caron Monument

North Face:

CARON

South Face:

FREDERICK CARON

1866 - 1933

son epouse

ALICE GAMACHE

1867 - 1942

leur fille

SADIE A. CARON

1904 - 1996

Marker Stones:

(R7#142)

YVONNE L. CARON

1902 - 1996

(R7#143)

EUGENE F. CARON

1902 - 1974

(R7#144)

ELIZABETH

1897 - 1922

"en repos"

(R7#145)

SADIE A.

(R7#146)

MERE

"en repos"

(R7#147)

PERE

"en repos"

(R7#148) Favreau Monument

East Face:

FAVREAU

West Face:

ANTONIO E. FAVREAU

Nov. 15, 1888 - Dec. 23, 1961

his wife

EMMA M. LEBEL

Dec. 31, 1890 - Oct. 27, 1981

Marker Stone:

(R7#149)

MATHILDA LEBEL

1860 - 1937

(R7#150)

TETU

-

GUERTIN

(R7#151)

CECILE Y. TETU

1911 - 1981

(R7#152) Madden Monument

West Face:

JAMES MADDEN

1858 - 1927

CATHERINE his wife

1860 - 1918

MARY A. DOUGHER

1846 - 1889

MADDEN

East Face:

JANE FAHY

1863 - 1897

Marker Stones:

(R7#153)

JANE

(R7#154)

JAMES

(R7#155)

CATHERINE

(R7#156)

MARY

(R7#157) MARGARET J. MUIR
died
Dec. 1, 1933
Ae. 66 yrs.

(R7#158) MARGARET
wife of
WILLIAM MUIR
died Apr. 4, 1915
Ae. 82 yrs.
Born in County Down, Ireland

(R7#159) JOHN ROONEY
died
Feb. 7, 1888,
Aet. 85 yr.
A native of County Down, Ireland

(R7#160) Dolan Monument

West Face:

ELLEN BRODERICK
wife of
JOHN DOLAN
died Aug. 25, 1874
aged 45 yrs.
My spirit hath rejoiced in God
my saviour
DOLAN

North Face:

JAMES
son of
JOHN & ELLEN
DOLAN.
died June 27, 1878,
aged 17 yrs. 5 mos.

East Face:

BARTHOLOMEW DOLAN
died
Mar. 11, 1888;
Aet. 21 yrs.

South Face:

JOHN DOLAN
died July 2, 1903
Aet. 85 yrs.

Marker Stones:

(R7#161) FATHER
(R7#162) MOTHER
(R7#163) BART.
(R7#164) JAMES
(R7#165) JOHN R. DOLAN
died
Mar. 20, 1884
Ae. 27 yr. 6 mo.

ST. JOHN THE BAPTIST CEMETERY - Range Layout

RANGE #8
Map #1

WEST
ACCESS ROAD

A
C
C
E
S
S
S
O
U
T
H
R
O
A
D

N
O
R
T
H

A
C
C
E
S
S
R
O
A
D
E
A
S
T

Viney
M **19**

Dumais
M **20**

Lemire
M **21**

Jacques
M **22**

Savard
M **17**

Page
M **18**

Majernik
M **16**

Polv...
M **[REDACTED]**

Paradis
M **12**

Peltier
M **[REDACTED]**
(Dwn.)

Regan
M **[REDACTED]**

Leveque
M **10**
(Dwn.)

Marquis
■ **11**

Lebel
M **[REDACTED]**
Cavecchio
M **2**

Renuad
M **3**

Maicangelo
M **4**

Boivert
■ **7**
Concrete
Curbing

Beaulieu Renard
M **8**

Renard
M **9**

Marquis
M **5**

Durocher
M **6**

ST. JOHN THE BAPTIST CEMETERY - Range Layout

RANGE #8
Map #2

WEST
ACCESS ROAD

S
O
U
T
H

A
C
C
E
S
S
R
O
A
D
N
O
R
T
H

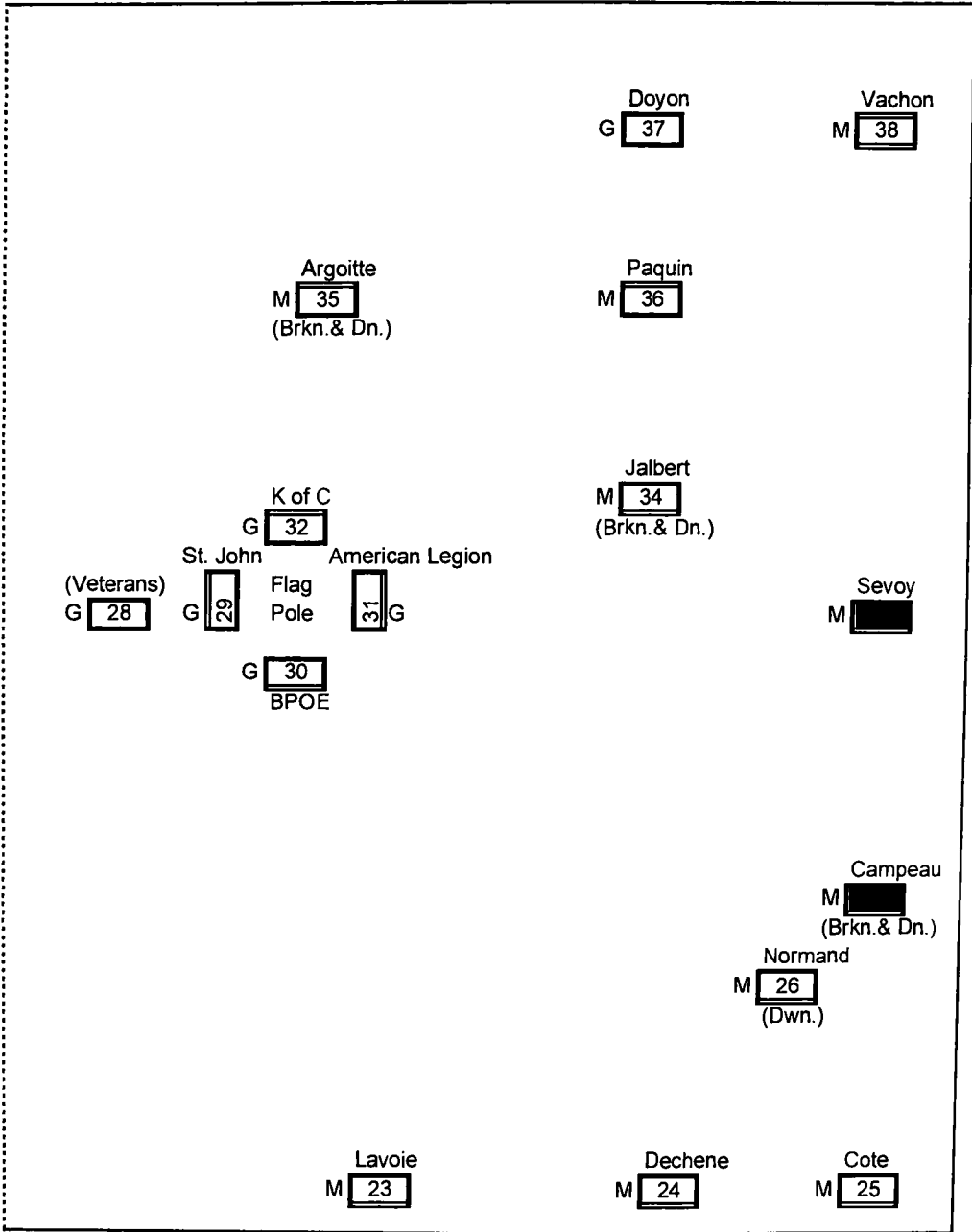

ACCESS ROAD
EAST

RANGE #8

This range contains very few stones for its size and location in the center of the cemetery.

Between the existing stones are a large number of depressions probably indicating unmarked burials.

(R8#1) ALFRED LEBEL
decede
le 1 Mai 1895
a l'age de 34 ans.

(R8#2) ALIANDRO
CAVECCHIO
died
Mar. 16, 1895

(R8#3) Ici
repose le corps
de
ADELINA
enfant de
ANTOINE RENAUD
et de
ODILE DENIS
decedee le 1, Mai 1895
a l'age et 10 mois.

(R8#4) PIETRO
MAICANGELO
died
June 16, 1895

(R8#6) Ici
repose le corps de
ELIZABETH
enfant de
CESALRE DUROCHER
decedee
le 1 Mars 1899
agee de
18 mois et 15 jours

(R8#5) Ici
repose de corps
de
DELIA
epous de
WILLIAM MARQUIS
decedee le 26 Aout
1903 a l'age de
11 mois

(R8#8) Ci - Git
EMILIE COUET
epouse de
ALEXIS BEAULIEU
decedee
le 12 Dec. 1896
agee de 70 ans
R. I. P.

(R8#7) FRANK
died Apr. 3, 1874,
Ae. 10 ys. 8 ms.
OCTAVIE
died Feb. 26, 1874,
AMEDEE BOIVERT
died Aug. 17, 1875,
Ae. 17 ds.
JOS. HAREL
died Dec. 16, 1876,
Ae. 25 ys. 8 ms.

(R8#9)

Ici
repose le corps de
MARIE AIMEE
enfant de
ANTOINE et ODILE
RENARD
decedee
le 5 Decembre 1898
agee de
14 ans et 7 mois
Pries pour elle.

(R8#10)

Enfant de
MAGLOIRE
LEVEQUE
decede le
24 Jul. 1894

(R8#12)

Ici repose
Dame
OLIVER PARADIS
decedee
le 18 Janvier 1892
a l'age de 58 ans
R. I. P.

(R8#11)

Ici repose le corps
de
PIERRE
fils de
GEORGE & HENRIETTE
MARQUIS
decede
le 26 Avril 1893,
age de 3 mois.

(R8#13)

Ici
repose le corps de
VERGENIE PELTIER,
epouse de
AUGUSTUS BARNIER,
decede
le 19 Jan. 1892
agee de 23 ans 10 mois
Quelle repose en paix.

(R8#14)

JNO. REGAN
Co. B.
7 R.I. Inf.

(R8#16)

JOHN MAJERNIK
untar
May 9, 1916

(R8#15)

JOSEPHINE
enfant de
JOS. & POL. WOLE
decede
le 3 Juillet 1889.
age de 17 mois.

(R8#18)

ELIZABETH PAGE
epouse de
MICHEL BARRIBEAU
decede le
2 Fevrier 1871
age de 53 an
Priez pour elle

(R8#17)

Ici
repose le corps de
ZOE SAVARD
epouse de
OCTAVE OPRIL
decedee
le 20 Juillet 1884
a l'age de 50 ans.

(R8#19)

PAULE VINEY
Apr. 16, 1903
Dec. 24, 1903

(R8#20) LUMINA GERMAINE
DUMAIS
enfant de
JOSEPH et ANNA DUMAIS
decedee le 28 Juillet 1905
a l'age de 6 semaines

(R8#21) Priez le repose de corps
de
ERNEST LOUIS LEMIRE
decede de 24 Aout 1903
a l'age de
4 ans 1 mois 21 jour

(R8#22) MARIE LOUISE
fille de
NORCISSE et PAMELA
JACQUES
decedee
.....

(Stone badly weathered)

(R8#23) Ici repose le corps de
HELENA
enfant de
LETUS LAVOIE
decede
le 25 Decembre 1906
a l'age de 13 ans. 3 mois
Priez pour elle

(R8#24) Ici repose
JOSEPH H.
fils de JOSEPH DECHENE
ne a St. Aubert,
le 15 Juillet 1874
decede a Brunswick
le 6, June 1896
a l'age de 21 ans. 10 mois
22 jours.
R. I. P.

Ici repose
MARIE AUXILIA
fille de JOSEPH DECHENE
ne a St. Aubert,
le 20, Oct. 1875
decede a Brunswick
le 29, Mars. 1892
a l'age de 16 ans 10 mois

(R8#25) Ici repose le corps de
VIRGINIE COTE
epous de
ISRAEL BERGER
1869 - 1891

(R8#26) A la memoire de
LARENZO
decede
le 22 Septembre 1897
agee de 17 jours
et
ALBERT
decede
le 25 Octobre 1900
agee de 5 ans
enfants bien aime de
..... NORMAND

(R8#27) Ici repose le corps de
ARTHEMISE CAMPEAU
epouse de
ALFRED RUTELLE
decede
le 24 Mars 1892
a l'age de 17 ans
Priez pour elle

(Stone broken & down)

(Stone down)

Stones surrounding the flagpole:

- (R8#28) Dedicated (R8#29) St. John the Baptist
to our veterans Cemetery
by the grateful citizens Father Remy Circle #508
of Brunswick Daughters of Isabella
- (R8#30) B.P.O.E. (R8#31) American Legion
To our absent brothers Post 202
- (R8#32) Knight's of Columbus V.F.W. U.S. D.A.V.
Sekencer Council No. 1947 Post 2197 American Chapter 15
Rev. William L. Dauphin S. M. Assembly Veterans of Legion Disabled
Foreign Wars Topsham American
U.S. Veterans
- (R8#33) KATIE SEVOY (R8#34) A la memoire de
died GEORGE JALBERT
Dec. 13, 1891 epoux de
Ae. 10 ys. DEMERISE BOUCHER
decede le 7 Oct. 1888
age de 47 ans et 7 mois
- (R8#35) Ici (Stone broken & down)
OLIVE ARGOITTE
epouse
ALCIDE (LEMIEUX)
dec(ede)
(le 30 Juillet 1887)
(age de 23 ans et 10 mois)
- (R8#36) ARMAND
enfant de
J. H. PAQUIN
decede
le 7, Juillet 1900
a l'age de 7 ans
et 1 jour.
- (R8#37) ANNE MARIE L.
DOYON
1914 - 1915
- (R8#38) East Face: (R8#38) West Face:
ALPHONSE VACHON STANISLAS
enfant de
SARAH et LUDDWIN
VACHON
decede le 27 Mars 1...
age de 3 ans et 8 mois

**ST. JOHN THE BAPTIST CEMETERY
PINE STREET & BATH ROAD
BRUNSWICK, MAINE**

CUMBERLAND COUNTY

**Volume 2 of 3
Ranges 9 through 17**

Donald & Mark Cheetham, 2007 - 2009

.CS15
Stj
2009
v. 2

St. John the Baptist Cemetery

St. John the Baptist Cemetery is located between Pine Street and Bath Road in Brunswick, Cumberland County, Maine and is known by most simply as St. John's Cemetery. It is situated on the north side of Pine St. and the south side of Bath Rd. bordered by the Brunswick Naval Air Station on the east side and Varney Cemetery on the west side. The cemetery consists of 3,643 stones, the earliest dated 1854, is completely fenced and is still very active. A flagpole is situated near the center of the cemetery and about its base are stones representing the cemetery, the citizens of Brunswick, Elks, American Legion and Knights of Columbus. A maintenance building is located off Pine Street and the Ste. Marie family crypt is located near the center of the cemetery.

This record of St. John the Baptist Cemetery is dedicated to Judy Souther, the sextant of St. John the Baptist Church and caretaker of this cemetery, in recognition of the improvements she is making to these hallowed grounds as well as the valuable assistance she provided in connection to this record.

Contents

Volume 1 of 3 (Range 1 through 8)

- 1) Map illustrating the general arrangement of the cemetery.
- 2) Maps indicating the numbering of the ranges and detail maps.
- 3) Detail maps indicating the placement of the individual stones and markers by range.
- 4) Record of each individual stones inscription.

Volume 2 of 3 (Range 9 through 17)

- 5) Detail maps indicating the placement of the individual stones and markers by range.
- 6) Record of each individual stones inscription.

Volume 3 of 3 (Range 18 through 20)

- 7) Detail maps indicating the placement of the individual stones and markers by range.
- 8) Record of each individual stones inscription.
- 9) Additional cemetery burials.
- 10) Translations
- 11) Index by family name giving the location in the cemetery corresponding to the maps and text.

Note

Numbering of the markers is only as an aid in locating the stone within the context of this survey and do not represent any town or cemetery association designation.

Detail maps indicate monuments and marker stones by a dark outline. A double line indicates the side of which the marker stone or monument is inscribed. No double line indicates that the inscription is on the top surface of the stone.

Type of marker, be it Marble, Granite, Metal or Concrete is indicated on the detail maps for the cemetery. M = Marble, G = Granite, Mtl. = Metal, Conc. = Concrete.

This record of St. John the Baptist Cemetery was produced by Donald Cheetham of Brunswick, Maine and Mark Cheetham of Richmond, Maine 2007 - 2009.

ST. JOHN THE BAPTIST CEMETERY - Range Layout

RANGE #9
Map #1

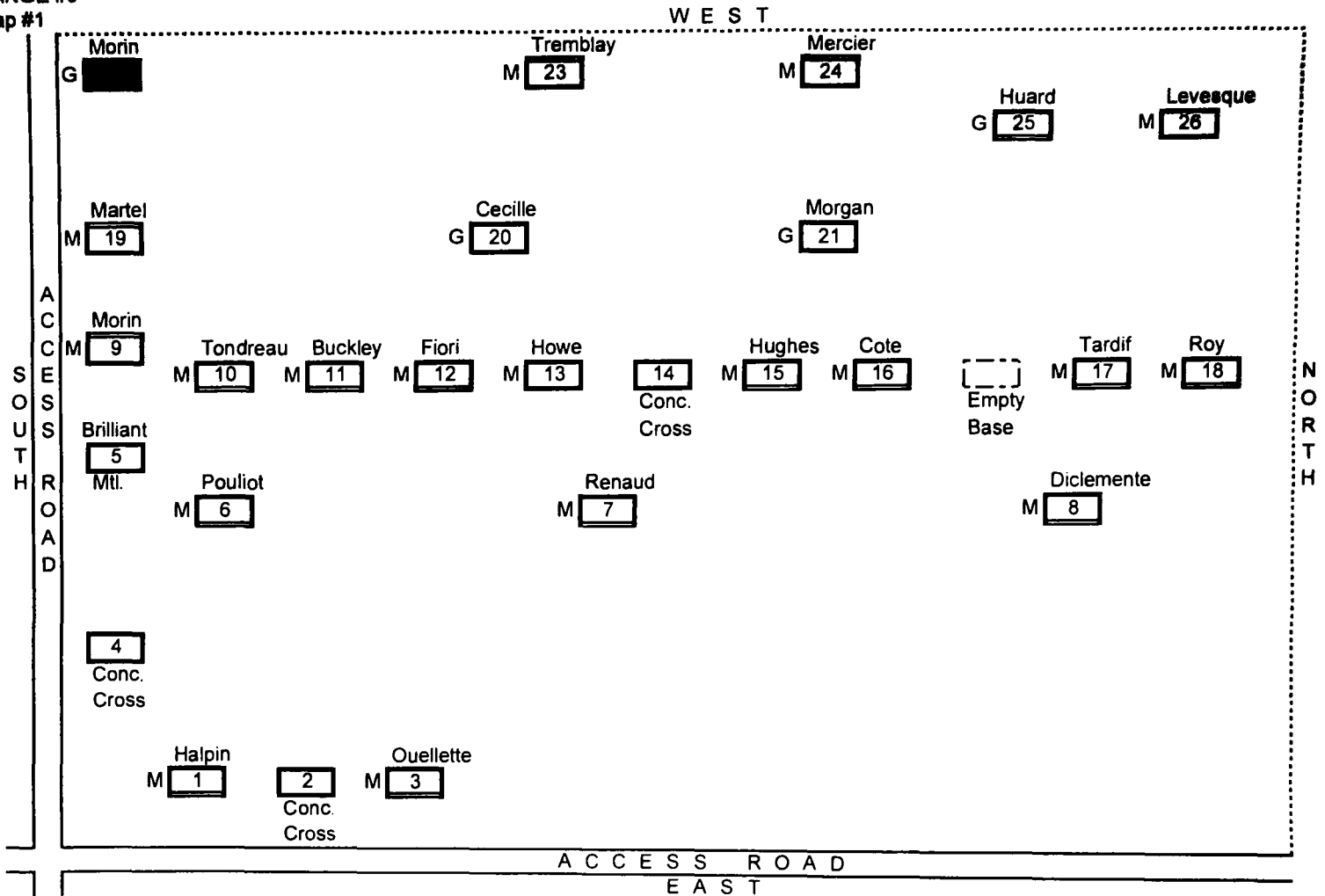

ST. JOHN THE BAPTIST CEMETERY - Range Layout

Range #9
Map #2

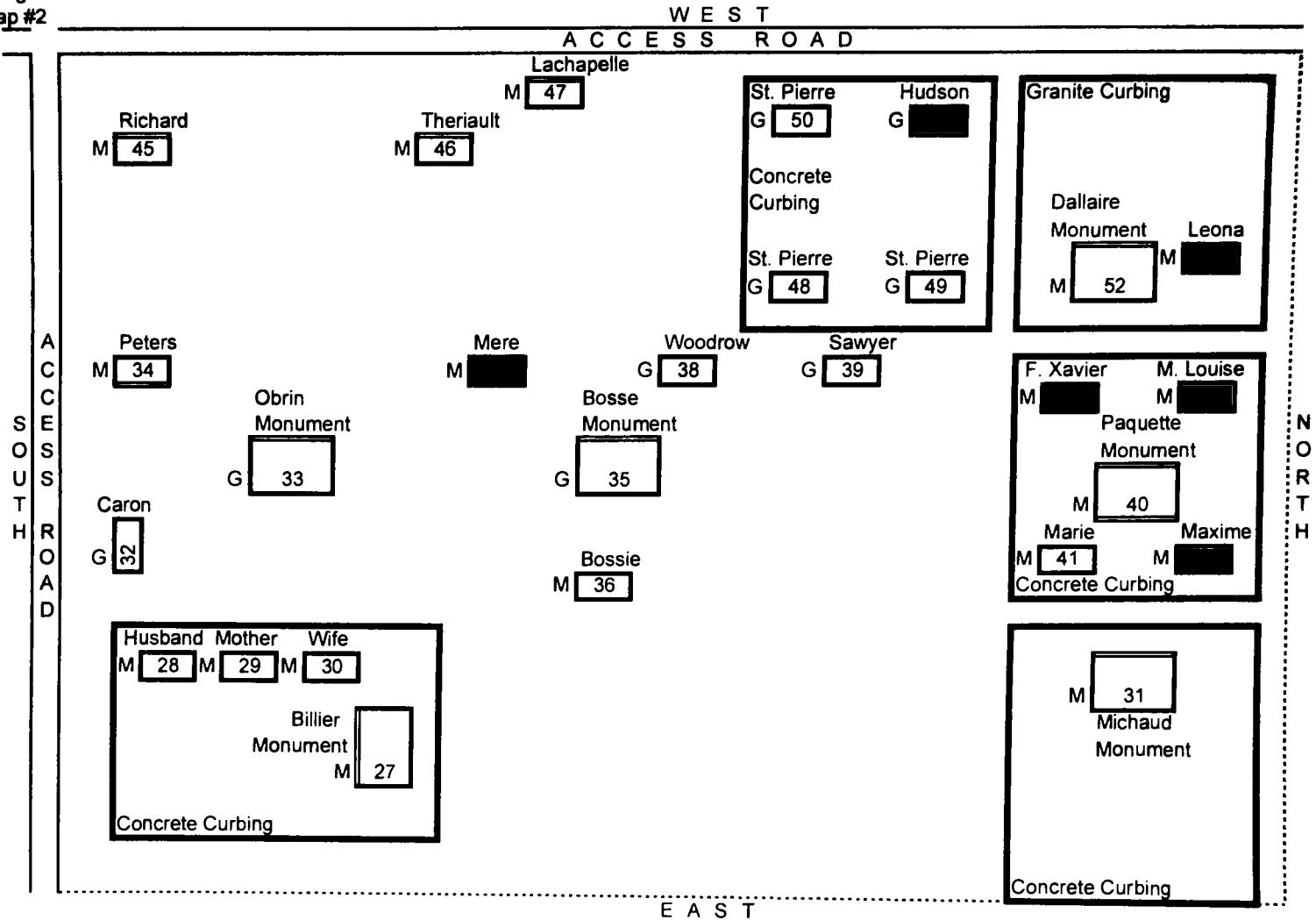

ST. JOHN THE BAPTIST CEMETERY - Range Layout

RANGE #9
Map #3

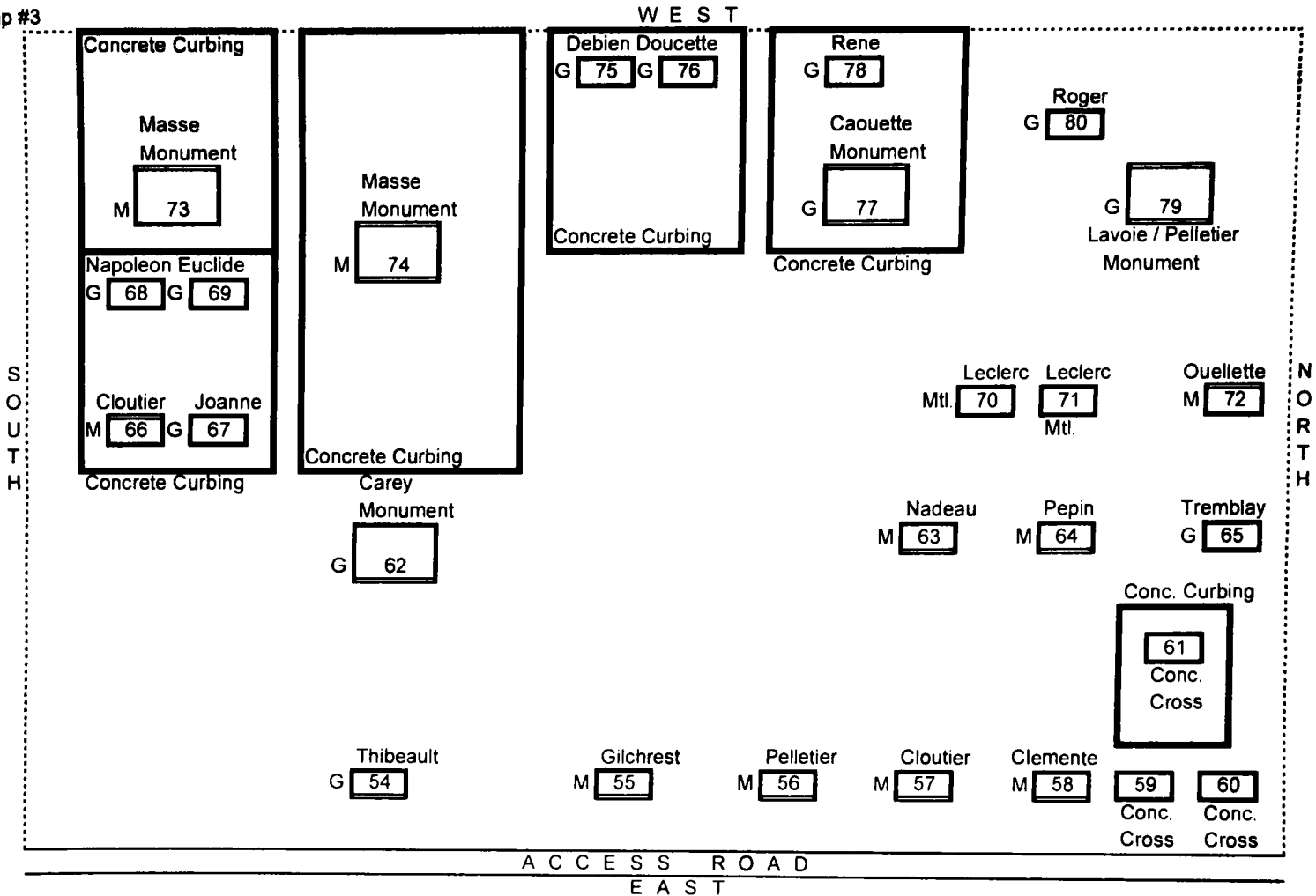

ST. JOHN THE BAPTIST CEMETERY - Range Layout

RANGE #9

Map #4

W E S T
A C C E S S R O A D

Pere Mere

Mere Pere
G 88 G 89

Bernier
Monument
G 87

Granite Curbing

Epouse Epoux
G 91 G 92

Richard
Monument
G 90

Granite Curbing

Beauchene Beauchene
G 97 98 99 100
G M M G

Allard
Monument
M 93

Lucille
G 102 G 103
Father /
Mother

Bisson
Monument
G 101

Granite Curbing

Tetreault
M 106

Blanche
G 107

Dionne /
Tetreault
Monument
G 104

Dionne
G 105

Pere Therese Mere
M 94 M 95 M 96

Levesque
Monument
G 81

Beaudoin
Monument
M 82

Bureau
Monument
M 85

Saucier
Monument
G 86

Dora Raymond
G 83 G 84

S
O
U
T
H

N
O
R
T
H

E A S T

ST. JOHN THE BAPTIST CEMETERY - Range Layout

RANGE #9
Map #5

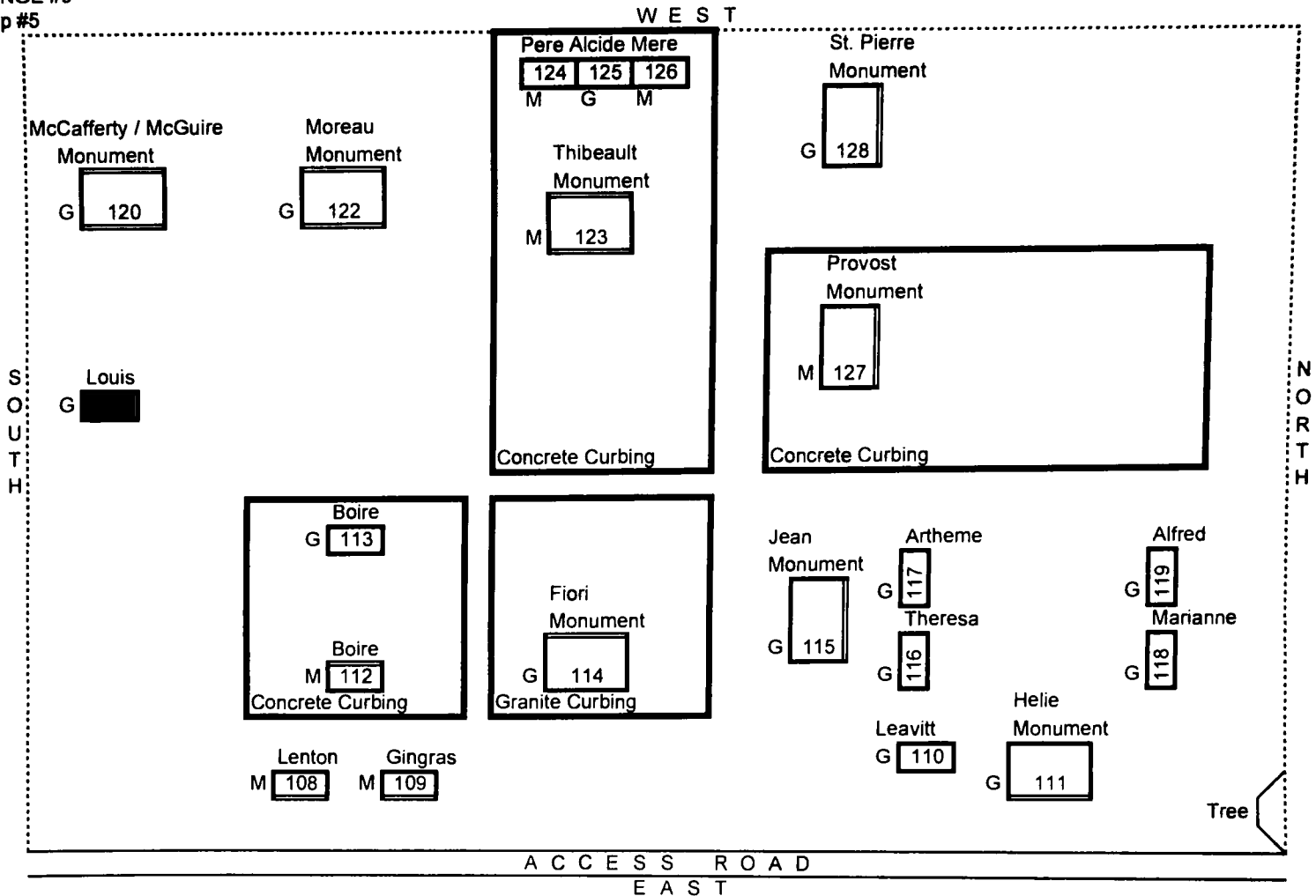

ST. JOHN THE BAPTIST CEMETERY - Range Layout

RANGE #9
Map #6

WEST
ACCESS ROAD

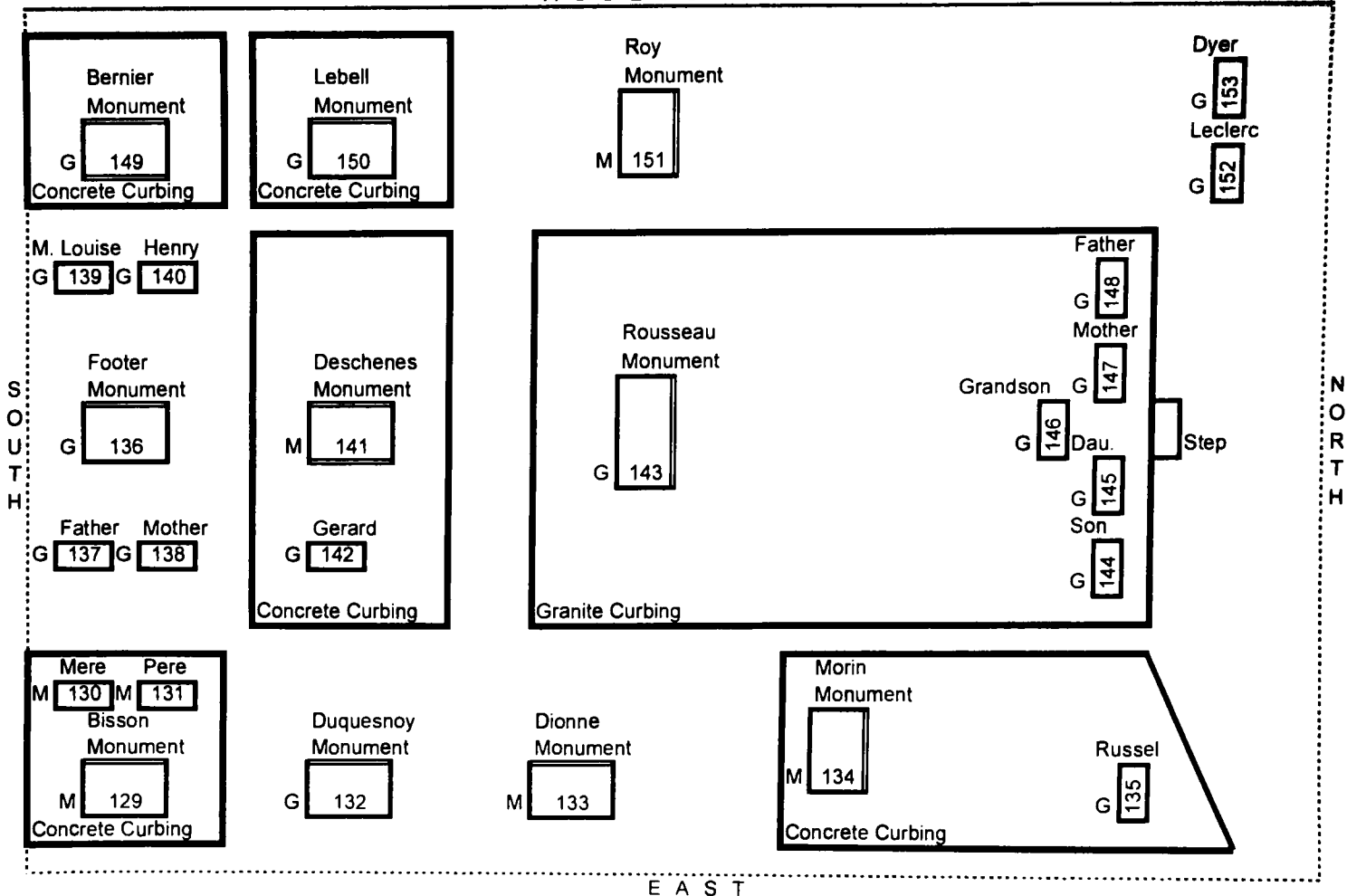

ST. JOHN THE BAPTIST CEMETERY - Range Layout

RANGE #9

Map #7

W E S T

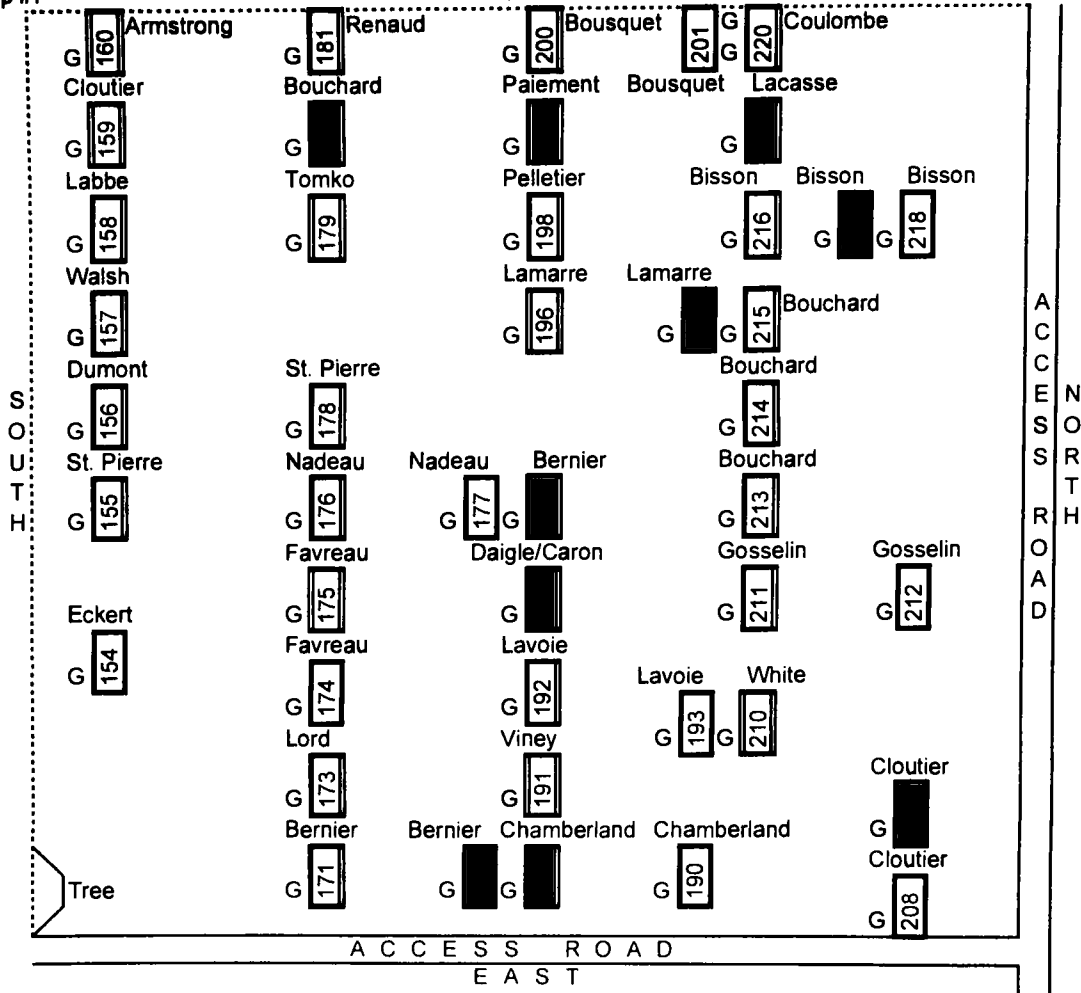

A C C E S S R O A D

A C C E S S R O A D
E A S T

ST. JOHN THE BAPTIST CEMETERY - Range Layout

RANGE #9
Map #8

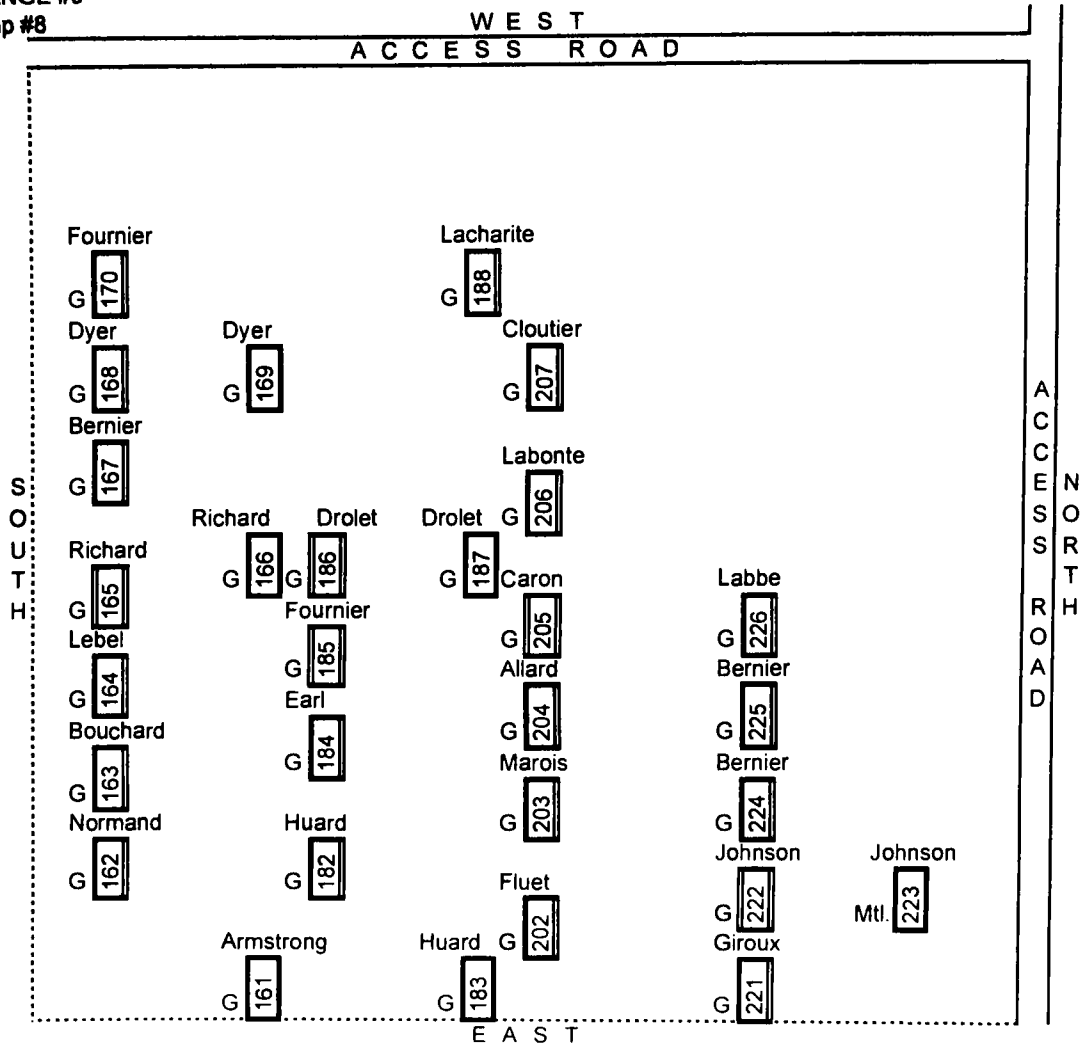

RANGE #9

- (R9#1) SUSAN A. HALPIN
died
HARPSWELL, Me.
Dec. 19, 1907
- (R9#2) (Concrete cross
with no inscription)
- (R9#4) (Concrete cross
with no inscription)
- (R9#5) EDWARD BRILLIANT
1869 - 1935
- (R9#7) Ici repose le corps de
ANTOINE RENAUD
decede
le 21 Dec. 1912
a l'age de 58 ans.
- (R9#9) JOSEPH MORIN
1857 - 1932
EXZILDA ST. PIERRE
epouse de
JOSEPH MORIN
nee 20 Juillet 1863
decedee 25 Juillet 1929
at age de 66 ans.
- (R9#12) FRANK FIORI
1876 - 1937
- (R9#14) (Concrete cross
with no inscription)
- (R9#3) Ici
repose le corps de
MARGUERITE OUELLETTE
epouse de
DAMIEN THIBODEAU
decedee le
13 Dec. 1908
age de 52 ans.
- (R9#6) ARTHUR POULIOT
son of EDMOND &
APOLLINE POULIOT
1896 - 1912
- (R9#8) MADALENA
DICLEMENTE
died April 1915
Ae. 88 ys.
Qui repose
- (R9#10) ROSE A. TONDREAU
died Aug. 15, 1935
- (R9#11) JOHN D. BUCKLEY
1861 - 1930
- (R9#13) MARGARET
W. HOWE
1869 - 1941
- (R9#15) ALPHONSE HUGHES
decede
le 13 Juillet 1928
a l'age de 57 ans.

(R9#16) DELEMA CASISTA
epouse de
ALBERT COTE
nee le 2 Avril 1865
decedee 3 Aout 1928

(R9#17) Ici repose le corps de
ROLAND TARDIF
fils de
A. TARDIF et de J. OUELLET
decede
le 23 Sept. 1929
a l'age de 8 ans 4 mos

(R9#18) Ici repose le corps de
LOUIS ROY
epoux de
EVA ROUSSEAU
ne 5 Avril 1903
decede le 10 Juin 1931

(R9#19) CECILE MARTEL
1877 - 1932
epouse de
ALFRED LABBE

(R9#20) CECILLE

(R9#21) MORGAN
CHARLES Together AMANDA
1862 - 1939 forever 1882 - 1972

(R9#22) VIRGINIE MORIN
1864 - 1932
epouse de
WILLIAM
DESJARDINS

(R9#23) JOSEPH TREMBLAY
1864 - 1936
son epouse
ELMIRE TREMBLAY
1866 - 1936
TREMBLAY

(R9#24) XAVIER MERCIER
1865 - 1939
DOMITILDE his wife
1867 - 1907
GELENIRE 1892 - 1938
MARIE ANNE 1897
MERCIER

(R9#25) MARIE HUARD
Mar. 19, 1904 May 22, 1988
ELISE LEVESQUE her aunt
July 25, 1879 Sept. 28, 1968

(R9#26) JOSEPH
LEVESQUE

(R9#27) Billier Monument

IHS
WILLIE D. BILLIER
1890 - 1932
GRACE NADEAU his wife
1892 - 1983
MEDDIE BELAND
1851 - 1942
BILLIER

Marker Stones:

(R9#28) HUSBAND
At rest
(R9#29) MOTHER
At rest
(R9#30) WIFE
At rest

(R9#31) Michaud Monument

LUDGER MICHAUD
1866 - 1939
son epouse
MARIE GODBOUT
MICHAUD

(R9#32)

CARON
FRED **EMILE** **YVONNE**
1889 - 1967 1866 - 1933 **OUIMET**

(R9#34)

GILBERT PETERS

(R9#33) Obrin Monument

OBRIN
STEVE J. Jr.
Jan. 10, 1943
THERESE BONENFANT wife
Dec. 22, 1942 - Nov. 5, 2003
Loved by all that knew her
Sadly missed by those she left behind

his wife
BARBARA MacDONALD
1867 - 1934
PETERS

(R9#35) Bosse Monument

ULYSSES BOSSE
1894 - 1983
son epouse
a'la douce memoire de
AMANDA CASTONGUAY
1892 - 1935
BOSSE

Marker Stones:

(R9#36) VIRGINIA BOSSE
16 May 1934
25 Sept. 1935
(R9#37) MERE
(R9#38) WOODROW J BOSSE

(R9#39)

CYCLONE
JAMES F. SAWYER
Oct. 8, 1912 - June 15, 1935

Maine
Cpl US Army
June 29 1929 Aug 22 1960

(R9#40) Paquette Monument

East Face:

MAXIME PAQUETTE
1869 - 1940
son epouse
MARIE LABBE
1862 - 1936
PAQUETTE

West Face:

IHS
F. XAVIER DURAND
1862 - 1939
son epouse
M. LOUISE LABBE
1872 - 1947

Marker Stones:

(R9#41) **MARIE**

(R9#42) **MAXIME**

(R9#43) **F. XAVIER**

(R9#44) **M. LOUISE**

(R9#45) **MARCEL RICHARD**
1866 - 1941
son epouse
ALPHONSINE
LACHANCE
1868 - 1935
RICHARD

(R9#46) **SOPHIE F.**
THERIAULT
1883 - 1936

(R9#47) **FRANK LACHAPELLE**
1869 - 1946
son epouse
AZILDA BONBARDIER
1873 - 1935

(R9#48) **Pere**
ALBERT A. ST. PIERRE
1884 - 1937

(R9#50) **LEOPOLD**
1914 - 1935

(R9#49) **Mere**
MAUDE R. ST. PIERRE
1887 - 1953

(R9#51) **MARION M. HUDSON**
1881 - 1944

(R9#52) **Dallaire Monument**
HIPPOLYTE DALLAIRE
1845 - 1927

Marker Stone:
(R9#53) **LEONA**

(R9#54) **DELVINA**
THIBEAULT
1870 - 1941

(R9#55) **IHS**
MARY A.
wife of
BENI. G. GILCHREST
1869 - 1912

(R9#56)

Ici repose de corps
DIRENEE
fils DONESIMIE PELLETIER
decede le 27 Mai 1915
a l'age de 29 ans 10 mois
R. I. P.

(R9#57)

Pere
ZEPHIRIN CLOUTIER
decede
le 8 Juillet 1915
a l'age de 54 ans
9 mois

(R9#58)

FRANK De CLEMENTE
died Feb. 8, 1918
Ae. 52 ys.

(R9#59)

(Concrete cross
with no inscription)

(R9#60)

(Concrete cross
with no inscription)

(R9#61)

(Concrete cross
with no inscription)

(R9#62)

Carey Monument
NELLIE J. CAREY
wife of
JAMES L. DAY
1861 - 1933

(R9#63)

MARIE NADEAU
1911 - 1934

(R9#64)

DELINA
PEPIN
1865 - 1935

(R9#65)

Father
LOUIS TREMBLAY
1883 - 1939

(R9#66)

CLOUTIER

Marker: U.S. Veteran

(R9#67)

JOANNE CLOUTIER
daughter of
FERDINAND and ANITA CLOUTIER
April 28, 1959 March 22, 1961

(R9#68)

NAPOLEON CLOUTIER
Feb. 3, 1873
June 26, 1939

(R9#69)

EUCLIDE A CLOUTIER
Maine
PHOM2 USNR
World War II
June 2, 1905 Oct 7 1945

(R9#70)

ANNA LECLERC
1862 - 1943

(R9#71)

FRANCOIS
LECLERC
1854 - 1940

(R9#72)

OUELLETTE
1880 LEON 1940
his wife
CLARA COULOMBE
1881 - 1921

(R9#73) Masse Monument
FLORIAN MASSI
1879 - 1940
son epouse
EUGENIE DION
1886 - 1967
MASSE

(R9#74) Masse Monument

West Face:

ARTHUR MASSE
1866 - 1940
son epouse
ROSANNA TARDIF
1873 - 1956
MASSE

East Face:

MASSE
FELIX MASSE
1907 - 1969
son epouse
CLAIRE CARON
1907 - 1987

(R9#75)

JOSEPH O. DEBIEN
1884 - 1940

(R9#76)

BENJAMIN R. DOUCETTE
1885 - 1960
son epouse
MARIE ANNE GAUDREAU DESBIENS
1889 - 1961

(R9#77) Cauotte Monument

West Face:

CAOUETTE
Jesus Marie Joseph

East Face:

DAMASE CAOUETTE Jr.
1883 - 1964
son epouse
EVA C. CAOUETTE
1888 - 1975
PHILOMENE LEVESQUE
1849 - 1939
epouse de
DENIS LEVESQUE

Marker Stone:

(R9#78)

RENE CAOUETTE
US Air Force
June 22 1914 Jan 10 1988

Marker: U.S. Veteran

(R9#79) Lavoie / Pelletier Monument

West Face:

LAVOIE
PELLETIER

East Face:

JEAN BAPTISTE LAVOIE
Sept. 14, 1894 - Dec. 23, 1950
SYLVIO son
July 21, 1920 - Apr. 27, 1939
MARIE PELLETIER Granddaughter

Marker Stone:

(R9#80)

ROGER G. PELLETIER
SP5 US Army
Vietnam
Feb 22 1945 Jul 25 2003

ROGER G. PELLETIER
Feb. 22, 1945 - July 25, 2003
PATRICIA T. his wife
Jan. 2, 1954

(R9#82) Beaudoin Monument

West Face:

ALBERT BEAUDOIN
1892 - 1979
son epouse
MARIE F. GARAND
1898 - 1951
MARY - 1936
BEAUDOIN

(R9#81) Levesque Monument

West Face:

LEVESQUE

Our father which art in heaven

East Face:

BERTRAND J. LEVESQUE
Apr. 29, 1923 June 23, 1996
his wife
JEANNE D'ARC BRILLANT
July 19, 1922 Oct. 10, 1989
ALPHONSE LEVESQUE
1869 Feb. 14, 1946
MARY LEVESQUE
June 9, 1884 Oct. 11, 1954

East Face:

RAYMOND A.
1918 - 1968
son epouse
DORA J.
1915 - 1994

Marker Stones:

(R9#83)

DORA J BEAUDOIN
wife of
RAYMOND A BEAUDOIN
Apr 8 1915 July 2 1994

(R9#84)

RAYMOND A BEAUDOIN
Maine
S2 USNR
World War II
Nov 10 1918 March 10 1994

(R9#85) Bureau Monument

West Face:

ZEPHIRIN BUREAU
1881 - 1937
son epouse
MARIE COUTURE
1885 - 1948
ARTHUR leur fils
1910 - 1934
BUREAU

East Face:

THERESE
1925 - 1993
ARLINE B.
1921 - 2006

(R9#86) Saucier Monument

West Face:

SAUCIER

Say an Our Father

East Face:

LEZIM O. SAUCIER

May 15, 1878 Mar. 19, 1943

MAXITE F. PELLITIER his wife

Nov. 21, 1878 Feb. 3, 1952

ALCIDE their son

Feb. 28, 1906 Oct. 29, 1937

OMER their son

June 9, 1914 July 9, 1941

J. O. ROGER his son

July 24, 1940 July 9, 1941

(R9#87) Bernier Monument

**IHS
BERNIER**

Marker Stones:

(R9#88)

Mere
CORINNE POMERLEA
epouse de
DAVID BERNIER
1906 - 1935

(R9#89)

Pere
DAVID C. BERNIER
1904 - 1991

(R9#90) Richard Monument

RICHARD

Marker Stones:

(R9#91)

Epouse
MARIE L. RICHARD
1885 - 1936

(R9#92)

Epoux
J. B. EUSTACHE RICHARD
1875 - 1953

(R9#93) Allard Monument

JOSEPH ALLARD

1874 - 1937

son epouse

AMANDA BERGERON

1872 - 1938

ALLARD

Marker Stones:

(R9#94)

PERE

(R9#95)

THERESE

(R9#96)

MERE

Marker: U.S. Veteran

(R9#97)

ARMAND L BEAUCHENE

PFC US Army

World War II

May 16 1916 Dec 26 2006

(R9#98)

PERE

(R9#99)

MERE

(R9#100)

YVETTE J BEAUCHENE
Dec 13 1913 Dec 12 2004

(R9#101) Bisson Monument

1892 ARTHUR BISSON 1976

son epouse

1893 ODILE HELIE 1976

leur fille

1914 LUCILLE PERREAULT 1937
BISSON

Marker Stones:

(R9#102)

LUCILLE

(R9#103)

Father : Mother
ARTHUR : ODILE
1892 - 1976 : 1893 - 1976
In loving memory

(R9#104) Dionne / Tetreault Monument

West Face:

DIONNE

-

TETREAULT

East Face:

CYPRIEN JOSEPH DIONNE

June 14, 1893 Sept. 10, 1937

his wife

BLANCHE A. B. DIONNE TETREAULT

Feb. 3, 1901 June 21, 1987

her husband

LOUIS JOSEPH TETREAULT

July 18, 1903 June 10, 1982

Marker Stones:

(R9#105)

JOSEPH

CYPRIAN

DIONNE

-

Maine

-

Pvt 1 Cl. 74 Inf.

12 Div.

September 10, 1937

Marker: U.S. Veteran

(R9#106)

LOUIS JOSEPH

TETREAULT

July 18, 1903 - June 10, 1982

(R9#108) JOHN J. LENTON

1851 - 1923

(R9#107)

Wife

BLANCHE A. BERNIER

DIONNE TETREAULT

Feb. 3, 1901 June 21, 1987

(R9#109) GEORGE F.

GINGRAS

decede

le 12 Aout 1925

a l'age de 51 ans.

(R9#110)

Son of

Mr. & Mrs. EARL LEAVITT

ALBERT R. LEAVITT

Oct. 7, 1931

July 6, 1932

(R9#111) Helie Monument

IHS

MAXINE F. HELIE

1875 - 1927

son epouse

EVANGELINE HOULE

1877 - 1965

(R9#112) **BOIRE**

(R9#113) **PHILIAS J. AMANDA P.**
1899 - 1983 1902 - 1941
BOIRE

(R9#115) **Jean Monument**

JEAN

Requiescant in pace

Marker: U.S. Veteran

Marker Stones:

(R9#116) **THERESA JEAN
BELANGER**
1896 - 1954

(R9#117) **ARTHEME M BELANGER**
Maine
Bugler Co A 101 Engrs 26 Div
World War I PH
April 13 1894 Jan 1 1955

(R9#114) **Fiori Monument**

IHS

1880 **ALFRED FIORI** 1951
his wife
1882 **CAROLA ADAMI** 1940
FIORI

(R9#120) **McCafferty / McGuire Monument**

East Face:

McCAFFERTY
EDITH M. LOUIS A.
June 30, 1918 June 22, 1919
June 18, 1983

Marker: U.S. Veteran

West Face:

McGUIRE
ANNASTACIA C. ALLEN G.
Apr. 1, 1886 Aug. 28, 1876
Jan. 16, 1941 Apr. 20, 1943

Marker Stone:

(R9#121) **LOUIS A McCAFFERTY**
TSgt US Army
World War II
Jun 22 1919 Jun 18 1983

(R9#122) **Moreau Monument**

East Face:

MOREAU
FLORIEN J. ANTOINETTE M.
Feb. 13, 1913 July 5, 1915
Mar. 21, 1992 Sept. 24, 1999

West Face:

MOREAU
ROSE ANNA TREFFLE
Apr. 10, 1886 Jan. 26, 1882
Mar. 23, 1941 Apr. 16, 1940

(R9#123) **Thibeault Monument**

West Face:

IHS
THIBEAULT

East Face:

1879 **WILFRED H. THIBEAULT** 1940
son epouse
1880 **LAURA RACINE** 1950
1910 **ALCIDE THIBEAULT** 1989
V.M.Co.

Marker Stones:

(R9#124) PERE

(R9#126) MERE

(R9#125)

ALCIDÉ THIBEAULT
PFC US Army
World War II
May 9 1910 Feb 25 1989

(R9#127) Provost Monument

Mother - Father
HENRIE J. PROVOST
1884 - 1940
his wife
ADELE J. JACQUES
1886 - 1955

(R9#128) St. Pierre Monument

ST. PIERRE
HENRY YVONNE
1903 - 1954 1903 - 1985

(R9#129) Bisson Monument

ADELARD BISSON
1898 - 1939
son epouse
ALMA DIONNE
1898 - 1958
BISSON

(R9#132) Duquesnoy Monument

DUQUESNOY
1911 GEORGE E. 1981
1907 wife IDA 1980
1873 GEORGE L. 1939
1877 wife AUGUSTINE 1958

Marker Stones:

(R9#130) MERE

(R9#131) PERE

(R9#133) Dionne Monument

IHS
DIONNE
1898 HORMIDAS DIONNE 1939
son epouse
1897 ALDERIE PASCAL 1971
1923 ROMEO DIONNE 1939
1897 ZORILDA FORTIER 1975

(R9#134) Morin Monument

MORIN
U.S. Army - Spanish American War
LORENZO E. MORIN
1876 - 1947
son epouse
EUGENIE LEBEL
1873 - 1938

(R9#135)

RUSSELL
Husband Married ISABELLE
CHARLES P. Nov. 19, MORIN
1909 - 1993 1942 1910 - 1995

(R9#136) Footer Monument

IHS
FOOTER

Marker Stones:

(R9#137)

Father
JOSEPH E.
1868 - 1938

(R9#138)

Mother
MARY M.
1865 - 1942

Marker Stones Cont'd.

(R9#139) M. LOUISE
KERRIGAN
1899 - 1988

(R9#140) HENRY
1906 - 1986

(R9#141) Deschenes Monument

East Face:

RAYMOND DESCHENES
1920 - 1939
GERARD G.
1921 - 2002
his wife
MARIE A.
1919 -

West Face:

JOSEPH DESCHENES
1881 - 1938
son epouse
JEAN BOIS
1886 - 1963

Marker: U.S. Veteran

Marker Stone:

(R9#142) GERARD GEORGE DESCHENES
BM2 US Navy
World War II
Dec 29 1921 Feb 3 2002

(R9#143) Rousseau Monument

ROUSSEAU

Marker Stones:

(R9#144) LAURIER G.
Son
1908 - 1989

(R9#145) YOLANDE R. DRAPEAU
Daughter
1902 - 1996

(R9#146) JEROME DRAPEAU
Grandson
1925 - 2000

(R9#147) DORILDA O.
Mother
1874 - 1954

(R9#148) JOSEPH HONORE
Father
1873 - 1940

(R9#149) Bernier Monument

West Face:

BERNIER

East Face:

THEOPHILE

1892 -

his wives

FLORIDA BERNIER

1895 - 1937

ANNA MACKOVJAK

1903 -

(R9#150) Lebell Monument

LEBELL

1916 **DANIEL H.** 1937

1891 **ALMA** 1964

1885 **J. ANTHONY** 1952

(R9#151) Roy Monument

CAMILLE ROY

1881 - 1942

son epouse

MARIE R. BOUCHER

1886 - 1938

(R9#152)

Father

ERNEST L. LECLERC

1895 - 1978

(R9#154)

JULIE ANN ECKERT

Feb. 20, 1967 - June 7, 1972

Budded on earth

to bloom in heaven

(R9#153)

KENNETH J. DYER

1958 - 1978

son of

JOHN & IRENE

(R9#155)

ST. PIERRE

1914 **NAPOLEON L.** 1986

his wife

RITA M. 2000

(R9#156)

DUMONT

JANICE C. :

1931 - 1972 :

(R9#158)

IHS

LABBE

CLAIRE EDWIN

1916 - 1972 1915 -

(R9#157)

WALSH

DOROTHY F. ADAM J

1904 - 1972 1901 - 1985

(R9#160) South Face:

ARMSTRONG

ANN L.

1967 - 1973

Infant baby **ROBERT Jr.**

BETTY A. ROBERT T.

1944 - 1938 - 1972

North Face:

In loving memory

ROBERT T. BETTY A.

(R9#159) North Face:

CLOUTIER

"PHIL" JEANNE

South Face:

THEOPHILE A. CLOUTIER

May 18, 1937 - Apr. 7, 1990

his wife

JEANNE A. MOORE

Oct. 3, 1939 -

(R9#161) **ROBERT T ARMSTRONG**
Massachusetts
SN US Navy
Jan 7 1938 July 11 1972

(R9#162) **NORMAND**
CLAUDIA :
1892 - 1986 :

(R9#163) **BOUCHARD**
J. REMI THERESA V.
1926 - 1928 -

(R9#164) **LEBEL**
1903 MARIE ANNA 1972

(R9#165) North Face:
RICHARD
South Face:
1906 FREDERICK J. 1972
1902 EVA C. 1997
1915 MARGUERITE M. 2002

(R9#166) **FREDERICK J RICHARD**
Maine
Pvt 283 QM Refrg Co
World War II
Nov 24 1906 Jan 30 1972

(R9#168) **DYER**
Father Mother
JOHN R. IRENE P.
1931 - 2004 1938 - 1971
In loving memory

(R9#167) **BERNIER**
1895 ADELARD J. 1972
his wife
CECILE THIBEAULT
1910 1992
In loving memory

(R9#169) **JOHN R DYER**
Sgt US Marine Corps
Korea
Sep 1 1931 Oct 4 2004
Marker: U.S. Veteran

(R9#170) **FOURNIER**
1930 PAUL A. FOURNIER
his wife
1933 MURIEL M. GREGOIRE
In loving memory

(R9#172) **LEON A BERNIER**
TSgt US Army
World War II
Mar 8 1919 Jul 17 1984

(R9#171) **BERNIER**
LEON A. :
1919 - 1984 :

(R9#173) **LORD**
1906 ALBERT 1972 1908 CELESTINE 1993

Marker: U.S. Veteran

(R9#174) FAVREAU
CHRISTOPHER DONAT
Jan. 15, 1972
Jan. 16, 1972

(R9#175) North Face:
Beloved mother
YVETTE M. FAVREAU
Aug. 20, 1922
May 22, 1994

(R9#176) NADEAU
FLAVIEN E. LILLIAN M.
1922 - 1975 1927 -
My Jesus mercy

South Face:
Footprints
the Lord replied
I love you and would never leave you
during your times of trial and suffering
when you see only one set of footprints
it was then that I carried you.

(R9#177) FLAVIEN E NADEAU
PFC US Army
World War II
1922 1975

(R9#178) ST. PIERRE
In loving memory
LEO A. LUCIE L.
1915 - 1972 1911 - 2003

(R9#179) South Face: North Face:
TOMKO 1912 ANDREW J. TOMKO 1978
his wife
1914 MARIE Z. RACINE 1972
1936 RICHARD P. TOMKO
his wife
1941 ELIZABETH M. ORNE

(R9#180) BOUCHARD
1885 ARTHUR J. 1971 1885 ALPHONSINE 1974

(R9#181) RENAUD
LIONEL J. EVA B.
1912 - 1971 1912 - 1988

(R9#182) HUARD
1903 LOUIS L. 1971
son epouse
1904 LORETTA D. 1977
1926 JULIEN A. 1976

(R9#183) JULIEN A HUARD
PFC US Army
World War II
1926 1976

(R9#184) EARL
1914 DAVID F. EARL 1999
his wife
1914 MARGUERITE TARDIFF 1997
In loving memory

(R9#185) North Face:

IHS
FOURNIER
Husband Wife
FLORIAN PAULINE
South Face:
PAULINE FLORIAN
1906 - 1986 1898 - 1982

(R9#188)

LACHARITE
AIME J. GRACE M.
1902 - 1990 1907 - 1995
In loving memory

(R9#189)

CHAMBERLAND
JOSEPH D. YVONNE G.
1900 - 1971 1901 - 1982

(R9#191) North Face:

VINEY
PAUL SUSAN
South Face:
PAUL VINEY Jr.
July 11, 1905 - Sept. 18, 1984
his wife
SUSAN DOROTHY
Apr. 26, 1997

(R9#194)

DAIGLE
CARON
1912 ANNE MARIE DAIGLE 1995
1921 JEANNE D'ARC CARON 2005

(R9#196) North Face:

LAMARRE
South Face:
1919 ROGER 1971
1900 ALICE C. 1976
1895 EDWARD E. 1980

(R9#186) South Face:

DROLET
North Face:
1896 ROSE A. DROLET 1971
1921 EVANS J. son 2007
1926 YVONNE C. wife

(R9#187)

EVANS E DROLET
Tec 4 US Army Air Force
World War II
Mar 27 1921 Oct 5 2007

(R9#190)

MAURICE R.
CHAMBERLAND
1934 - 1975

(R9#192)

LAVOIE
ALPHONSE J. THELMA R.
1925 - 1971 1924 -

(R9#193)

AMANDA GRACE
LAVOIE
Sept. 13, 1991
dau. of ANNE and STEVE

(R9#195)

BERNIER
ARMAND R. PAULINE
1926 - 1987 1932 -
1903 JOSEPH R. 1971

(R9#197)

ALICE C. LAMARRE
Oct. 22, 1900
Mar. 11, 1976

(R9#198) PELLETIER
1924 JAMES 1971 1923 THERESE

(R9#199) PAIEMENT
EDDIE YVONNE
1895 - 1971 1900 - 1991

(R9#200) BOUSQUET
WILFRID H. DOROTHY M.
1914 - 1971 1920 -

(R9#201) JOSEPH W H BOUSQUE
Maine
T Ord Co 633 Repl D
World War II
Oct 21 1914 May 20 1971

(R9#202) FLUET
IRENEE FLORENCE
1903 - 1990 1914 -

(R9#203) MAROIS
Married
1912
WILFRED ROSE
1889 - 1971 1890 - 1973

(R9#204) IHS
ALLARD
1905 EDMOND 1971
1916 IDA 1996

(R9#206) LABONTE
1909 ROSARIO M. 1971
his wife
1916 CEDEA M. 2005

(R9#205) North Face:

CARON

South Face:

LOUIS J. L. FREDERICK
1908 - 1989 1936 - 1970
GENEVA A. PAULINE C.
1917 - 1985 1938 -

(R9#207) CLOUTIER
1912 THEOPHILE 1971
wife
1910 EMMA 1985

(R9#208) OSCAR CLOUTIER
1911 - 1971

(R9#210) North Face:

WHITE

South Face:

(R9#209) YVONNE CLOUTIER
1916 - 1997

SHIRLEY F. WHITE
Jan. 25, 1912 - Dec. 23, 1971
his wife
RUTH S. WHITE
Mar. 18, 1920 - Aug. 2, 2001

(R9#211) GOSSELIN
ROSE L. RAOUL F.
1894 - 1971 1896 - 1980

Marker: U.S. Veteran

(R9#212) **RAOUL F GOSSELIN**
US Navy
World War II
1896 - 1980

(R9#213) **BOUCHARD**
ALICE RITA D.
1884 - 1971 1922 - 199

(R9#214) **BOUCHARD**
In ARMAND D. FLORA L.
God's Mar. 18, 1911 Aug. 13, 1909
care June 22, 2000 Nov. 18, 1994

(R9#215) Hail Mary
SIMPSON
1910 JOSEPH 1977
wife
1908 MAUDE 2000

(R9#216) **BISSON**
LEO G. HELEN M. MARIE J. Marker: U.S. Veteran
1930 - 1971 Infant 1962 1928 - 1999

(R9#217) Our little angel
REBECCA KIM BISSON
August 1, 1983

(R9#218) **LEO G BISSON**
Maine
Cpl US Marine Corps
Korea
Feb 16 1930 March 30 19

(R9#219) **LACASSE**
GEORGE D. THERESA his wife
1914 - 1998 1924 - 2005

(R9#220) **COULOMBE**
1901 FENELON 1971 1900 YVONNE 19

(R9#221) **GIROUX**
EDNA C. LUCIEN W.
1910 - 1970 1912 - 2003
In loving memory

(R9#223) **WALTER E JOHNSON**
Maine
Mech US Army
World War I
Oct 13 1894 Jan 22 1974

(R9#222) North Face:
JOHNSON
In God's care

South Face:
JOHNSON
WALTER E. JOHNSON
Oct. 13, 1894 - Jan. 22, 1974
his wife
GLADYS H. MAGEE
Apr. 21, 1918 - Nov. 12, 1970

Marker: U.S. Veter

(R9#224)

BERNIER
ROMEO F. FLORENCE G.
1912 - 1988 1917 -
Married Aug. 1, 1936

(R9#225)

BERNIER
JOSEPH "VAL" BERNI
1919 - 1970
his wife
ROSE A. MICHAUD
1922 -
In loving memory

(R9#226)

LABBE
RAOUL RYNELL ERLAND
1917 - 1995 1924 - 1949 - 1970
In loving memory

ST. JOHN THE BAPTIST CEMETERY - Range Layout

RANGE #10

Map #1

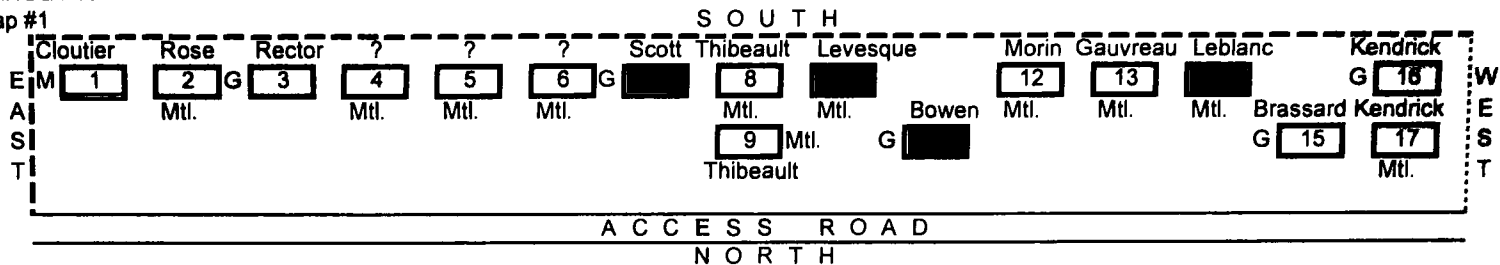

RANGE #10

Map #2

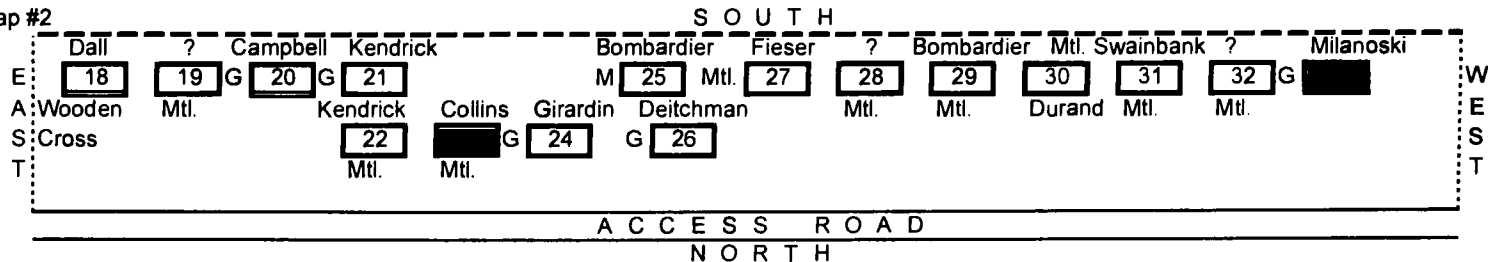

RANGE #10

Map #3

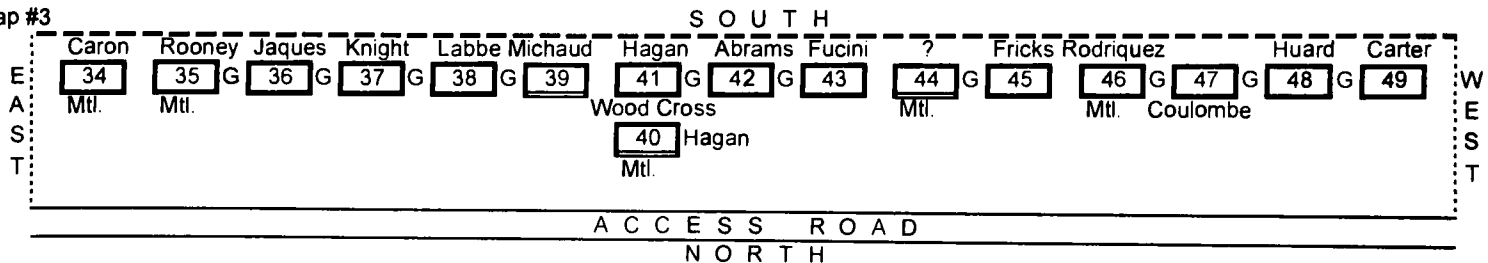

ST. JOHN THE BAPTIST CEMETERY - Range Layout

RANGE #10

Map #4

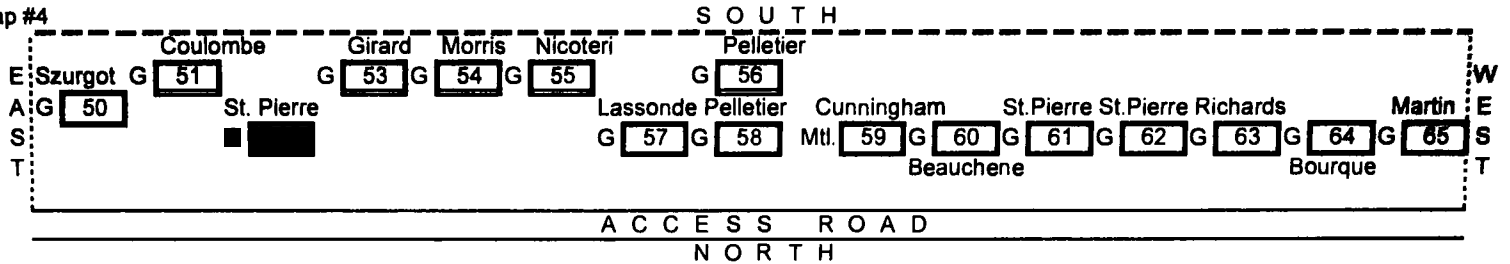

RANGE #10

Map #5

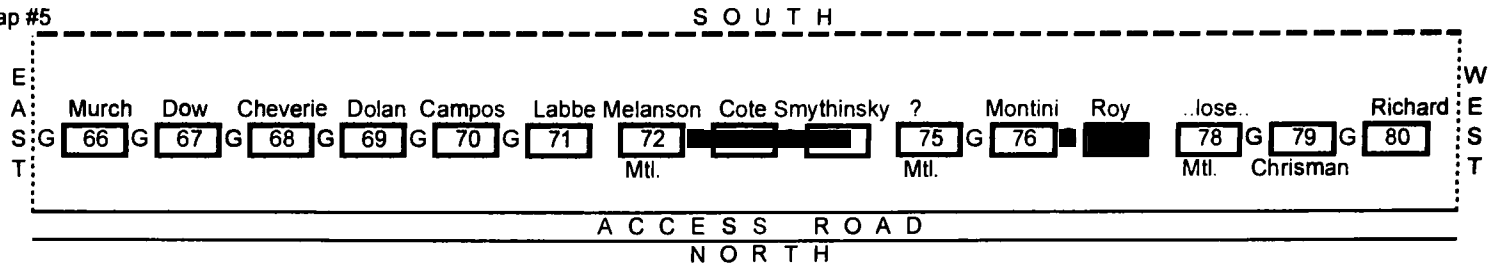

RANGE #10

Map #6

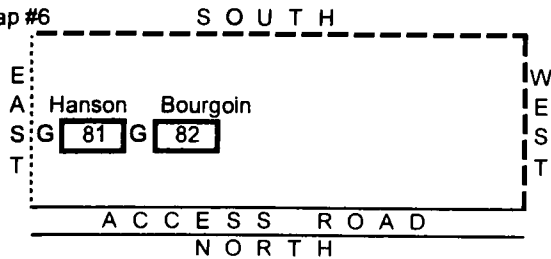

RANGE #10

- (R10#1) **LAURIER J.
CLOUTIER Jr.
Feb. 14, 1950
July 31, 1950**
- (R10#2) **RICHARD M. ROSE
1951 - 1951**
- (R10#3) **DENNIS PAUL RECTOR
June 10, 1951
Dec. 28, 1951**
- (R10#4) (Remains of metal marker,
no name or dates)
- (R10#5) (Remains of metal marker,
no name or dates)
- (R10#6) (Remains of metal marker,
no name or dates)
- (R10#7) **ROBERT P. SCOTT
Dec. 1, 1957
Apr. 18, 1958**
- (R10#8) **JOSEPH P. THIBEAULT
June 14, 1965
June 26, 2005**
- (R10#9) **ERNEST THIBEAULT
1958 - 1958**
- (R10#10) **MARIE A. LEVESQUE
1958 - 1958**
- (R10#11) **Infant
JAMES D. BOWEN
1958 - 1958**
- (R10#12) **Our little angel
PATRICK R. MORIN
4 - 2 - 1958
10 - 15 - 1958**
- (R10#13) **REBECCA M GAUVREAU
June - 1959**
- (R10#14) **ALAIN LEBLANC
1959 - 1959**
- (R10#15) **Our beloved sons
PETER and PAUL
BRASSARD
July 1959**
- (R10#16) **ANTHONY J.
KENDRICK III
Sept. 10, 1960
Sept. 17, 1960**
- (R10#17) **ANTHONY KENDRICK III
1960 1960**
- (R10#18) **RONALD DALL
born Oct. 30, 1960
died Oct. 30, 1960**

(R10#19) (Remains of metal marker,
no name or dates)

(R10#20) ALAN WAYNE
CAMPBELL
Aug. 24, 1959
Apr. 25, 1961

(R10#21) KENDRICK
Twin Daughters
May 15, 1961
May 16, 1961

(R10#23) JOHN COLLINS
1961 1961

(R10#22) KENDRICK TWINS
1961 1961

(R10#24) GIRARDIN
Feb. 15, 1962

(R10#25) ALLEN D. BOMBARDIER
Oct. 1963

(R10#26) THOMAS ERIC
DEITCHMAN
Sept. 8, 1963
Nov. 16, 1963

(R10#27) MARLENE LYNN FIESER
1964 - 1964

(R10#28) (Remains of metal marker,
no name or dates)

(R10#29) ALLEN D. BOMBARDIER
Sept. 1966

(R10#31) BETH ANNE SWAINBANK
1968 - 1968

(R10#30) MELISSA M. DURAND
1966 - 1966

(R10#32) (Remains of metal marker,
no name or dates)

(R10#33) MONIQUE A.
MILANOSKI
November
19 1969
Five weeks
of love

(R10#34) JUDY CARON
1970 - 1970

(R10#36) STEPHEN L. JAQUES
June 19, 1971
August 10, 1971

(R10#35) Baby Boy ROONEY
1970 - 1970

(R10#37) Our precious baby
JAMES TYLER KNIGHT
Oct. 15, 1976 - Oct. 19, 1976

(R10#38) Our angel
Baby Boy
LABBE
May 8, 1974

(R10#39) Beloved daughter
of
ROBERT & ROBIN
ELAINE CORRINE
MICHAUD
December 19, 1978

(R10#40) LISA MARIE HAGAN
1979 - 1980

(R10#42) BROOKE C. ABRAMS
June 2, 1980

(R10#41) L
I
S
A
Sept. 21, 1979 April 9, 1980

(R10#43) KATHLEEN L. FUCINI
Mar. 17, Oct. 10,
1982 1982

M
A
R
I
E

(R10#44) (Remains of metal marker,
no name or dates)

(R10#45) Our little baby
MICHAEL A. FRICKS Jr.
June 20 - 25, 1983

(R10#46) RICHARD LEE RODRIQUEZ
1984 - 1984

(R10#47) WILLIAM A. COULOMBE
February 14, 1929
November 22, 1986

(R10#48) GEORGE HUARD
1915 - 1980

(R10#49) ALMA CARTER
Dec. 10, May 19,
1904 1979
Forever loved

(R10#50) HELEN H. SZURGOT
Apr. 24, 1916
Nov. 15, 1974

(R10#51) LUCIENNE
COULOMBE
1904 - 1984

(R10#52) EDWARD R ST. PIERRE
Maine
PFC US Army
World War II
Feb. 19, 1917 July 31, 1973

Marker: U.S. Veteran

(R10#55) NICOTERI
GIOCINTO
October 19, 1887
January 1, 1980

(R10#57) JOSEPH T. LASSONDE
1896 - 1971

(R10#58) ERNEST PELLETIER
Maine
Co. K. 36 Infantry
World War I
Sept. 21, 1891 July 6, 1970

(R10#61) WILLIAM ST. PIERRE
Dec. 11, 1908
Jan. 22, 1969

(R10#62) ANNIE ST. PIERRE
Apr. 14, 1904
Feb. 15, 1968

(R10#64) ALFREDA BOURQUE
1889 - 1966
epouse de
ALFRED BOURQUE

(R10#53) GIRARD
WILFRID H.
Mar. 15, 1915
Jan. 23, 1973

(R10#54) Our beloved child
SANDRA LYNN MORRIS
Dec. 8, 1966 - Oct. 4, 1972

(R10#56) PELLETIER
ERNEST
Sept. 21, 1891 July 6, 1970

Marker: U.S. Veteran

(R10#59) ROSE M. CUNNINGHAM
1894 - 1970

(R10#60) OMER A BEAUCHENE
Maine
Tec 5 Corps of Mil Police
World War II
Dec 8 1917 March 2 1969

(R10#63) HENRY J RICHARDS
Massachusetts
Sgt 2 Signal Bn
World War II
May 3 1908 Dec 29 1967

(R10#65) JOSEPH S. MARTIN
Mar. 20, 1895
Jan. 7, 1969

(R10#66) MARY A. MURCH
1883 - 1965

(R10#67) Our dear son
JAMES D. DOW
1962 - 1965
son of LEONARD
and MARIE DOW

(R10#68) KARLA L. CHEVERIE
March 7, 1950 - Aug. 11, 1964
Dedicated by
relatives and friends

(R10#69) RICHARD J DOLAN
1950 - 1963

(R10#70) In memory of
PAUL CAVANAUGH CAMPOS
Nov. 24, 1959 May 22, 1963
son of
Mr. and Mrs. ANTONIO CAMPOS
Dedicated by
VP 10 Enlisted Men

(R10#71) JOHN J LABBE
Maine
Pvt US Army
World War I
May 30 1889 March 21 1963

(R10#72) LEO J. MELANSON
1902 - 1962

(R10#73) MAURICE A. COTE
1881 - 1961

(R10#74) JOSEPH SMYTHINSKY
Maine
Pvt Co C 151 Depot Brigade
World War I
June 7 1890 July 28 1961

(R10#75) (Remains of metal marker.
no names or date.)

(R10#76) ROBERT MONTINI
Dec. 18, 1893 - July 3, 1960
Erected by
Mr. & Mrs. ROLAND CLOUTIER

(R10#77) JOSEPH ROY
1864 - 1960

(R10#79) ALBERT J.
CHRISMAN, Sr.
Aug. 6, 1902
Sept. 14, 1959

(R10#78) PHILIP ...LOSE...
1881 - 1960

(R10#80)

PHILIP RICHARD
Maine
Pvt 7 Co Coast Arty
World War I
June 13 1897 March 7 1959

(R10#81)

CECILIA I. HANSON
1905 - 1957

(R10#82)

Father
ALCIDE BOURGOIN
1905 - 1956

FOCUS
STRIP

ST. JOHN THE BAPTIST CEMETERY - Range Layout

RANGE #11
Map #1

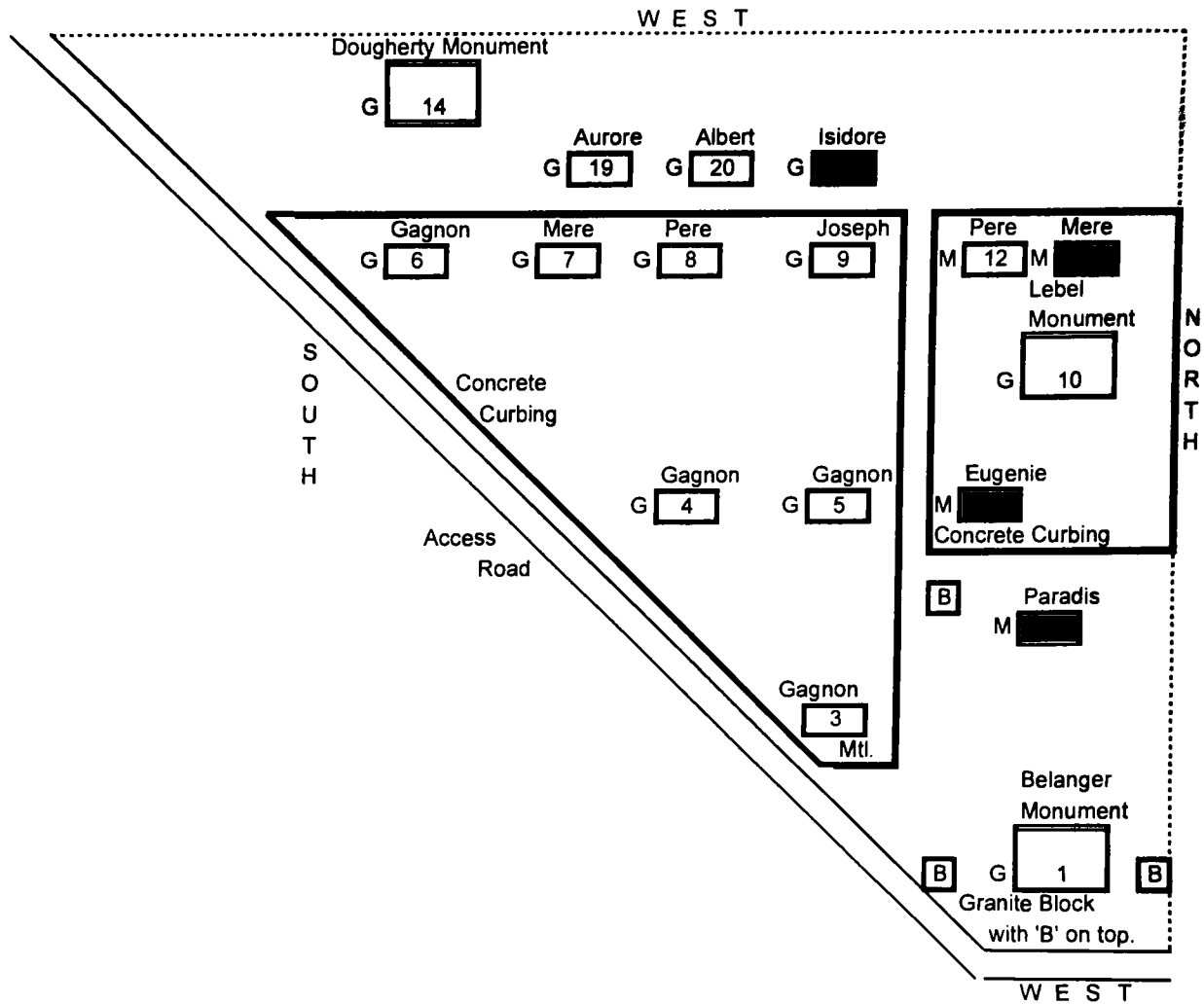

ST. JOHN THE BAPTIST CEMETERY - Range Layout

RANGE #11

Map #2

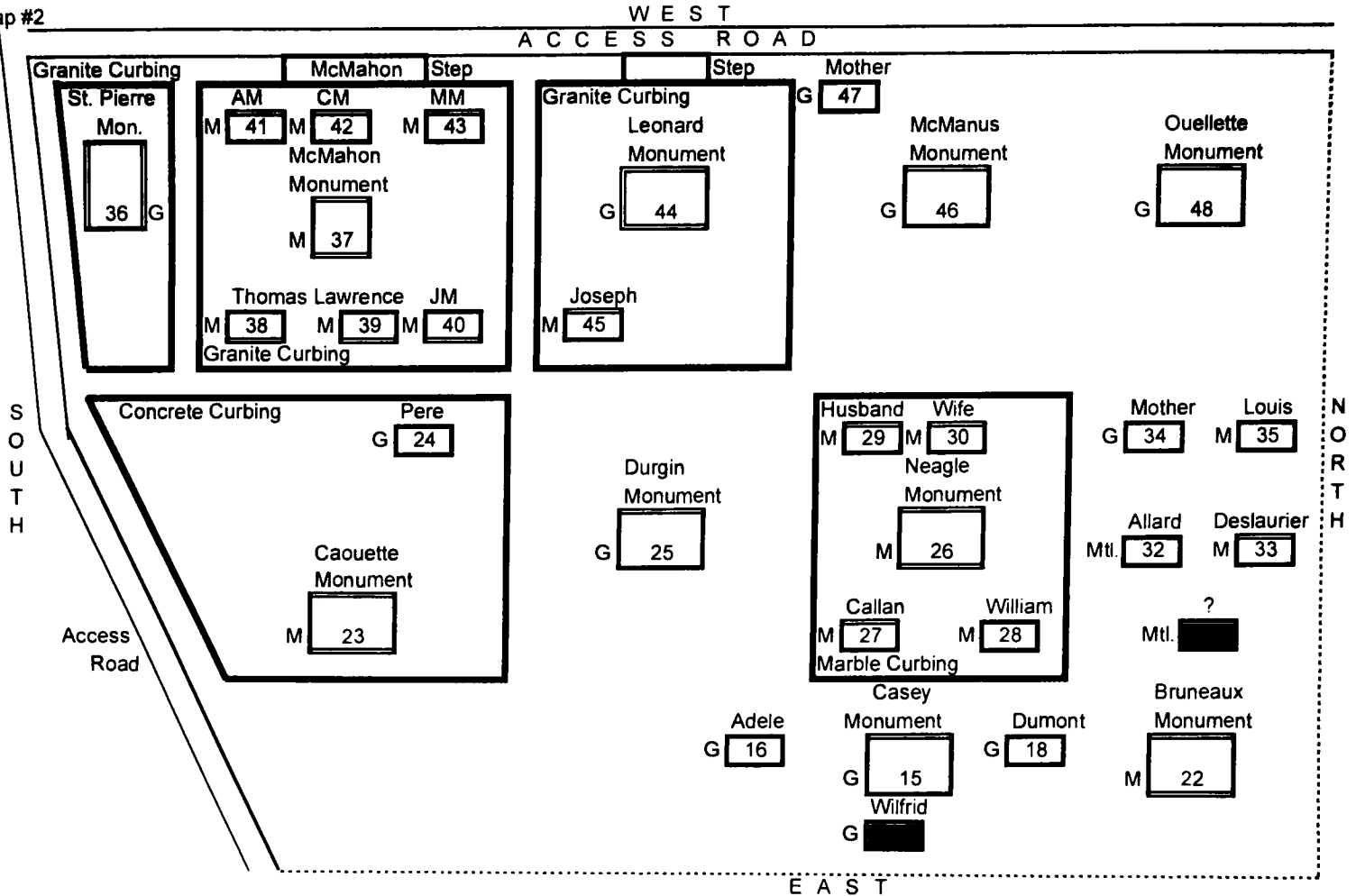

ST. JOHN THE BAPTIST CEMETERY - Range Layout

RANGE #11
Map #3

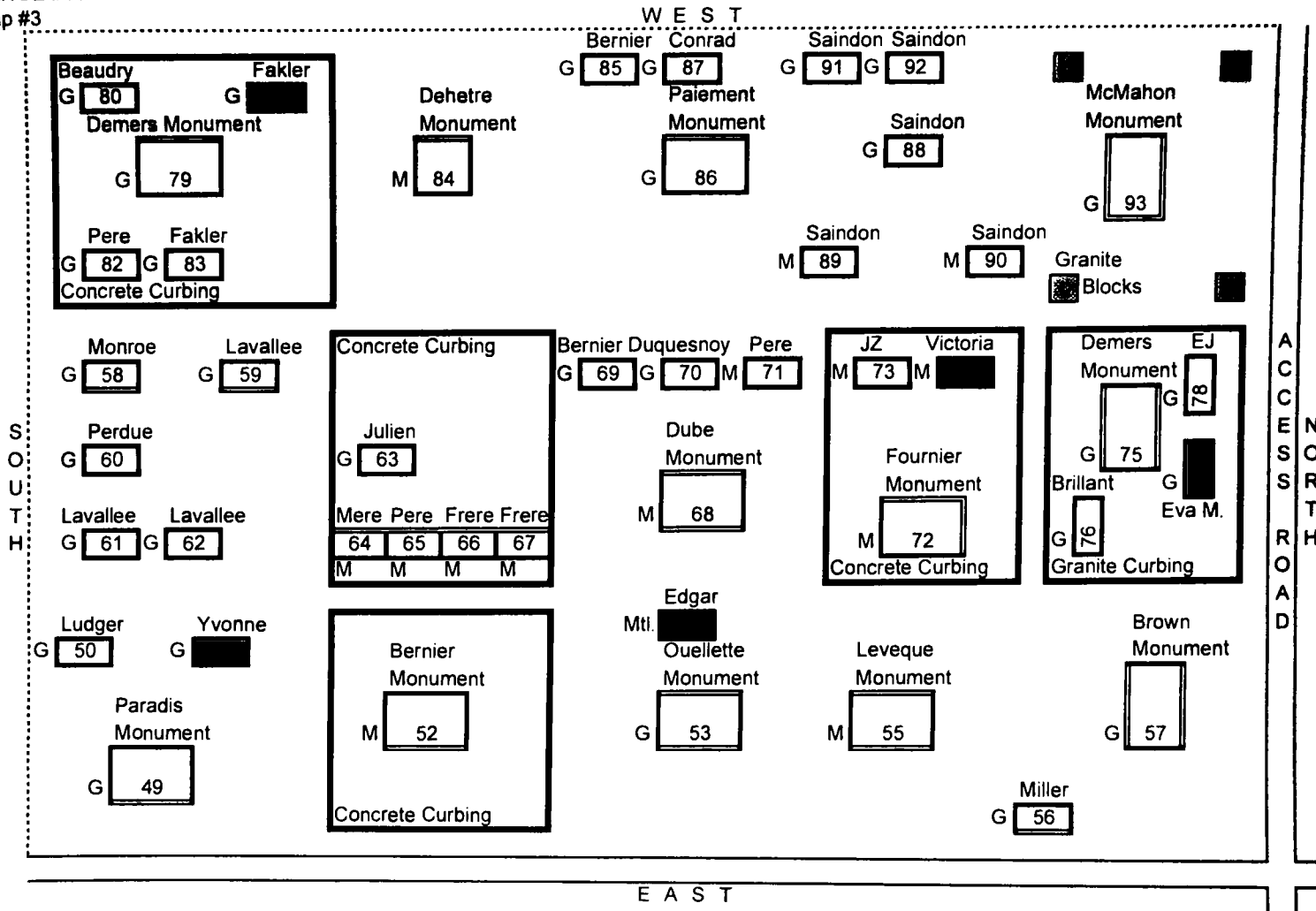

ST. JOHN THE BAPTIST CEMETERY - Range Layout

RANGE #11
Map #4

WEST
ACCESS ROAD

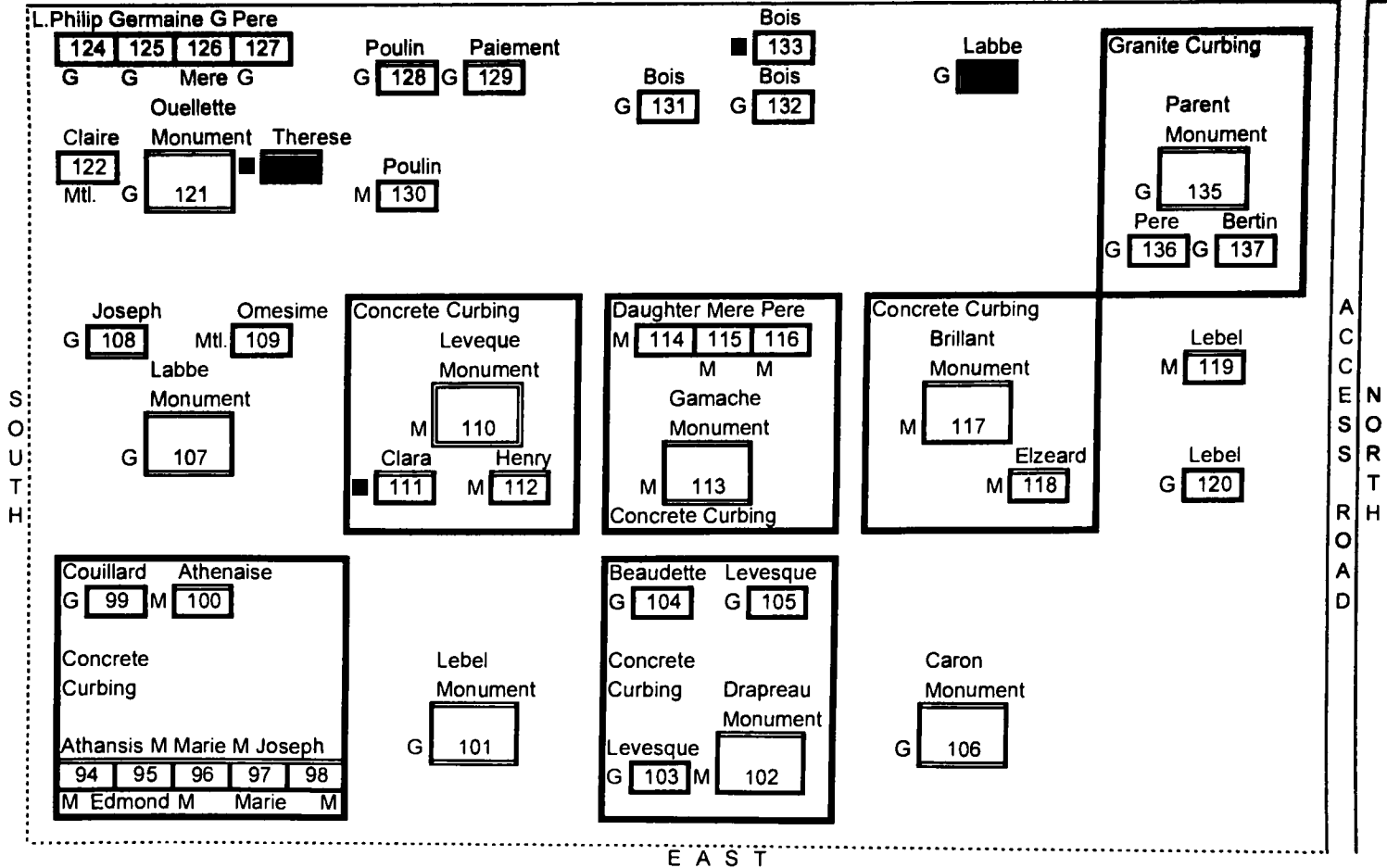

EAST

ACCESS ROAD

RANGE #11

(R11#1) Belanger Monument

1879 FABIEN J. BELANGER 1952
 1886 ROSANNA L. BELANGER 1967
 1906 LILLIAN M. BELANGER 1971

(R11#2) Top of stone:

WIFE

Face of stone:

Ici repose
 JULIA PARADIS
 epouse de
 JOSEPH LEVESQUE
 decede le 3 June 1896
 a l'age de 22 ans.

(R11#3) PLACIDE GAGNON, Jr.

May 23 June 8
 1938

(R11#4) ROSEANNA
 1879 - 1965

(R11#5) ALPHONSE GAGNON
 1871 1959

(R11#6) LOUISE GAGNON
 1877 1949

(R11#7) MERE

(R11#8)

PERE

(R11#9)

JOSEPH

(R11#10) Lebel Monument

OCTAVE LEBEL
 1827 - 1915
 EMERANCE son epouse
 1833 - 1918
 EUGENIE
 LEBEL

Marker Stones:

(R11#11) EUGENIE

(R11#12) PERE

(R11#13) MERE

(R11#14) Dougherty Monument

West Face:

JOHN DOUGHERTY
 May 10, 1851 - Apr. 15, 1896
 May his soul rest in peace
 KATHERINE his wife
 Jan. 7, 1852 - Dec. 11, 1909
 May her soul rest in peace
 DOUGHERTY

East Face:

JOHN A. DOUGHERTY
 1881 - 1946
 MARY C. DOUGHERTY
 Apr. 9, 1878 - Dec. 19, 1928

(R11#15) Casey Monument

CASEY

Marker: U.S. Veteran

Marker Stones:

(R11#16) ADELE MARTEL CASEY
 1865 - 1905

(R11#17) WILFRID CASEY
 died 1905
 age 5 wks

Marker Stones Cont'd.:

(R11#18) EORGINA DUMONT
wife of
CHARLES ST. PIERRE
1861 - 1898

(R11#19) AURORE CASEY
1874 - 1968

(R11#20) ALBERT L. CASEY
1899 - 1946

(R11#21) ISIDORE CASEY
1868 - 1947

(R11#22) Bruneaux Monument

East Face:

MOTHER FATHER

West Face:

IHS

FRANCOIS BRUNEAUX

1822 - 1894

JULIA DAIGLE, his wife

1830 - 1902

BRUNEAUX

(R11#23) Caouette Monument

West Face:

In memoire

ALPHONSE CAOUELETTE

nee 6 Decembre 1872

decede le 19 Mai 1929

East Face:

IRMA CAOUELETTE LUDGER CAOUELETTE

decede

decede

a l'age de 5 ans et

a l'age de 6 mois

un mois

enfants de

LYDIA et ALPHONSE CAOUELETTE

(R11#25) Durgin Monument

D

MICHAEL DURGIN

Oct. 27, 1884

1867 JOSEPH H. DURGIN 1955

MICHAEL MADDEN

Sept. 4, 1865

Mar. 4, 1939

DURGIN

Marker Stone:

(R11#24) PERE

(R11#26) Neagle Monument

West Face:

JOHN D. NEAGLE

June 1, 1859

Mar. 23, 1895

MARY F., wife of

W. I. DECOSTE

1860 - 1910

NEAGLE

East Face:

WM. I. DECOSTE

1867 - 1932

Marker Stones:

(R11#27) Top of stone:

BROTHER

Face of stone:

M. J. CALLAN

died

Sept. 22, 1888,

Ae. 21 yrs.

Marker Stones Cont'd.:

(R11#28) WILLIAM (R11#29) HUSBAND (R11#30) WIFE

(R11#31) (Remains of metal marker,
no names or date.)

(R11#32) ALLARD, FLORA
March 15, 1966
March 1966

(R11#33) ELIZABETHE DESLAURIER
epouse de
CYPRIEN COTE
decedee le 31, Oct. 1897
a l'age de 28 ans et 8 mois.
Priez pour elle.

(R11#34) MOTHER
1884 - 1966

(R11#35) LOUIS COTE
1891 - 1905

(R11#36) St. Pierre Monument

South Face:

ST. PIERRE

North Face:

FRANCOIS ST. PIERRE

1869 - 1938

son epouse

AMANDA LABEL

1867 - 1945

enfants

ANNETTE ADRIENNE

(R11#37) McMahon Monument

West Face:

LAURENCE McMAHON

died

Nov. 11, 1876

May his soul rest in peace

McMAHON

East Face:

THOMAS

son of

LAURENCE & CATHERINE

McMAHON

born Sept. 24, 1870

died May 24, 1871

Ae. 8 mos.

Marker Stones:

(R11#38) THOMAS

(R11#39) LAWRENCE McMAHON

30th

Me.

Inf.

Marker: U.S. Veteran

Marker Stones Cont'd.:

(R11#40) J. M. (R11#41) A. M. (R11#42) C. M.
(R11#43) M. M.

(R11#44) Leonard Monument

West Face:

MICHAEL LEONARD
1826 - 1896
CATHERINE his wife
1821 - 1897
MARY E. their dau.
1858 - 1883
LEONARD

East Face:

MARTIN LEONARD
1854 - 1913
JOHANNAH his wife
1857 - 1940
JOSEPH D. their son
1891 - 1921

South Face:

MINNIE C.
LEONARD
1877 - 1893

Marker Stone:

(R11#45)

JOSEPH D.
LEONARD
Maine
Yeoman 1 CI USNRF
May 2, 1921

Marker: U.S. Veteran

(R11#46) McManus Monument

KATHERINE McMANUS
1836 - 1906

Marker Stone:

(R11#47)

MOTHER

(R11#48) Ouellette Monument

OUELLETTE
EDWARD A. OUELLETTE
BLANCHE A. his wife

(R11#49) Paradis Monument

Husband
LUDGER A. PARADIS
Sept. 14, 1896 - Nov. 14, 1956
Wife
YVONNE E. DUBE
Dec. 21, 1900 - July 10, 1972
Say a Hail Mary

Marker: U.S. Veteran

Marker Stone:

(R11#50)

LUDGER A PARADIS
Maine
Pvt 2 Co Coast Arty
World War I
Sept 14 1896 Nov 14 1956

(R11#51)

**YVONNE PARADIS
FORTIN**

(R11#52) Bernier Monument

CHARLES BERNIER
ne 1870 - 1961
son epouse
MARIE BOURGOIN
ne 1877 - 1930
decede le 13 Sept a lage de 53 ans et 5 mois

(R11#53) Ouellette Monument

East Face:

OUELLETTE
Wife Husband
ALMA PLANTE ADELARD OUELLETTE
April 9, 1899 May 14, 1891
July 28, 1972 May 13, 1980
1871 LEA LABBE O. 1944

West Face:

EDGAR OUELLETTE
June 15, 1921 - Nov. 24, 1993

Marker Stone:

(R11#54)

EDGAR A OUELLETTE
S Sgt US Army
World War II
Jun 15 1921 Nov 24 1993

(R11#56)

Mother
VIVIAN T. MILLER
Apr. 6, 1907
Nov. 25, 1978

(R11#55) Leveque Monument

East Face:

MARIANNE
epouse de
EMILE LEVEQUE
decedee
le 31 Janvier 1892
a l'age de 30 ans 1 mois

West Face:

EMILE LEVEQUE
1861 - 1934

(R11#57) Brown Monument

North Face:

BROWN

South Face:

JOHN P. BROWN
1883 - 1956
CHRISTINE C. his wi
1887 - 1982
J. RICHARD their so
1921 - 1931

(R11#58) **CINDY LEE MONROE**
Apr. 20, 1966 Feb. 5, 1967
daughter of
JAMES and CONSTANCE
LAVALLEE MONROE
Step softly, a dream
lies buried here

(R11#61) **JOSEPH A. LAVALLEE**
1884 - 1947

(R11#63) **EDWARD H JULIEN**
Cpl US Army
World War I
Aug 12 1894 Aug 9 1983

(R11#64) Top of stone:
MERE
Face of stone:
EMMA
epouse de
A. FOURNIER
1853 - 1917

(R11#68) **Dube Monument**
East Face:
Ici reposant les
membres defunts
de la famille
de
JEAN MARIE DUBE
West Face:
ABEL DUBE
1868 - 1942
EMMA, wife
1868 - 1951
THODULE DUBE
1891 - 1956
VIRGINIA, wife
1891 - 1927

(R11#59) **LAVALLEE**
JULIETTE R. FRANCIS J
1913 - 1985 1908 - 1981

(R11#60) **CINDY PERDUE**
Sept. 22, 1957
Dec. 12, 1957

(R11#62) **ADA LAVALLEE**
his wife
1886 - 1960

(R11#65) Top of stone:
PERE
Face of stone:
ABRAHAM
FOURNIER
1849 - 1925

(R11#66) Top of stone:
FRERE
Face of stone:
HARMIDAS FOURNIER
1879 - 1945

(R11#67) Top of stone:
FRERE
Face of stone:
NULES J. FOURNIER
epouse de
ROSE LAVALLEE
1874 - 1922

Marker: U.S. Veteran

Marker Stones:

(R11#69)

FRANK BERNIER
Maine
Chief Mech 54 Arty Cac
World War I
May 17 1893 Feb 8 1950

(R11#70)

GENEVIEVE G. DUQUESNOY
Aug. 31, 1898 Dec. 22, 1961
wife of
FRANK BERNIER

(R11#71)

Pere
ABEL DUBE
1868 - 1942

(R11#72) Fournier Monument

West Face:

JOSEPHINE,
wife of
J. Z. FOURNIER
born Jan. 24, 1863
died Apr. 6, 1892
FOURNIER

North Face:

J. PIERRE
born Aug. 17,
died Nov. 2, 1885
J. Z. SILVIO
born Feb. 18,
died July 16, 1891
J. TELESPHORE
born Feb. 4,
died July 16, 1892

Marker Stones:

(R11#73)

J. Z. FOURNIER
1855 - 1937

(R11#74)

VICTORIA
FOURNIER
1871 - 1954

(R11#75) Demers Monument

North Face:

E. J. DEMERS

South Face:

ELVERY J. DEMERS
2 Avril 1887 - 18 Juil. 1956
son epouse
EVA M. MUTTY
19 Dec. 1885 - 29 Avr. 1959

Marker Stones:

(R11#76)

BRILLANT
RUSSELL LEAH
1916 - 1978 1915 - 1976
"Love"

(R11#77)

EVA M.
Vierge Marie priez pour nous.

(R11#78)

ELVERY J.
Jesus misericorde

(R11#79) Demers Monument

Famille
de
F. X. DEMERS

Marker Stones:

(R11#80) CECILE B. BEAUDRY
1866 - 1962

(R11#81) OXZA R. FAKLER
1885 - 1961

(R11#82) 1863 PERE 1928

(R11#83) JOHN T. FAKLER
1876 - 1949

(R11#86) Paiement Monument

PAIEMENT
CONRAD W. GERMAINE O.
1921 - 2000 1924 - 1997
In God's care

(R11#84) Dehetre Monument
La
famille
J. B. DEHETRE

Marker: U.S. Veteran

Marker Stone:

(R11#87) CONRAD W PAIEMENT
TEC 5 US Army
World War II
Jul 24 1921 Jul 2 2000

(R11#85) ROBERT P BERNIER
son of
FRANK and GENEVIEVE
June 28, 1937 Apr. 30, 1995

(R11#88)

SAINDON
GEORGE A. CEDEA M.
July 3, 1891 Oct. 15, 1890
Apr. 8, 1980 Jan. 28, 1961

(R11#89) GEORGE A.
SAINDON
1891 - 1980

(R11#91)

RODOLPHE C SAINDON
Cox US Navy
World War II
Feb 4 1926 Jun 12 1999

(R11#90) CEDEA
SAINDON
1890 - 1961

(R11#92)

LOUISE J SAINDON
wife of RODOLPHE G SAINDON
Aug 30 1927 -

(R11#93) McMahon Monument

North Face:

THOMAS F. McMAHON
Nov. 5, 1853 May 29, 1905
his wife
ELIZABETH BONNAR
Mar. 17, 1853 Aug. 20, 1940
McMAHON

South Face:

WILLIAM B. McMAHON
1888 - 1958
MARY E. McMAHON
1878 - 1970
KATHERINE McMAHON
1891 - 1966

East Face:

JOSEPH W.
July 2, 1882
Mar. 20, 1886
ELLEN M.
Mar. 9, 1890
July 1, 1914

(R11#94)

ATHANSIS
1878 - 1883

(R11#95)

EDMOND
1884 - 1884

(R11#96)

MARIE
JOSEPHINE
1883 - 1885

(R11#97)

MARIE ANNA
1885 - 1890

(R11#98)

JOSEPH
1887 - 1890

(R11#99)

DAVID COUILLARD
1888 - 1967

(R11#100)

Ici repose de
MARIE ATHENAISE
epouse de
JAMES COUILLARD
1855 - 1922
R. I. P.

(R11#101) Lebel Monument

West Face:

LEBEL

Jesus, Marie et Joseph

East Face:

EMILE H. LEBEL

4 Nov. 1891 - 3 Mars 1955

ses epouses

NELIDA DIONNE

14 Juil. 1885 - 12 Mai 1953

ALMA POITRAS

(R11#102) Drapreau Monument

Ici
repose le corps de
JOSEPH T. DRAPREAU
decede le 15th de Janvier
1885 a l'age de 27 ans.
epoux de **LINA TREMBLAY**
Priez pour lui.

Marker Stones:

(R11#103)

ALDORIEN LEVESQUE
1912 - 1977

(R11#104)

LENA BEAUDETTE
1866 - 1938

Marker Stones Cont'd.:
(R11#105)

LEVESQUE
FLORENDY Married THOMAS
1880 - 1963 June 23, 1902 1880 - 1963
Jesus Marie Joseph

(R11#106) Caron Monument

East Face:

URBAIN D. CARON
1906 - 1975
his wife
ANNA WAS
1914 - 1997
their dau.
DEANNA J.
1937 -

West Face:

en repos
URBAIN D. CARON
1829 - 1893
son epouse
JULIENNE THEBERGE
1830 - 1892

(R11#107) Labbe Monument

West Face:

LABBE

East Face:

EDWARD J. LABBE
Aug. 8, 1872 Jan. 14, 1949
BERNADETTE M. his wife
Oct. 15, 1891 May 25, 1983

Marker Stones:

(R11#108)

Ici
repose le corps de
JOSEPH O.
enfant de
JOSEPH O. LABBE
MARIE RAYMOND
decedee
le 6 Decembre 1891
a l'age de 5 ans et 5 mois

(R11#110) Leveque Monument

West Face:

LEVEQUE
ISRAEL LEVEQUE
1848 - 1929
HERMINE son epouse
1849 - 1935
CLARA LEVEQUE
Nov. 11, 1874 - Juillet 7, 1904

South Face:

DOLORES
1884 - 1939
HELENA
1878 - 1955
EVA
1879 - 1951

(R11#109)

ONESIME LABBEE
1849 - 1921

East Face:

1876	DOLOR	1877
1880	FLORINDE	1882
1881	WILLIE	1881
1884	OLEVINE	1885
1886	EDGAR	1886
1890	FLOLIEN	1890

enfants de ISRAEL et HERMINE LEVEQUE

(R11#110) (Leveque Monument Cont'd.)

North Face:

HENRI J.
LEVEQUE
Juin 3, 1888
Juillet 14, 1917

Marker Stones:

(R11#111) CLARA

(R11#112) HENRI

(R11#113) Gamache Monument

West Face:

GAMACHE

East Face:

EUSTACHE PIERRE GAMACHE
1890 - 1943
LAURA ZELIA CARON son epouse
1898 - 1933
CONSTANCE G. PALMER dau.
1918 - 1993
GERMAIN E. GAMACHE son
1922 - 2008

Marker Stones:

(R11#114) DAUGHTER

(R11#115) MERE

(R11#116) PERE

(R11#117) Brillant Monument

ZEPHIRIN BRILLANT
1829 - 1906
EMILIE, son epouse
1840 - 1921
BRILLANT

Marker Stone:

(R11#118) ELZEARD BRILLANT
decede
le 10 Juillet 1882
a l'age de 6 ans 8 mois

(R11#119)

Priez pour l'ame
de
DEMETRIUS LEBEL,
decede
le 23 Fevrier 1885,
a l'age de
28 ans 5 mois

(R11#120)

JOSEPHINE LEBEL
1896 - 1981

(R11#121) Ouellette Monument

West Face:

OUELLETTE

notre pere : que votre

qui etes : nom

aux : soit

cioux : sanctifie

epoux

CYPRIEN

1882 - 1958

epouse

MARIE - ANNE

1885 - 1967

East Face:

LOUIS PLOURDE

1840 - 1920

son epouse

CLARA ST. PIERRE

1854 - 1913

Marker Stones:

(R11#122)

CLAIRE

DEHETRE

1908 - 1985

(R11#123)

THERESE

1943 - 1951

(R11#124)

L. PHILIP

1910 -

(R11#125)

GERMAINE

1917 - 2000

(R11#126)

MERE

(R11#127)

PERE

(R11#128)

POULIN

1893 ALPHA 1939

his wife

1889 MALVINA 1938

In loving memory

(R11#129)

PAIEMENT

FLORIEN PAIEMENT

1896 - 1963

son epouse

CLARA POULIN

1902 - 1973

Dites un je vous salue Marie

(R11#130)

ADELE POULIN

1864 - 1952

(R11#131)

Wife

RENA R. BOIS

Jan. 5, 1926 - May 15, 1957

"Say a Hail Mary"

(R11#132)

Husband

BERTRAND A. BOIS

May 10, 1924 - Feb. 2, 2000

"Say a Hail Mary"

(R11#133)

BERTRAND A BOIS

MML3 US Navy

World War II Korea

May 10 1924 Feb 2 2000

(R11#134)

LABBE

DORA L. LEONCE

1902 - 1988 1892 - 1978

(R11#135) Parent Monument

West Face:

MAJORIQUE PARENT

1848 - 1935

son epouse

CLAUDIA LEBEL

1867 - 1933

PARENT

Marker Stones:

(R11#136) PERE

East Face:

Enfants

1894 JOSEPH EDGAR 1894

1894 JOSEPH ELIOT 1894

1891 MARIE ALBERTINE 1903

(RR11#137) BERTIN

ST. JOHN THE BAPTIST CEMETERY - Range Layout

RANGE #12

Map #1

WEST

ACCESS ROAD

NORTH

ACCESS ROAD

EAST

Caron Monument
M 28

Normand Monument
M 29
Mari M 30
Mother/Father M 31
Granite Curbing

Geoffrey G 33 Laura G
Concrete Curbing
Normand Monument G 32

Paradis Monument M 35
St.Pierre M 36

Concrete Curbing
St. Onge Monument G 13

Granite Curbing Yvonne G 18
Brilliant Monument G 14
M.Alma M L.Adolph M 15 16 17
E.George M

Lachance Monument M 19
Eva M 20
Concrete Curbing

Simone M 26 Armand M 27
Caron Monument M 21 Concrete Curbing
Lucien Mere Pere Marie
G M M M

Father G 2

Fortin Monument G 1

Gamache Monument G 4
Concrete Curbing

Lacharite G 6

Caouette Mtl.

Caouette M 10 Boule M 11

Mother G 3
Granite Post F with 'F' on top

Lacharite G 5

Caouette Lavallee Caouette Mtl. 7 8 M 9
Mtl.

ST. JOHN THE BAPTIST CEMETERY - Range Layout

RANGE #12
Map #2

WEST
ACCESS ROAD

ACCESS ROAD
SOUTH

NORTH

Granite Curbing

Morin
Monument

M 51

Granite Curbing
Trudeau Monument

G 52

John J.B. Olivier J.M. J.P. M.L.

53	54	55	56	57	58
M	M	M	M	M	M

Father G 60 G Mother G 61 G Catherine G 62 G Joseph G 63 G Lizzie G 64 G Ted G 65 G Mary G 66

G 59
Dolan
Monument

Granite Curbing

Dufresne
Monument

M 44

Peterson
M 50

J.A. M 45 M Joseph M 46 M George M 47 M Maria M 48 G Nadeau G 49

Roger Conc. Curbing
Beauregard
Monument

41
Mtl.

M 38

Caron
Monument
M 42

Caron
G 37

Cecilia
39
Mtl.

Charles
40
Mtl.

43
Lemieux/Michaud
Monument

Concrete Curbing

EAST

ST. JOHN THE BAPTIST CEMETERY - Range Layout

RANGE #12

Map #3

W E S T

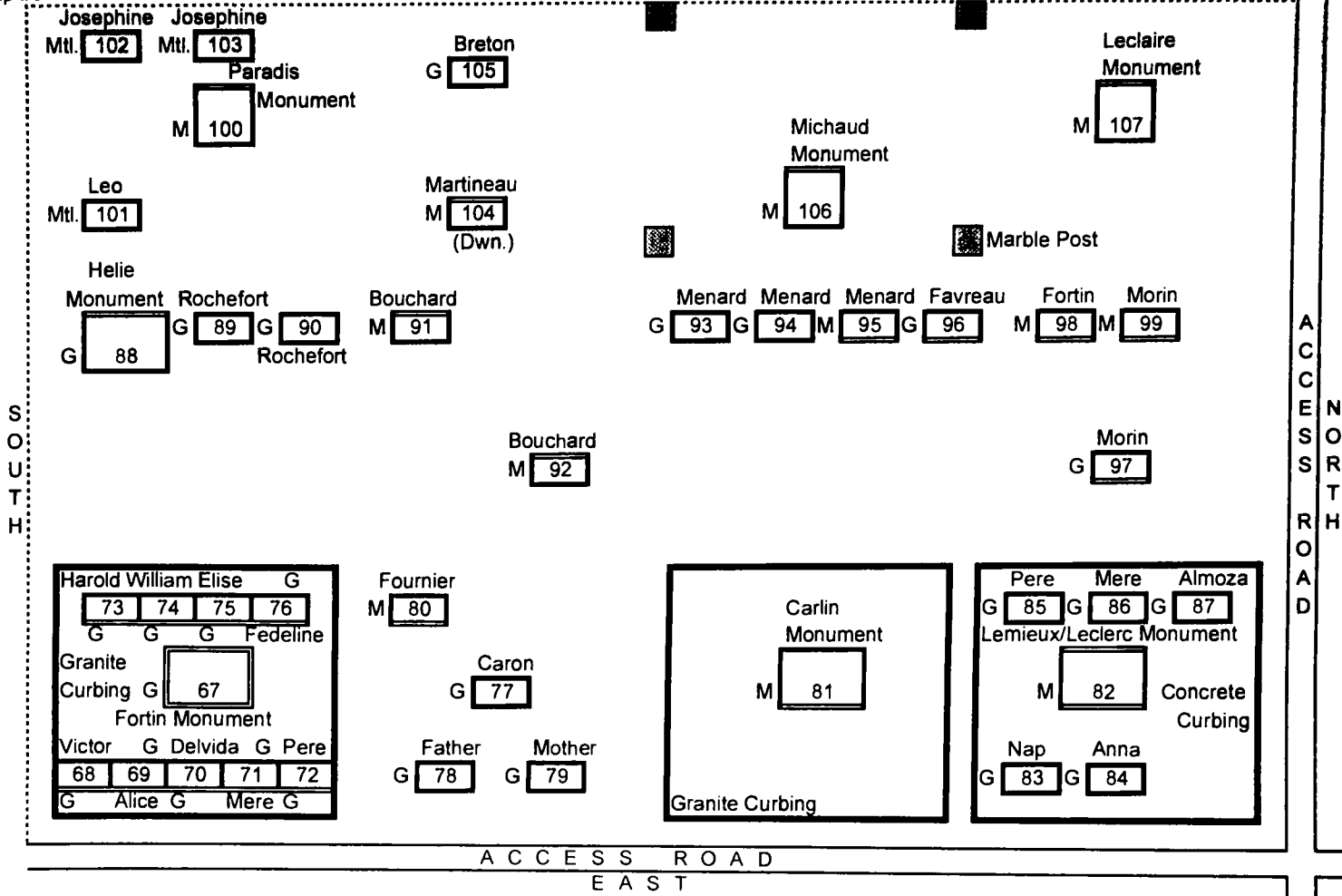

Josephine Josephine

Mtl. **102**

Mtl. **103**

Paradis Monument

M **100**

Breton

G **105**

Leclaire

Monument

M **107**

Michaud

Monument

M **106**

Leo

Mtl. **101**

Martineau

M **104**

(Dwn.)

Marble Post

Helie

Monument

G **88**

Rochefort

G **89**

G **90**

Rochefort

Bouchard

M **91**

Menard

G **93**

Menard

G **94**

Menard

M **95**

Favreau

G **96**

Fortin

M **98**

Morin

M **99**

Bouchard

M **92**

Morin

G **97**

Harold William Elise G

73 **74** **75** **76**

G G G Fedeline

Granite

Curbing G

67

Fortin Monument

Victor

G Delvida

G Pere

68

69 **70** **71** **72**

G Alice

G Mere

G

Fournier

M **80**

Caron

G **77**

Father

G **78**

Mother

G **79**

Carlin

Monument

M **81**

Granite Curbing

Pere

G **85**

Mere

G **86**

Almoza

G **87**

Lemieux/Leclerc Monument

M **82**

Concrete Curbing

Nap

G **83**

Anna

G **84**

A C C E S S R O A D

E A S T

A C C E S S R O A D

ST. JOHN THE BAPTIST CEMETERY - Range Layout

RANGE #12

Map #4

WEST

ACCESS ROAD

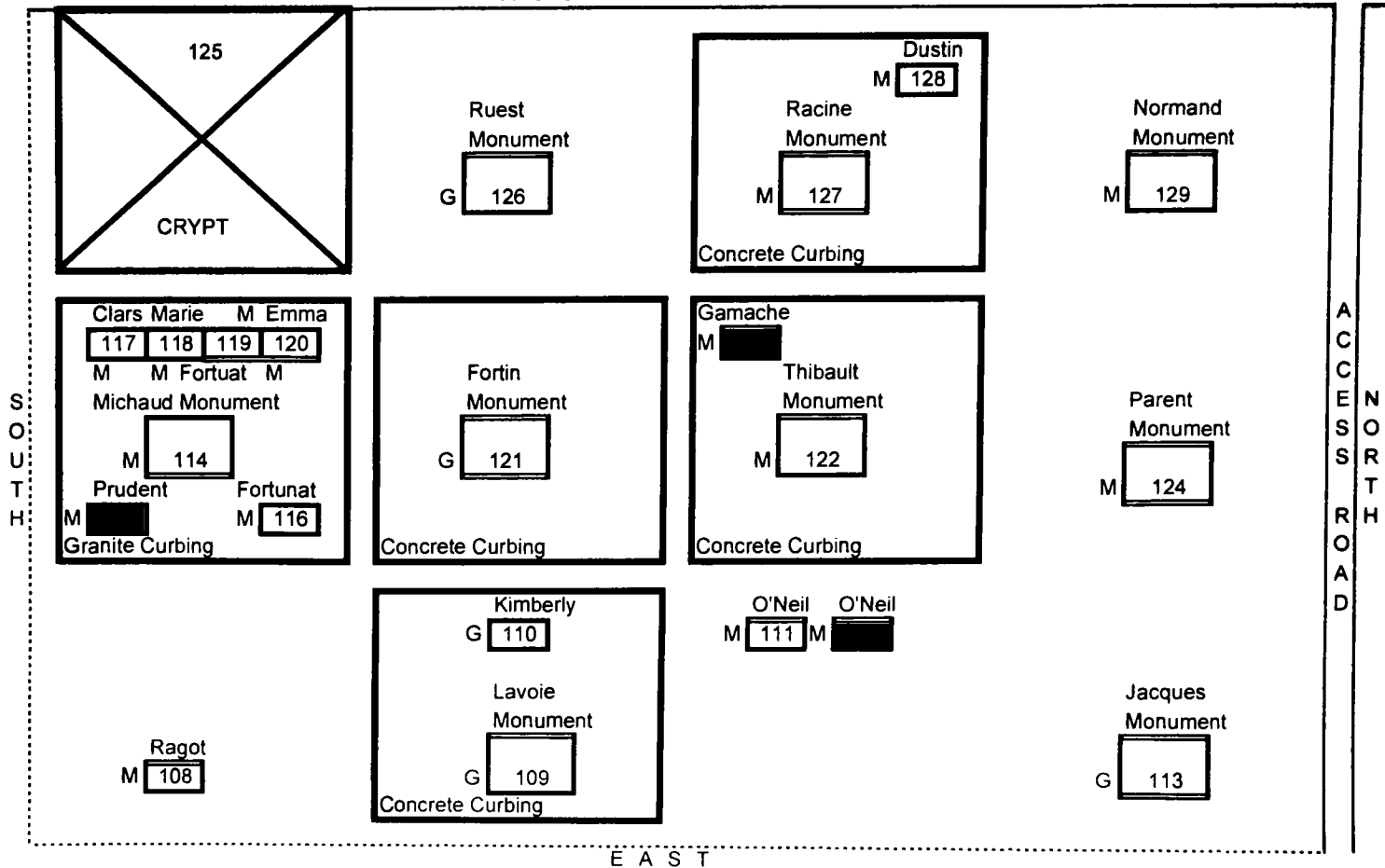

EAST

ACCESS ROAD

SOUTH

RANGE #12

(R12#1) Fortin Monument

South Face:

LEON J. FORTIN
1892 1960

North Face:

His wife
ROSANNA MENARD
1890 - 1976

Marker Stones:

(R12#2) MOTHER

(R12#3) FATHER

(R12#4) Gamache Monument

East Face:

IHS
G
ELISE DESJARDINS
epouse de LOUIS GAMACHE
decedee le 6 Mars 1915
a l'age de 64 ans
priez pour elle
MARIA LOUISE GAMACHE
decedee le 3 Fevrier 1915
a l'age de 24 ans
priez pour elle
GAMACHE

South Face:

ADELARD
1875 - 1875
THOMAS
1886 - 1888

North Face:

LOUIS
1884 - 1885
PIERRE
1893 - 1893

(R12#5)

LACHARITE
PHILUCLESE MATHILDA
1879 - 1961 1877 - 1959

(R12#6)

LUCIEN J. LACHARITE
June 26, 1915
October 18, 1974

(R12#7)

EUGENE CAOQUETTE
1883 - 1956

(R12#8)

ZEPHIRINE LAVALLEE
1877 - 1950

(R12#9)

Ici repose le corps de
EMILE CAOQUETTE
decedee
le 28 Nov. 1901.
a l'age de 14 ans.

(R12#10) East Face:

DEMERISE GAMACHE
decedee
21 Sept. 1909
a l'age de 64 ans
epouse de
MICHEL CAOUCETTE
ne le 7 Oct. 1843
decedee le 15 Dec. 1913

West Face:

WILFRID CAOUCETTE
ne le 29 Nov. 1878
decedee le 1 Juillet 1913
epoux de
DELIA DOUSTOU
ne le 22 Mar. 1877
decedee le 30 Oct. 1907

(R12#11)

Ici repose le corps
ARTHEMISE BOULE
epouse de
DESIRE GAMACHE
decede le 27 Novembre 1887
age de 44 ans
HIRM A. fille de
DESIRI GAMACHE
et de CLEMENTINE CLOUTIER
decede le 30 May 1891
age de 15 mois
Priez pour elles

(R12#12)

ADELARD J. CAOUCETTE
1885 - 1969

(R12#13) St. Onge Monument

South Face:

ST. ONGE

North Face:

GEORGE ST. ONGE, fils
30 Mai 1884 - 28 Mai 1957
son epouse
DELIA M. TARDIFF
10 Nov. 1884 - 15 Janv. 1969

(R12#14) Brillant Monument

West Face:

BRILLANT

East Face:

ELZEBERT BRILLANT
1861 - 1929
son epouse
HERMINE GAMACHE
1858 - 1936
YVONNE BRILLANT
1893 - 1918
PIERRE GAMACHE
1845 - 1918
ALICE BRILLANT
1891 - 1894

M. ALMA E. GEORGE L. ADOLPH FLORILDA
enfants de E. & H. BRILLANT

Marker Stones:

(R12#15) Top of stone:

M. ALMA

Face of stone:

enfant de
ELZEBERT BRILLANT
decede le 4 Mars. 1884
a l'age de un mois et
6 jours

(R12#16) Top of stone:

E. GEORGE

Face of stone:

enfant de
ELZEBERT BRILLANT
decede le 18 Mars 1885
a l'age de un mois

(Marker Stones Cont'd.)

(R12#17) Top of stone:

L. ADOLPH

Face of stone:

enfant de
ELZEBERT BRILLANT
decede le 10 Mars. 1885
age de un mois

(R12#18)

YVONNE BRILLANT
epouse de
JOSEPH A. BOIS
1893 - 1918

(R12#19) Lachance Monument

East Face:

Holy Mother pray for us
LACHANCE

West Face:

A la memoire de la famille
OCTAVE LACHANCE

Marker Stone:

(R12#20)

EVA LACHANCE
June 13, 1896 - Feb. 22, 19
wife of
EDMOND LACHANCE S

(R12#21) Caron Monument

IHS

ALFRED LOUIS CARON
1864 - 1923
CARON

Marker Stones:

(R12#22)

LUCIEN NAPOLEON CARON
Maine
T Sgt US Air Force
World War II
Dec 5 1912 March 11 1961

(R12#23)

MERE
1866 - 1956

(R12#24)

PERE

(R12#26)

SIMONE
1895 - 1973

(R12#25)

MARIE ANNE
1890 - 1936

(R12#27)

ARMAND N
1893 - 1966

(R12#28) Caron Monument

South Face:

A la douce
in memoire de
LOUIS ELISEE CARON
1826 - 1899
HERMINE PARADIS
son epouse
1836 - 1904
CARON

East Face:

ATHANAST
Mai - Aout 1883
LOUIS PHILIPPE CARD
1867 - 1949
FABIOLA SOUCY
son epouse
1875 - 1948

(R12#28) (Caron Monument Cont'd.)

North Face:

MINNIE CARON PARENT
1875 - 1952
GERARDO her son
1908 - 1968

West Face:

DIANA
epouse de
LOUIS P. V. CARON
1868 - 1911

(R12#29) Normand Monument

East Face:

PIERRE
died Aug. 30, 1887
Ae. 16 yrs. 11 dys.
JOSEPH
died June 28, 1890
Ae. 18 yrs.
CHARLES
died June 24, 1897
Ae. 19 yrs. 3 mos.
R. I. P.
sons of LOUIS & JULIA
NORMAND

South Face:

LOUIS Z.
NORMAND
died Sept. 30, 1909
Ae. 67 yrs.
NORMAND

Marker Stones:

(R12#30) East Face:

MARI DIANA
West Face:
fills de
LOUIS et JEULI
NORMAND
mort de 21 Mar. 1876
age de 2 mois et 18 jour

(R12#31) East Face:

MOTHER
West Face:
FATHER

(R12#32) Normand Monument

NORMAND

Marker Stones:

(R12#33) GEOFFREY J.
1892 - 1950

(R12#34) LAURA NORMAND
1893 - 1983

(R12#35) Paradis Monument

West Face:

Ici repose le corps de
TELESPHORE
PARADIS
decede le 22 Sept. 1923
a l'age de 64 ans.
son epouse
DERILDA
NORMAND
decedee le 21 Janvier 1929
a l'age de 59 ans 10 mois
PARADIS

East Face:

LOUSE BEAULIEU
epouse de
TELESPHORE PARADIS
1860 - 1884
JEAN M. ST. PIERRE
1893 - 1954
LUCIA son epouse
1896 - 1959

Marker Stone:

(R12#36)

JEAN M
ST. PIERRE
Maine
PFC
Co C 326 Infant
World War I
September 6 1893
April 17 1954

(R12#37) VICTORIA CARON
1880 - 1940

(R12#38) Beaugard Monument

South Face:

PIERE GAMAISH
died Aug. 20, 1887
age 67 yrs.
MARIE A. MARCOU
his wife
died Aug. 1, 1880
age 59 yrs.
CATHERINE
GAMAISH
died Apr. 21, 1871
age 11 yrs. 8 mos.
ANASTASIE
MEUNIC
wife of
FRANCOI MARCOUS
died Aug. 6, 1898
age 99 yrs. 8 mos.
BEAUREGARD

East Face:

LUCIE
BEAUREGARD
1849 - 1924
CHARLES E.
BEAUREGARD
1900 - 1963
his wife
CECILIA
DUCHARME
1901 - 1963
BEAUREGARD

North Face:

PHILEAS H.
BEAUREGARD
died Apr. 8. 1895
age 4 mos.

Marker Stones:

(R12#39) CECILIA BEAUREGARD
1901 - 1963

(R12#40) CHARLES E. BEAUREGARD
1900 - 1963

(R12#41) ROGER LOUIS PINETTE
1951 - 1952

(R12#42) Caron Monument

West Face:

FRANCOIS CARON
1821 - 1891
son epouse
CESARIE CARON
1834 - 1895
OLIVE CARON
1827 - 1889
CALIXTE CARON
1863 - 1926
O. CARON

South Face:

MARIE
ALMA
enfant dau. de
ALFRED &
ADELLE CARON
1891

East Face:

ONESIME CARON
1857 -
LAETITIA CARON
1874 -

(R12#43) Lemieux / Michaud Monument

East Face:

EUGENE LEMIEUX
1832 - 1904
son epouse
1831 SEVERANCE 1890
1874 AUGUSTE 1889
1858 LOUIS 1923
1869 EUGENIE 1930

West Face:

PATRICK MICHAUD Sr.
1871 - 1948
son epouse
1872 ADELIA 1951
BERNADETTE MICHAUD
1900 - 1923
DELIA E. TETREULT
1896 - 1981

(R12#44) Dufresne Monument

West Face:

DUFRESNE
JOSEPH DUFRESNE
Apr. 18, 1845 - Dec. 2, 1907
MARIE GAMACHE
son epouse
June 10, 1854 - Aug. 15, 1921
ROSE ANNA DUFRESNE
Oct. 20, 1875 - Apr. 4, 1927

East Face:

HELENE DUFRESNE
1885 - 1942
MARIE ANNE DUFRESNE
1891 - 1918
ALFRED DUFRESNE
1890 - 1934
son epouse
LEDA LETARTE
1886 - 1959
leur fils
PAUL ALFRED
1923 -

Marker Stones:

(R12#45)

J. A. EDWARD
DUFRESNE
decede le 7, Oct. 1899
agee de 8 mois 2 jours

(R12#46)

JOSEPH ADELARD
DUFRESNE
decede le 17 Nov. 1895
agee de un mois

(R12#47)

GEORGE
fils de
HARRY & ALEXIN.
DUFRESNE
1905 - 1909

(Marker Stones Cont'd.)

(R12#48) MARIA HELENE
DUFRESNE
decede le 4 Dec. 1881
age de 9 mois 4 jours

(R12#49) ALEXANDER J NADEAU
Maine
Pvt 82 General Hosp
World War II
Sept 2 1902 June 26 1966

Marker: U.S. Veteran

(R12#51) Morin Monument

West Face:

EUGENE D. MORIN
1851 - 1936
CORDELIA BENOIT son epouse
1851 - 1882
AMELIA J. LEBEL son epouse
1861 - 1932
MORIN

East Face:

Enfants de E. D. & A. L. MORIN
PIERRE EUGENE ALCIDES
1887 - 1890
MARIE EMILIE BERTHE
1889 - 1890
JOSEPH THOMAS ROLAND
1893 - 1899
MAURICE MORIN
1898 - 1962
JULIETTE MORIN
1892 - 1963
ADRIENNE
1900 - 1983
LUCILE
1902 - 1988
PIERRE MORIN Sr.
1825 - 1904

(R12#54) J. B. EIZEAR
son of
LOUIS & HELENE
TRUDEAU
died Sept. 1, 1878
aged 1 mo. 12 ds.

(R12#50) WILLIAM JOSEPH
son of
WM. & CATHARINE
PETERSON
died Nov. 21, 1882
aged 3 yrs.

(R12#52) Trudeau Monument

East Face:

TRUDEAU

West Face:

LOUIS G. TRUDEAU
1849 - 1907
his wife
HELENE M. DELAGASSE
1854 - 1907
TRUDEAU

Marker Stones:

(R12#53) JOHN O. Z.
son of
LEWIS & ELLEN
TRUDEAU.
died June 8, 1882
aged 1 mo. 2 d's

(R12#55) OLIVIER Z.
son of
LOUIS & HELENE
TRUDEAU
died Apr. 6, 1881
aged 1 y'r 8 mos. 17 d's.

(Marker Stones Cont'd.)

(R12#56)

J. M. WILFRIED.
son of
LOUIS & HELENE
TRUDEAU
died Mar. 4, 1885
aged 7 mos. 3 d's.

(R12#57)

J. P. ALBERT
son of
LOUIS & HELENE
TRUDEAU
died Dec. 22, 1885
aged 2 yrs. 4 mos.

(R12#58)

M. L. SYLVIA.
dau. of
LOUIS & HELENE
TRUDEAU.
died Mar. 7, 1891
aged 3 yrs. 7 mos.

(R12#59) Dolan Monument

West Face:

JAMES DOLAN
1825 - 1898

ELIZABETH OWENS his wife
1824 - 1911
DOLAN

East Face:

ELIZABETH E. DOLAN
1868 - 1922

THOMAS E. DOLAN
1858 - 1932

JOSEPH P. DOLAN
1873 - 1943

North Face:

CATHERINE
1870 - 1879

Marker Stones:

(R12#60)

FATHER

(R12#61)

MOTHER

(R12#62)

CATHERINE

(R12#63)

JOSEPH

(R12#64)

LIZZIE

(R12#65)

TED

(R12#66)

MARY MURPHY
1831 - 1903

(R12#67) Fortin Monument

East Face:

AUGUSTE J. FORTIN
1852 - 1918

FEDELINE BERGER
1852 - 1936
FORTIN

South Face:

VICTOR L. FORTIN
1894 - 1967

ALICE G. FORTIN
1903 - 1990

(R12#67 Fortin Monument Cont'd.)

West Face:

FEDELINE FORTIN
1876 - 1933
DELVIDA J. FORTIN
1879 - 1939
HAROLD R. THALHEIMER
1924 - 1991
ALICE F. THALHEIMER
1927 -

North Face:

WILLIAM S.
BOURASSA
1911 - 1982
ELISE A.
BOURASSA
1911 - 1978

Marker Stones:

(R12#68)	VICTOR	(R12#69)	ALICE	(R12#70)	DELVIDA
(R12#71)	MERE	(R12#72)	PERE	(R12#73)	HAROLD
(R12#74)	WILLIAM	(R12#75)	ELISE	(R12#76)	FEDELINE

(R12#77)

CARON
SIMEON ALMA
1874 - 1951 1875 - 1952
LIONEL VENISE
1911 - 1978 1905 - 1983

(R12#78) FATHER

(R12#79) MOTHER

(R12#80) Top of stone:

YVONNE

Face of stone:

en memoire de
YVONNE
enfant regretter
d'
CLEOPHAS et PHELONISE
FOURNIER
decedee le
28 Aout 1891
agee de 8 mois 11 jours

(R12#81) Carlin Monument

JOSEPH A. CARLIN
1864 - 1947
his wife
SARAH WADDINGTON
1860 - 1941
CARLIN

(R12#82) Lemieux / Leclerc Monument

East Face:

LEMIEUX
NAPOLEON LEMIEUX
1854 - 1922
son epouse
ANNACLETT THEBERGE
1866 - 1943
ALBERT LEMIEUX
1893 -

West Face:

LECLERC
a la memoire
JOHN LECLERC
1868 - 1930
son epouse
BEATRICE THEBERGE
1869 - 1932
ALMOZA LECLERC
1910 - 1980

Marker Stones:

(R12#83) NAP LEMIEUX
1854 - 1922

(R12#85) PERE

(R12#87) ALMOZA

(R12#84) ANNACLETT
LEMIEUX
1866 - 1943

(R12#86) MERE

(R12#88) Helie Monument

HELIE
ALICE R. ARMAND O.
1898 - 1957 1899 - 1985

(R12#89) ELEANORE
ROCHEFORT
1863 - 1937

(R12#90) STANISLAUS
ROCHEFORT
1860 - 1935

(R12#91) Ici
repose le corps de
CLERINA
enfant de
JOSEPH BOUCHARD
decede
le 4 Mai 1899.
a l'age de
3 ans 9 mois 12 jours

(R12#92) Ici repose le corps de
NOE BOUCHARD
epouse de
HERMINE DUPUIS
decede
le 2 Mars 1896,
age de 47 ans 4 mois
et 23 jours

(R12#93) DELIA C. MENARD
May 10, 1900 Dec. 28, 1982

(R12#94) JOSEPH V MENARD
Maine
PFC Co D115 Infantry
World War I
June 2, 1893 July 6, 1958

(R12#95)

NAPOLEON J.
MENARD

-
Maine

-
Pvt. Med. Dept.
July 24, 1942

Marker: U.S. Veteran

(R12#96)

RUSSELL P. FAVREAU
Apr. 28, 1929 -
PHYLLIS MENARD FAVREAU
June 5, 1929 - Jan. 31, 2006

(R12#97)

MORIN
BERNADETTE L. JOSEPH F.
1894 - 1966 1892 - 1988

(R12#98)

Ici repose le corps de
DIANA FORTIN
decede
le 26 Dec. 1890
a l'age de 18 ans et
8 mois
Parents et amies priez pour elle

(R12#99)

Ici repose le corps de enfants de
ARTHAIME et ESILDA MORIN
JOSEPH ARTURE
decede le 9 Joul 1890
a l'age de 11 mois et 20 jour
MARIE DIANA
decede le 8 Sept. 1891
a l'age de 9 mois
MARIE CECILE
decede le 10 Aout 1907
a l'age de 4 mois
JOSEPH ROSAIRIO
decede le 14 Feb 1911
a l'age de 6 ans et 9 mois

(R12#100) Paradis Monument

ALFRED A.
PARADIS
1863 -
son epouse
JOSEPHINE
1864 -
leur fille
YVONNE
1899 - 1920
PARADIS

Marker Stones:

(R12#101)

LEO J. PARADIS
1897 - 1942

(R12#102)

JOSEPHINE E. BELANGIER
1904 - 1956

(R12#104)

Ici
repose le corps
de
DELLE MARIE MARTINEAU
decedee
le 30 Avril 1890
a l'age de
.... ans et deux mois
Priez pour elle

(R12#103)

JOSEPHINE PARADIS
1864 - 1946

(R12#105)

BRETON
ELISE BILODEAU
Dec. 21, 1857
Apr. 2, 1942
J. T. AIME
May 1, 1852 Aug. 3, 1892
thier son

JOSEPH "JOE"
Jan. 27, 1872
Sept. 21, 1910
W. WILFRED
June 3, 1890 Oct. 28, 1898

(R12#106) Michaud Monument

Top of stone:
JOSEPH W. MICHAUD
Face of stone:
Ci Git
ODELIE MICHAUD
ne le 25 Dec. 1874
decedee le 3.d Aout 1890
a l'age de 15 ans. et 7 mois
et 3 jours.

(R12#107) Leclair Monument

IHS
Ci - Git
LOUIS LECLAIRE
decede le 6 Janv. 1887
agee de 26 ans et 3 mois
MARIE CATHERINE CHARTIER
decedee le 2 Juin 1887
agee de 60 ans et 1 mois
et son epoux
DAVID LECLAIRE
decede le 3 Fev. 1890
a l'age de 61 ans et 7 mois
R. I. P.

(R12#108)

CHARLES SEBASTIEN
fils de
HENRY & GEORGINA RAGOT
decede
le 24 Septembre 1886
a l'age de 3 ans.

(R12#109) Lavoie Monument

LAVOIE
REGINA **JOSEPH J.**
1893 - 1979 1895 - 1961

(R12#111)

ANTHONY O'NEIL
Co. G.
32 Me. Inf.

Marker Stone:
(R12#110)

KIMBERLY DIANE
Oct. 16, 1975 - Dec. 25, 1975
Infant daughter of
NANCY A. LAVOIE
In loving memory

(R12#112)

MICHAEL D.
died Apr. 16, 1871.
Aet. 1 year 2 mos.
JAMES R.
died July 26, 1874.
Aet. 6 weeks 4 ds.
children of
ANTHONY & CATHERINE
O'NEIL

(R12#113) Jacques Monument

West Face:
JACQUES
East Face:
1889 **ALFRED J. JACQUES** 1900
1896 **IDA J. his wife** 1900
1861 **CHARLES JACQUES** 1900
1856 **JULIE his wife** 1900

(R12#114) Michaud Monument

1863 FORTUNAT MICHAUD 1935
1863 PRUDENT MICHAUD 1916
1852 GRACE MICHAUD 1884
1866 EMMA MICHAUD 1932
1894 FORTUNAT J. MICHAUD 1936
1868 CLARA CLOUTIER 1942
1864 MARIE S. GRENIER 1944
MICHAUD

(R12#121) Fortin Monument

West Face:

ROMUALD B. FORTIN
1879 - 1934
son epouse
ADELIA BERNIER
1881 - 1916
1877 DELIA FOREST FORTIN 1963
FORTIN

East Face:

MARIO J. FORTIN
1910 - 1969
son epouse
DOROTHY LEBOURDAIS
1910 - 2007

(R12#122) Thibault Monument

Ici repose le corps de
CLEOPHAS
THIBAUT
ne 17, Dec. 1857
decede 16, Sept. 1914
son epouse
EMMA GAMACHE
1869 - 1958
WIFRED THIBAUT
1892 - 1951
THIBAUT

Marker Stones:

(R12#115) Top of stone:
PRUDENT
Face of stone:
ne, le 21 Mai 1863
mort, le 16 Mars 1916

(R12#116) Top of stone:
FORTUNAT
Face of stone:
ne, le 21 Mai 1863
mort, le 5 Jan. 1935

(R12#117) Top of stone:
CLARA
Face of stone:
nee le 10 May 1868
morte le 3 Aug. 1942

(R12#118) Top of stone:
MARIE
Face of stone:
nee le 27 Sept. 1864
morte le 22 July 1944

(R12#119) FORTUNAT
JOSEPH
MICHAUD
-
Maine
-
Pvt 36 Inf 12 Div
June 12 1936
Marker: U.S. Veteran

(R12#120) Top of stone:
EMMA
Face of stone:
nee le 15 Oct. 1866
morte le 8 Feb. 1932

Marker Stone:

(R12#123) Priez pour l'ame
de
MARGUERITE LAMARD
epouse de
BLAISE GAMACHE
decedee
le 15 Septre 1894
agee de 59 ans.

(R12#124) Parent Monument

West Face:

JOHN PARENT
1846 - 1934
his wife
LUCY A. BESAW
1852 - 1930
PARENT

East Face:

1876 JOHNNIE H. 1877
1872 HARRY E. 1873
1889 ALICE 1903
1885 LUCY A. 1948

(R12#125) Crypt:

H. S.
ALEXIS Ste MARIE

Pere
ALEXIS
decede
le 10 Mars 1913
agee
de 60 ans.

J. A. ALBERT
decede
le 12 Avril 1886
a l'age de
8 ans et 2 jours

HENRY STE. MARIE
died
March 11, 1974
R. I. P.

Mere
ELISE
decedee
le 20 Mai 1893
agee
de 36 ans et 9 mois

M. A. CLAIRE
decedee
le 12 Avril 1886
a l'age de
2 ans 25 jours

LUCIA STE. MARIE
decedee
le 18 Dec. 1956
R. I. P.

CLAIRE STE. MARIE
died
Aug. 28, 1983
R. I. P.

OLEVINE TRUDEAU
epouse de
E. McLEMORE
decedee le 2 Janvier 1929
a Walpole, Mass.
R. I. P.

ALICE STE. MARIE
epouse de
J. N. KEARNS
decedee le 18 Janvier 1935
a Montreal P. Q.
R. I. P.

LOUIS TRUDEAU
epouse de
EMELIE BAZINET
ne le 25 Aout 1821
decede le 14 Janvier 1909

EMMA STE. MARIE
epouse de
ORVILLE J. TRUDEAU
decedee le 14 Juin 1938

FLORILDA STE. MARIE
decede le 8 Jan. 1946
R. I. P.

EMELIE BAZINET
epouse de
LOUIS TRUDEAU
nee le 9 de Juin 1830
decedee le 2 Fevrier 1906

(R12#126) Ruest Monument

RUEST
JOSEPH ANNIE
1885 - 1957 1886 - 1984

(R12#127) Racine Monument

West Face:

**FATHER
&
MOTHER
RACINE**

East Face:

**PRUDENT RACINE
1846 -
HELEN son epouse
1844 - 1920**

Marker Stone:

(R12#128)

**JOSEPHINE RACINE
DUSTIN
1880 - 1957**

(R12#129) Normand Monument

RIP

LEONCE NORMAND

1888 - 1974

EMILIA LACHANCE

son epouse

1892 - 1930

leur enfant

JOSEPH 1930 - 1930

NORMAND

ST. JOHN THE BAPTIST CEMETERY - Range Layout

RANGE #13
Map #1

WEST

A
C
C
E
S
S
R
O
A
D

N
O
R
T
H

Concrete Curbing

Derocher
M 35

Michaud Monument

M 36

Concrete Curbing

Pere M 37 Mere M 38 Pere M 39

Stuart M 40 Stuart M 41 Stuart M 42

Father M 23 Arthur M ██████ Saindon Monument

Mother M 22 M 19

Philip G 21 Marie G 20

Granite Curbing

Poitras Monument

M 25

Granite Curbing

Alice M 29 Jean M 30 Pere M ██████

Ruest Monument

M 26

Joseph M 27 Mere M 28

Granite Curbing

Caron M ██████ Concrete Cross

Ducharme Monument

G 32

Belanger Monument

M 1

Landry G 7 Landry M 8

Longtin Monument

G 14 Catherine G 9 Lorenzo G ██████

Julien Florien Lorenzo G 10 11 12 13

M G Demerise

Concrete Curbing

Brilliant Monument

G 16 Concrete Curbing

Emeric/Emma G ██████ Lorenzo/Albertine G 18

Rose G 2 Gaudias G 3 Joseph G 4 Pere G 5 Mere G 6

Concrete Cross

A C C E S S R O A D
E A S T

ST. JOHN THE BAPTIST CEMETERY - Range Layout

RANGE #13
Map #2

WEST
ACCESS ROAD

SOUTH
ROAD

NORTH

Concrete Curbing
Lamarre
Monument
M 59
Pere Mere Louis Joseph
M 60 61 62 63 M
M M

Concrete Curbing Bois
G 65
Morin
G 64

Mere Pere 160-161 Stairs
M 67 68 1904
Mtl. Gaudreau
Monument
M 66 Crucifix

Marble
Post

Doolan
M 58

Bois
G 56
Concrete Curbing

Concrete Curbing
Emma
M 45
Roland Gaudreau
Monument
G 43 M 43

Ritchie Ritchie Ritchie
M 48 M 49 M 50
Concrete Curbing
Ritchie Frazier
46 G 47
Mtl.

Michelle Raymond Chris
G 53 G 54 G 55

Dionne
Monument
G 51

Reid
Monument
G 52

Concrete Curbing

EAST

ST. JOHN THE BAPTIST CEMETERY - Range Layout

RANGE #13
Map #3

W E S T

S
O
U
T
H

N
O
R
T
H

Fortin
Monument
G 89

Monaghan
Monument
G 90
Granite Curbing

Gamache Monument
G 94 Joseph M 91 Octave G 95
Napoleon M 92 Blanche G 93
Granite Curbing

Morreau
M 96

Albert G 80
Parent
Monument
G 79
Granite Curbing

Derocher G 84 Thibeault
Monument M 81
Albina G 82 Adelard G 83
Concrete Curbing

McManus M 85 McManus M 86 McManus M 87

Guerette / Marquis
Monument
M 88
Concrete Curbing

Marquis M 69 Marquis M 70
Marquis G []

Drapeau
Monument
G 72
Granite Curbing

Roy / Drapeau
Monument
G 73
Eudore G 74
Granite Curbing

Granite Curbing
Thibeault Monument
M 75
Pere M 76 Mere M 77 Prohon G 78

A C C E S S R O A D

E A S T

ST. JOHN THE BAPTIST CEMETERY - Range Layout

RANGE #13

Map #4

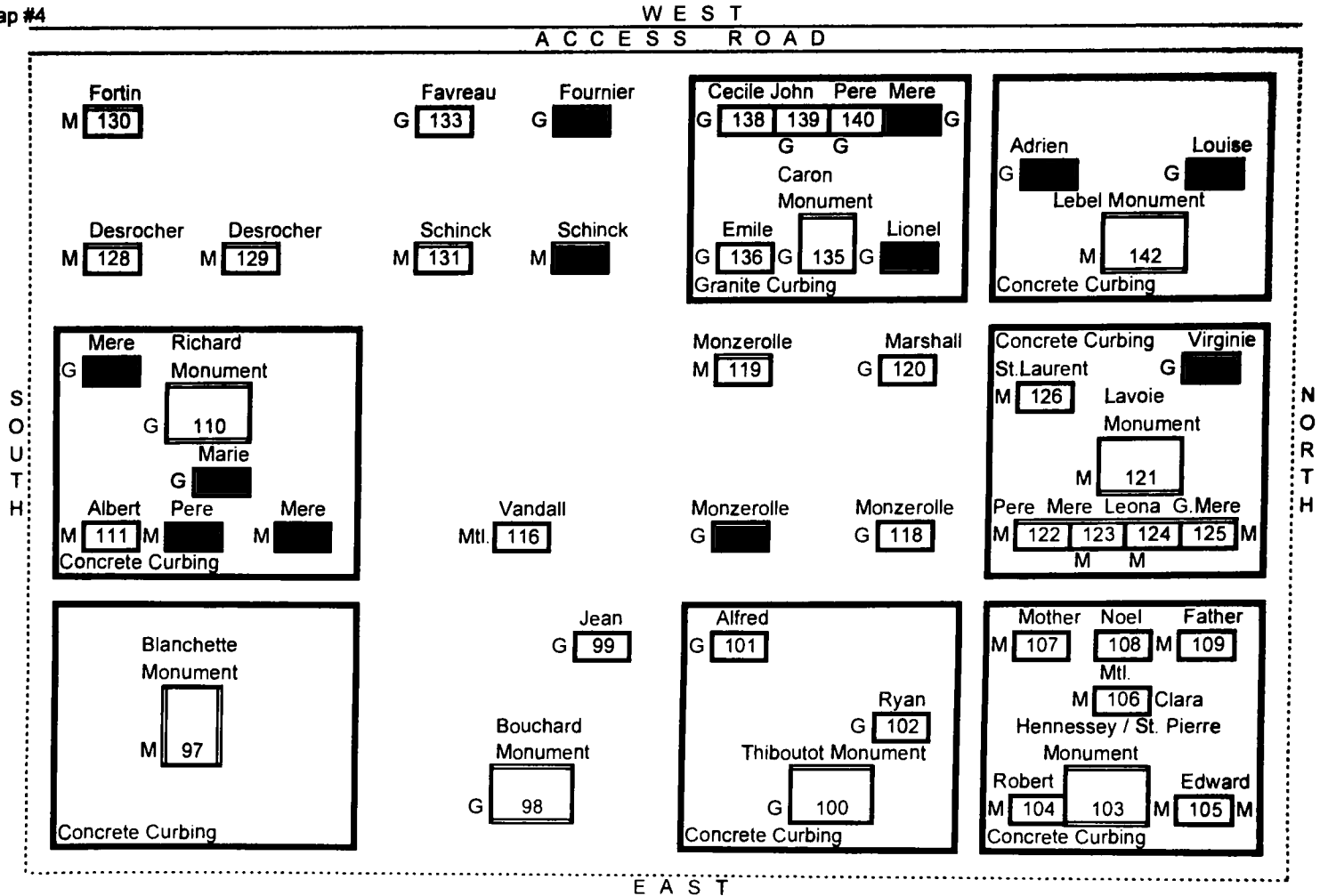

ST. JOHN THE BAPTIST CEMETERY - Range Layout

RANGE #13

Map #5

W E S T

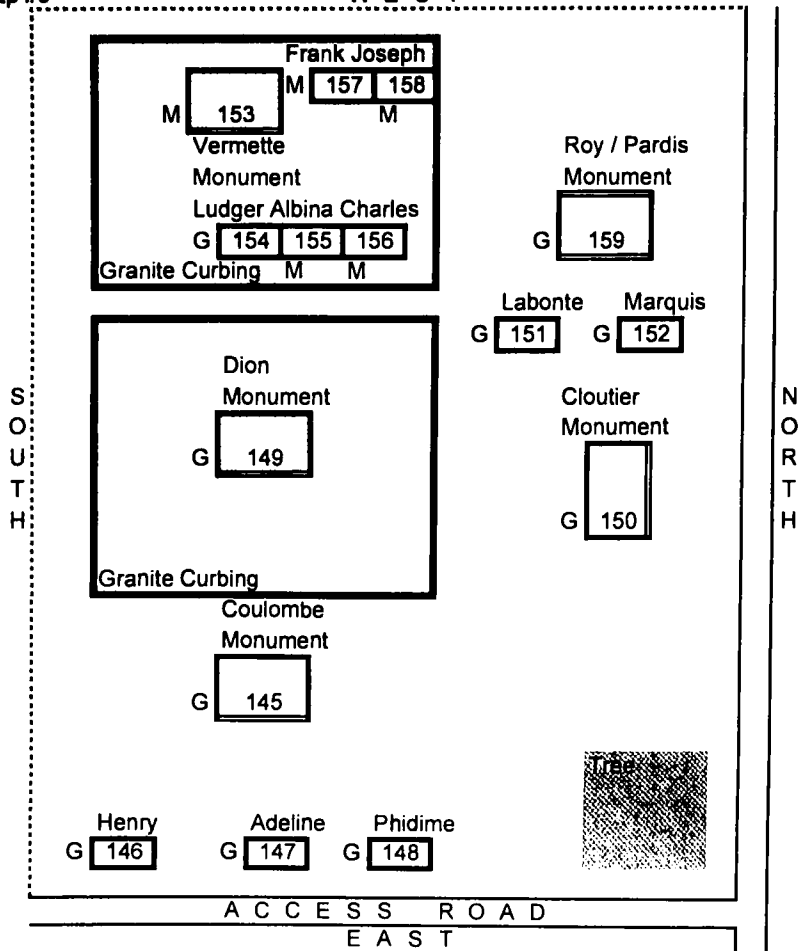

ST. JOHN THE BAPTIST CEMETERY - Range Layout

RANGE #13
Map #6

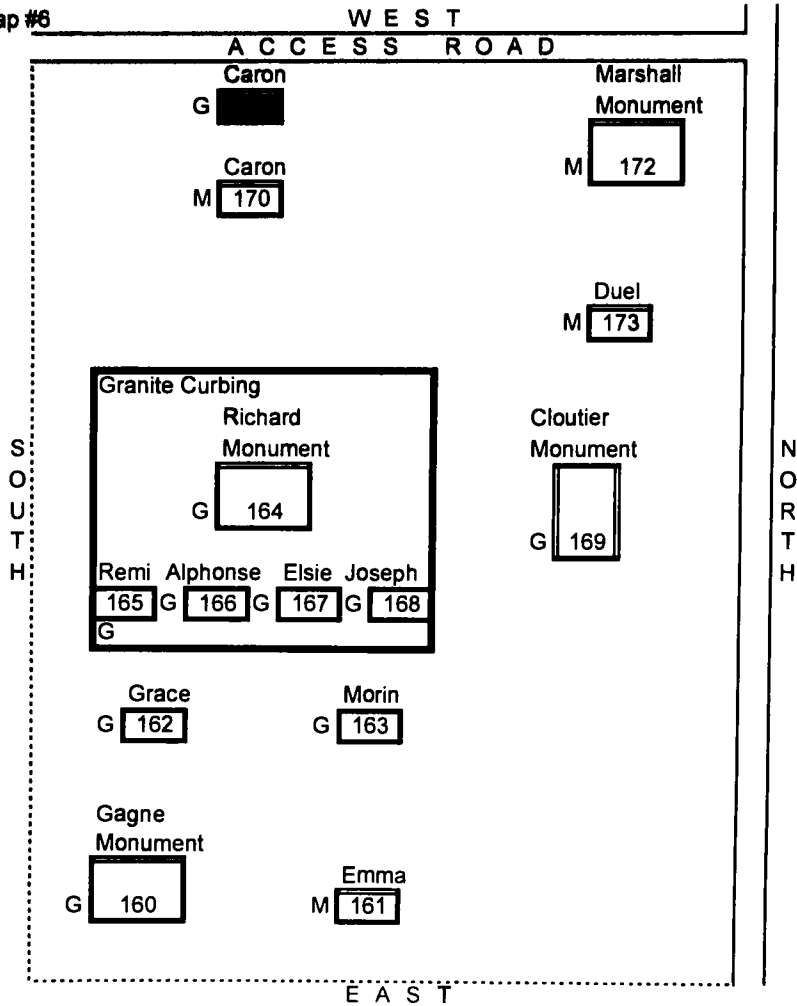

RANGE #13

(R13#1) Belanger Monument

JOSEPH BELANGER
1880 - 1942
son epouse
ALBINA RICHARD
1873 - 1946

Marker Stones:

(R13#2)

ROSE A. BELANGER
GAMACHE
1905 - 1989

(R13#3)

GAUDIAS BELANGER
Pvt US Army
Oct 12 1905 Oct 14 1974

Marker: U.S. Veteran

(R13#4) JOSEPH W. BELANGER Jr.
1904 - 1952

(R13#5)

Pere
DAMASE C.
decede 20, Mars. 1918
a l'age de 65

(R13#6) Mere
MARLE E.
decedee 24 Aout 1947
a l'age de 91

(R13#8)

HARMIDAS
LANDRY
Maine

(R13#7) MARIE BLANCHE LANDRY
Mar. 31, 1890 - Dec. 17, 1970
wife of
HORMIDAS LANDRY

Pvt
23 Co Coast Arty
World War I
September 6 1883
July 17 1954

(R13#9) Longtin Monument

East Face:

L. LONGTIN
May God bless and may thier souls
rest in peace

Marker Stones:

(R13#10)

JULIEN LONGTIN
1869 - 1918

(R13#11)

FLORIEN
LONGTIN

Marker: U.S. Veteran

-
Maine

West Face:

LORENZO LONGTIN
Nov. 8, 1896 - Apr. 24, 1979
DEMERISE MERCIER his wife
Aug. 9, 1898 - Oct. 7, 1952
JULIEN LONGTIN
Aug. 17, 1869 - Sept. 8, 1918
CATHERINE BRILLANT his wife
Dec. 2, 1871 - Sept. 26, 1906
FLORIEN LONGTIN
June 29, 1895 - Sept. 11, 1918
died in U.S. Army

(R13#12)

LORENZO LONGTIN
Pvt US Army
World War I
1896 - 1979

(R13#13)

DEMERISE MERCIER
LONGTIN
1898 - 1952

Marker Stones Cont'd.:

**(R13#14) CATHERINE BRILLANT
LONGTIN
1871 - 1906**

**(R13#15) LORENZO LONGTIN
1896 - 1979**

**(R13#16) Brilliant Monument
BRILLIANT
1929**

Marker Stones:

**(R13#17) EMERIC BRILLIANT
1862 - 1950
son epouse
EMMA TREMBLAY
1862 - 1932**

**(R13#18) LORENZO BRILLANT
1892 - 1975
epouse
ALBERTINE ALLARD
1897 - 1970**

(R13#19) Saindon Monument

**IHS
ALPHONSE SAINDON
1853 - 1932
HENRIETTE LEBEL wife of
ALPHONSE SAINDON
1858 - 1927
Pvt. ARTHUR SAINDON
Co. F. 26th Inf. 1st Div.
died in France Oct. 4, 1918
age 32 yrs.
SAINDON**

Marker Stones:

**(R13#20) MARIE A. TARDIF
1897 - 1968**

**(R13#21) PHILIP TARDIF
1898 -**

(R13#22) MOTHER

(R13#23) FATHER

**(R13#24) ARTHUR
SAINDON**

**-
Maine**

**-
Pvt. 26 Inf.
1 Div.
October 4, 1918**

(R13#25) Poitras Monument

**MATHIAS POITRAS
1841 - 1901
POITRAS**

(R13#26) Ruest Monument

South Face:

Ici repose le corps de
OCTAVE RUEST
decede 25 Mars 1958
a l'age de 80 ans et 8 mois
CLARA DESJARDINS
epouse de
OCTAVE RUEST
decedee le 8 Juillet 1906
a l'age de 26 ans et 4 mois
Ici repose le corps de
JOSEPH RUEST
decede le 21 Aug. 1927
a l'age de 23 ans et 4 mois
Priez pour lui
RUEST

West Face:

Ici repose le corps de
ALFRED
enfant bien aime de
OCTAVE RUEST
et de
CLARA DESJARDINS
decede le 21 Oct 1905
a l'age de 2 mois
JEAN MOTARD
1904 - 1996
son epouse
ALICE RUEST
1901 - 1966

Marker Stones:

(R13#27)	JOSEPH	(R13#28)	MERE	(R13#29)	ALICE
	(R13#30)	JEAN	(R13#31)	PERE	

(R13#32) Ducharme Monument

DUCHARME
JOSEPH A.
1892 - 1959
his wife
HELEN CARON
1896 - 1979
"Say a Hail Mary"

Marker Stones:

(R13#33) THEODORE H.
CARON
-
Maine
-
Pvt. 1 Cl.
19 Field Art.
June 12, 1923

(R13#35)

Ici repose le corps de
D. MALVINA DEROCHER
epouse de
DESIRE RONDEAU
decedee le 12 Aout 1912
lage de 65 ans et 2 mois
Priez pour elles

(R13#34) (Concrete cross, no markings)

(R13#36) Michaud Monument

East Face:

Ici repose le corps de
LUDGER MICHAUD
epoux de
JOSEPHINE ST. PIERRE
1878 decede 1936
le 16 de Mars 1905
a l'age de 31 ans et 1 mois
son epoux
ARTHUR MICHAUD
1880 - 1937
MICHAUD

South Face:

JACQUES C.
D'AMOURS
1910 - 1989
son epouse
LUCIENNE J.
MICHAUD
1912 - 1996

Marker Stones:

(R13#37) PERE

(R13#38) MERE

(R13#39) PERE

(R13#40)

THOMAS J.
1885 - 1947
his wife
EMMA M. ALLEN
1890 - 1970
STUART

(R13#41)

S
THOMAS STUART
1822 - 1909
Member Co. D. 5. Regt. Me. Vol.
Infantry
In 32 general engagements
1861 - 1865

(R13#42)

S
THERESA
wife of
THOMAS STUART
1831 - 1907

(R13#43) Gaudreau Monument

West Face:

GAUDREAU
1892 CLARENCE GAUDREAU 1982
son epouse
1891 CEDEA LONGTIN 1962
Mon dieu je vous mon coeur

East Face:

1857 ALFRED GAUDREAU 1912
son epouse
1857 CLAUDIA KIROUAC 1940

Marker Stones:

(R13#44) RONALD A. GAUDREAU
1944 - 1945
enfant de
Mr. et Mme. M. GAUDREAU

(R13#45) East Face:

EMMA COULOMBE
1862 - 1926
West Face:
famille de
ALFRED GAUDREAU
1857 - 1912

(R13#46) WILLIAM RITCHIE
1881 - 1939

(R13#47) ALICE M. FRAZIER
1886 - 1950

(R13#48) JOHNNIE RITCHIE
born
Nov. 22, 1889
died
May 27, 1904

When we see the precious blossom,
that we tended with loving care,
rudely taken from our bosom,
how our hearts all most despair.
Round the little grave we linger,
till the setting sun is low,
feeling all our hopes have vanished,
with the flower we cherished so.

(R13#49) Top of stone:

MOTHER

Face of stone:

MARY A.
wife of

PETER RITCHIE
1842 - 1909

One precious in our hearts is gone,
the voice we loved is stilled.
The place made vacant in our home,
can never more be filled.
Our father in his wisdom called
the boon his love had given;
and though on earth the body lies,
the soul is safe in heaven.

(R13#50) Top of stone:

FATHER

Face of stone:

PETER S. RITCHIE
1830 - 1914

Gone but not forgotten

(R13#51) Dionne Monument

West Face:

DIONNE
Together forever

East Face:

ADELARD J. DIONNE
1912 - 1985

his wife

ELAINE E. BERNIER
1912 - 2003

(R13#52) Reid Monument

West Face:

REID

East Face:

PATRICK S. REID

Jan. 31, 1959 - Sept. 10, 1994

JUDY A. WHITE REID

July 31, 1962

CHRISTOPHER M. REID

Nov. 27, 1984 - Oct. 26, 2001

Marker Stones:

(R13#53) MICHELLE
1971

(R13#54) RAYMOND
1934

(R13#56) BOIS
1868 JOSEPH A. 1950
1870 POMELA G. 1945
At rest

(R13#55) CHRIS
1984 - 2001

(R13#57) Famille
de
J. B. MORIN

(R13#58) SELINA DOOLAN 1872 - 1905

(R13#59) Lamarre Monument

IHS
EDMOND LAMARRE
1855 - 1931
son epouse
CELANIRE THEBERGE
1863 - 1934
LAMARRE

Marker Stones:

(R13#60) PERE

(R13#61) MERE

(R13#62) MARIE LOUISE
LAMARRE
1894 - 1927

(R13#64) Famille
de
J. B. MORIN

(R13#63) JOSEPH
LAMARRE
1889 - 1947

(R13#65) Family of
TELESPHORE
BOIS

(R13#66) Gaudreau Monument
(Life size crucifix)

Ci Git
VIRGINIE BOULAY
decedee
le 18 Juil. 1904
agee de 69 ans. 11 ms.
epouse de
MARC GAUDREAU

(R13#69) CHRISOLOGUE
MARQUIS
decede le 9 Oct. 1905
a l'age de 71 ans et 6 mois

Famille
MARC GAUDREAU
Pere

(R13#70) WILLIAM MARQUIS
Nov. 3, 1866 Jan. 12, 1932
son epouse
PHILAMEN M.
Mar. 18, 1866
MARQUIS

Marker Stones:

(R13#67) MERE

(R13#68) PERE 1876 - 1955

Stairs:

1904
160 - 161

(R13#71) THOMAS MARQUIS
1876 - 1961

(R13#72) Drapeau Monument

East Face:

GEORGE DRAPEAU
1869 - 1952
ALMA LAPOINTE
son epouse
1886 - 1981
DRAPEAU

West Face:

FRANCOIS DRAPEAU
1827 - 1906
ARTHEMISE COUTURIER
son epouse
1829 - 1910

(R13#73) Roy / Drapeau Monument

East Face:

R
G. JOSEPH ROY M.D.
1863 - 1936
IRMA C. LEBEL
son epouse
1859 - 1909
ANTOINETTE LEBEL
son epouse
1869 - 1949
ROY

West Face:

EUDORE
1894 - 1981
MARIE SOPHIE
1895 - 1964
DRAPEAU

South Face:

GERMAINE
1897 - 1898
FABIENNE
1900 - 1914
ALICE
1901 - 1914
BEBE - 1913

Marker: U.S. Veteran

Marker Stone:

(R13#74) EUDORE A DRAPEAU
Sgt US Army
World War I
Mar 2 1894 Jan 4 1981

(R13#75) Thibeault Monument

LOUIS G. THIBEALT
1850 - 1909
AURELIE BOULE
son epouse
1854 - 1910

Marker Stones:

(R13#76) PERE (R13#77) MER
(R13#78) Le PROHON

(R13#79) Parent Monument

West Face:

EUSTAGHE PARENT
PARENT

North Face:

M. ROSE PARENT
1884 - 1885
M. LOUISE PARENT
1886 - 1907
M. EVA PARENT
1888 - 1910

Marker Stone:

(R13#80) ALBERT A PARENT
Virginia
Sgt 4 Field Hospital
World War I
Feb 18 1891 Nov 26 1964

Marker: U.S. Veteran

(R13#81) Thibeault Monument

NAPOLEON THIBAUT
decede
le 2 Oct. 1910
a l'age de 63 ans. 4 mois.

Marker Stones:
(R13#82)

Epouse
ALBINA
THIBEAULT
30 Mars 1889 - 7 Mai 1955

(R13#84) HELEN DEROCHER
1888 - 1952

(R13#83)

Epoux
ADELARD
THIBEAULT
4 Juin 1883 - 7 Dec. 1966

(R13#85) PETER McMANUS
died
Aug. 4, 1912
Aet. 84 yr's 6 mo's

(R13#86)

JANE McMANUS
wife of
PETER McMANUS
died Nov. 5, 1910.
Aet. 80 yrs. 4 mo's.

(R13#87) MARY T. McMANUS
wife of
HERBERT L. SIMPSON
born Jan. 17, 1865
died Dec. 13, 1958

(R13#88) Guerette / Marquis Monument

East Face:
GUERETTE
North Face:
JOSEPH
GUERETTE
1878 - 1911

West Face:
Ici repose le corps de
ALFRED J. MARQUIS
1885 - 1914
MARQUIS

South Face:
EMILE A.
1910 - 1911
ALFRED H.
1914 - 1915
epouse de
A. J. & E. MARQUIS

(R13#89) Fortin Monument

West Face:
OCTAVE A. FORTIN
1870 - 1945
son epouse
ANGELINE M.
1877 - 1944

East Face:
FORTIN
Qu'ils
reposant
en paix

(R13#91) Gamache Monument

East Face:

Ici repose le corps de
JOSEPH GAMACHE

decede

le 30 Nov. 1910

a l'age de 53 ans

et 7 mois

son epouse

ADELE MORIN

decedee

le 3 Jan. 1933,

a l'age de 77 ans

GAMACHE

North Face:

BLANCHE

HARVEY

epouse de

NAPOLEON

GAMACHE

1899 - 1944

Marker: U.S. Veteran

(R13#96)

Ici repose le corps de

MARC MORREAU

decede le 15, Jan. 1911

a l'age de 49 ans

et 8 mois

(R13#97) Blanchette Monument

South Face:

JOSEPH

BLANCHETTE

1874 - 1938

son epouse

LEDA RIENDEAU

BLANCHETTE

(R13#90) Monaghan Monument

JOHN MONAGHAN

1840 - 1910

MARY MONAGHAN

1832 - 1914

MONAGHAN

Marker Stones:

(R13#92)

NAPOLEON J. GAMACHE

Maine

Pvt Co K 36 Infantry

World War I

Sept 30 1894 Jan 13 1962

(R13#93)

BLANCHE

(R13#94)

JOSEPH GAMACHE

1890 - 1961

(R13#95)

OCTAVE J. GAMACHE

June 21, 1898

Dec. 17, 1956

North Face:

Ici repose le corps de

ULDERIC, enfant de

JOSEPH BLANCHETTE et LEDA RIENDEAU

decede le 6 Juin 1908

a l'age de 4 ans et 10 mois

(R13#98) Bouchard Monument

West Face:

BOUCHARD

East Face:

1912 JEAN M. BOUCHARD 1996
 his wife
 1915 MARY HALL 2004
 his father & mother
 1865 JOSEPH J. BOUCHARD 1926
 1875 LEONTINE TREMBLEY 1965
 their children
 1899 ROSE BOUCHARD 1918
 1908 J. IRENEE BOUCHARD 1908

Marker Stone:

(R13#99) JEAN M BOUCHARD
 S1 US Navy
 World War II
 Jan 22 1912 Feb 27 1996

Marker: U.S. Veteran

(R13#100) Thiboutot Monument

ALFRED THIBOUTOT

1882 - 1943

EXLEA GAMACHE

1882 his wife 1930

their children

1904 ALICE 1911

1911 MORREN 1913

1926 LEONEL 1929

THIBOUTOT

Marker Stones:

(R13#101) ALFRED THOMAS
 JOSEPH THIBOUTOT
 1906 - 1952

(R13#102) RYAN EDWARD BASINET
 June 18, 1986
 Aug. 2, 1986

(R13#103) Hennessey / St. Pierre Monument

East Face:

EDWARD V.

HENNESSEY

1880 - 1962

his wife

CLARA ST. PIERRE

1882 - 1984

HENNESSEY

West Face:

PIERE ST. PIERRE
 decede le 13 Avril 1912
 a l'age de 52 ans
 son epouse
 ADELE LABBE
 decede le 11 Mars 1939
 a l'age de 80 ans
 ST. PIERRE

Marker Stones:

(R13#104) ROBERT G. HENNESSEY
 Oct. 27, 1918
 Nov. 11, 1918

(R13#105) EDWARD

(R13#106) CLARA

(R13#107) MOTHER

(R13#108) NOEL VANDALL
 1843 - 1919

(R13#109) FATHER

(R13#110) Richard Monument

East Face:

ALDERIC RICHARD
1869 - 1944
son epouse
ADELE M. BERNIER
1866 - 1939

West Face:

JOSEPH F. RICHARD
decede
12 Juliette 1894
a l'age de 9 m. 24 j.
Madame
MAGLOIRE BERNIER
decedee
20 Janvier 1908
Priez pour elle

Marker Stones:

(R13#111) ALBERT

(R13#112) PERE

(R13#113) MERE

(R13#115) MERE

(R13#114) MARIE RICHARD
STEDMAN
1901 - 1980

(R13#116) ELISA VANDALL
1843 - 1916

(R13#117) Pere
FRANCOIS MONZEROLL
1869 - 1943

(R13#118) Mere
MARIE C. MONZEROLLE
1878 - 1948

(R13#119) RAOUL
enfant de
FRANCOIS et MARIE MONZEROLL
ne le 11 Avril 1902
decede le 26 Sept. 1908
ange a peine ta vous nous oui
que deja ta nous quitte pour Jesus

(R13#120) Daughter
LILLIAN M. MARSHALL
1896 - 1959

(R13#121) Lavoie Monument

LOUIS M.
LAVOIE

Marker Stones:

(R13#122) Top of stone:
PERE
Face of stone:
1857 - 1939

(R13#123) Top of stone:
MERE
Face of stone:
1853 - 192

(R13#124) Top of stone:
LEONA
Face of stone:
1886 - 1892

(R13#125) Top of stone:
GRAND-MER
Face of stone:
1833 - 1909

Marker Stones Cont'd.:

(R13#126) ST. LAURENT
EMMA M. JOSEPH
1907 - 2007 1907 - 1993

(R13#127) VIRGINIE M. LAVOIE
1885 - 1976

(R13#128) Top of stone:
Ici repose le corps de
Face of stone:
WILFRIET
enfant bien AIMEE de
WELLEY DESROCHER
decede
le 25 Avril 1905.
a l'age de 8 mois et
28 jours.

(R13#129) Top of stone:
Ici repose le corps de
Face of stone:
ALICE
enfant bien AIMEE de
WELLEY DESROCHER
decedee
le 9 Aout 1905
a l'age de 4 ans 6 mois
et 3 jours.

(R13#130) Ici repose le corps de
PERRE FORTIN
decede
le 1 Fevrier 1905
a l'age de 58 ans
ALPHONSE FORTIN
decede
le 25 Decembre 1904
a l'age de 24 ans.
Priez pour lui

(R13#131) JOSEPHINE MAILLOUX
epouse de
1863 DONAT SCHINCK 1943
decede le 13 Juin 1917
a l'age de 51 ans.

(R13#133) FAVREAU
RAYMOND J. GABRIELLE E.
1915 1919 - 1999

(R13#132) Top of stone:
JOSEPH
Face of stone:
fils de
DONAT SCHINCK et
JOSEPHINE MAILLOUX
decede le 7 Oct. 1906
a l'age de 5 ans 11 mois

(R13#135) Caron Monument
CARON

(R13#134) FOURNIER
JOSEPH F. DOLORES C.
1935 - 1939 - 2007

Marker: U.S. Veteran

Marker Stones:
(R13#136) EMILE CARON
1904 - 1907

(R13#137) LIONEL CARON
1907 - 1952

Marker Stones Cont'd.:

(R13#138) JOHN's wife
CECILE CARON
1920 - 2006

(R13#139) JOHN J CARON
US Army
World War II
Jul 1 1916 Aug 8 1987

(R13#140) Pere
ZEPHIRIN CARON
1875 - 1957

(R13#141) Mere
AMANDA CARON
1875 - 1949

(R13#142) Lebel Monument

West Face:

LEBEL

Marker Stones:

(R13#143) ANDRIEN J LEBEL
US Navy
World War II
Jun 18 1916 Mar 24 1994

East Face:

ELZEAR J. LEBEL
8 Fevrier, 1874
30 Octobre, 1944
ses femmes
CLARA M. LANGLOIS
23 Octobre, 1877
13 Mars, 1928
ALMA M. LANGLOIS
1 Fevrier, 1881
30 Janv, 1950

(R13#144) LOUISE Y LEBEL
beloved wife of
ADRIEN J LEBEL
Jan 9 1922 Mar 24 2005

Marker: U.S. Veteran

(R13#145) Coulombe Monument

M. ELISE COULOMBE

Marker Stones:

(R13#146) HENRY G. COULOMBE
1918 - 1982

(R13#147) ADELINE COULOMBE
1883 - 1938

(R13#148) PHIDIME COULOMBE
1879 - 1948

(R13#149) Dion Monument

PHILIAS DION
1848 - 1911
SOPHRONIE MATHURIN
son epouse
1851 - 1927
DION

(R13#150) Cloutier Monument

CLOUTIER
ROLANDE E. CLAIRE E.
Dec. 21, 1917 May 26, 1916
Nov. 10, 1998 Dec. 10, 2001

Marker: U.S. Veteran

(R13#151) ALFRED J LABONTE
Tec5 US Army
Feb 26 1920 Aug 6 1975

(R13#152) AURELIE MARQUIS
Feb. 6, 1882 - Nov. 13, 1961
wife of
HERMENEGILDE LABONTE

(R13#153) Vermette Monument
VERMETTE

Marker: U.S. Veteran

Marker Stones:

(R13#154) LUDGER J. VERMETTE
Maine
Sgt. 1 Cl. Med. Dept.
February 11, 1942

(R13#155) ALBINA
1868 - 1918

(R13#156) CHARLES
1860 - 1936

(R13#157) FRANK
1858 - 1935

(R13#158) JOSEPH - Per
1825 - 1912

(R13#159) Roy / Paradis Monument
East Face:

ROY
-
PARADIS

West Face:

1866 ALFRED ROY 1947
1861 REBECCA his wife 1913
1853 MALVINA his wife 1940
1894 MARY RINGROSE 1940
1890 FLORIAN J. PARADIS 1958
1892 ABBIE C. his wife 195
1928 ROBERT J. PARADIS 195

(R13#160) Gagne Monument
MARIEANNE ARTHUR J.
1887 - 1967 1888 - 1965
GAGNE

Marker Stones:

(R13#161) Ici repose le corps de
EMMA H. GAGNE
decedee le 31, Mar. 1913,
a'lage de 21 ans et 11 mois.

(R13#162) GRACE M. GAGNE
June 25, 1911
Holy
Mary
Pray for m

(R13#163) 1880 ALBERT MORIN 1948
son epouse
1883 DULCINA MORIN 1952

(R13#164) Richard Monument

RICHARD

Marker Stones:

(R13#165) REMI
RICHARD
1871 - 1913

(R13#166) ALPHONSINE
RICHARD
1875 - 1922

(R13#167) ELSIE M.
RICHARD
1894 - 1968

(R13#168) JOSEPH R.
RICHARD
1902 - 1971

(R13#169) Cloutier Monument

North Face:

CLOUTIER
Jesus Marie Joseph

South Face:

1850 JOSEPH CLOUTIER 1938
son epouse
1847 ELISE DEVIN 1913
1883 ANTOINE CLOUTIER 1976
son epouse
1888 M. LOUISE CLOUTIER 1966
1914 IRENEE CLOUTIER 1965
1916 GERTRUDE CLOUTIER

(R13#170) Ici repose le corps de
ALFRED CARON
decede
le 15 Juillet 1919
a'lage de 52 ans.

(R13#171) RUDOLPH E. "RUDY" CARON
June 10, 1928 - Feb. 3, 2001

(R13#172) Marshall Monument

M
DUEL MARSHALL
1844 - 1915
AGNES his wife

Marker Stone:
(R13#173) DUEL

MARSHALL

ST. JOHN THE BAPTIST CEMETERY - Range Layout

RANGE #14

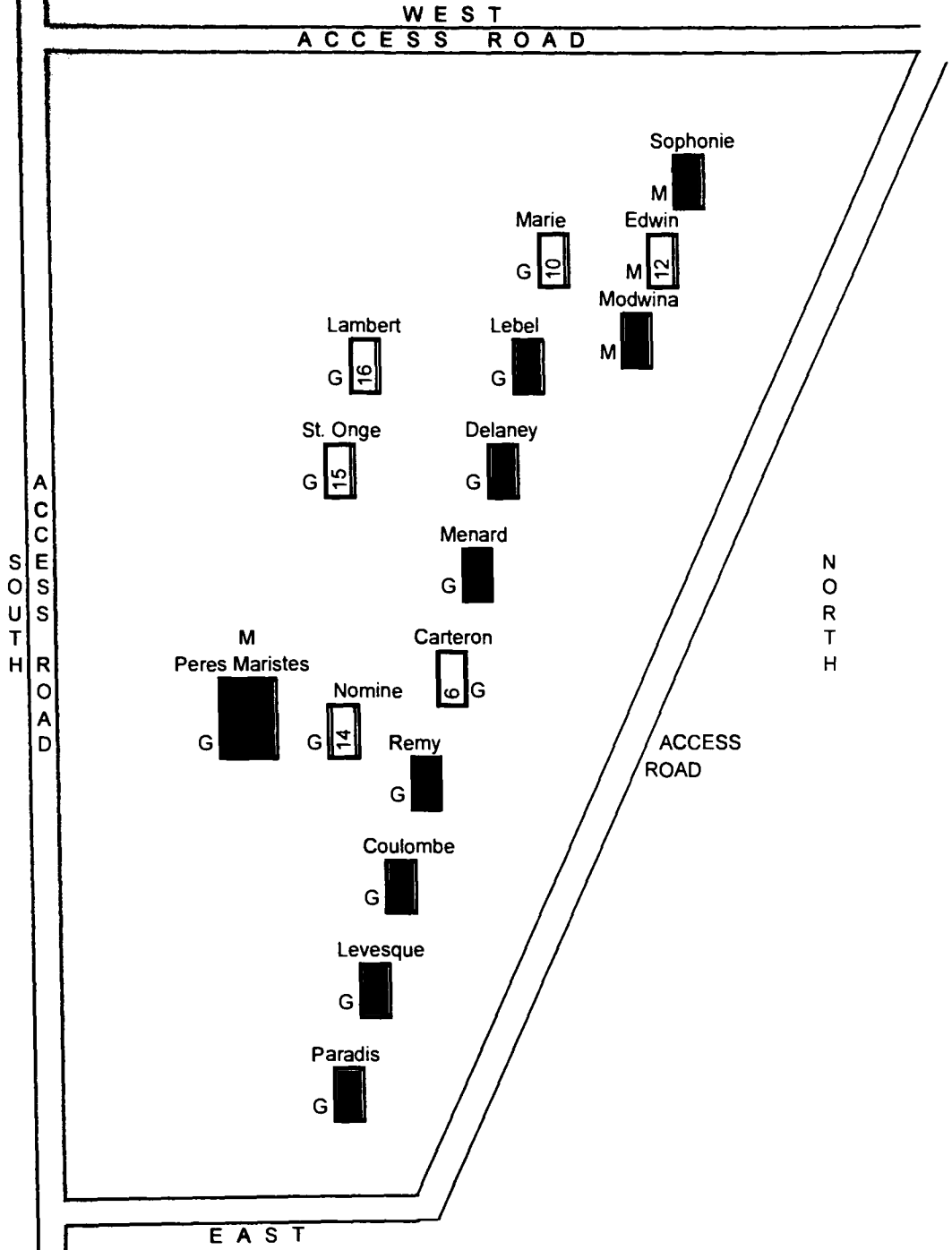

RANGE #14

(R14#1)

M
PERES MARISTES

(R14#2) Brother ADOLPHE PARADIS, S.M.
born November 29, 1908
professed September 12, 1930
died January 24, 1994

(R14#3) Bro. BENOIT LEVESQUE, S.M.
born May 19, 1909
professed in the Society of Mary
September 21, 1933
died March 10, 1984

(R14#4) Bro. OLIVIER LEO COULOMBE, S.M.
born April 11, 1899
professed May 13, 1972
died February 8, 1982

(R14#5) Rev. Pere THEOPHILE J. REMY, S.M.
25 Mai 1855
21 Aout 1926
R. I. P.

(R14#6) R. P. CLAUDE M. CARTERON S.M. Cure
5 Avril 1895
6 Mars 1952
R. I. P.

(R14#7) Rev. Pere GERARD MENARD, S.M.
27 Mars 1903
26 Janvier 1960
R. I. P.

(R14#8) Rev. HERMAN J. DELANEY
born September 10, 1907
ordained June 15, 1935
died February 18, 1987

(R14#9) Rev. DAVID I. LEBEL, S.M.
born September 18, 1913
professed September 8, 1935
ordained February 24, 1942
died August 5, 1987

(R14#10) In sion firmata sum
S. MARIE SOPHONIE de sion
S. MARIE MODWINA de sion
S. MARIE EDWIN de sion

Marker Stones:

(R14#11)

SR
MODWINA

(R14#12)

SR
EDWIN

(R14#13)

SR
SOPHONIE

(R14#14) North Face:

STE. MARIAE NOMINE
1836 - 1986
Marist Laity
Third Order of Mary

South Face:

Let them always bear in mind
that they belong
by a gracious choice
to the Family of Blessed Mary
Mother of God
from whose name they are called
Marists.

Let them constantly try to breathe
Mary's spirit, a spirit
of humility,
self-denial,
close union with God,
and the most ardent love
for their neighbor.

Venerable Father JEAN CLAUDE COLIN, S.M.

(R14#15) Rev. OMER JOHN PAUL ST.ONGE

born August 24, 1920
professed September 15, 1939
ordained February 2, 1946
died November 10, 2007

(R14#16) Rev. JAMES H. LAMBERT, S.M.

born August 29, 1913
professed September 12, 1931
ordained March 27, 1937
died June 1, 1992

ST. JOHN THE BAPTIST CEMETERY - Range Layout

RANGE #15

Map #1

W E S T

A
C
C
E
S
S
R
O
A
D

N
O
R
T
H

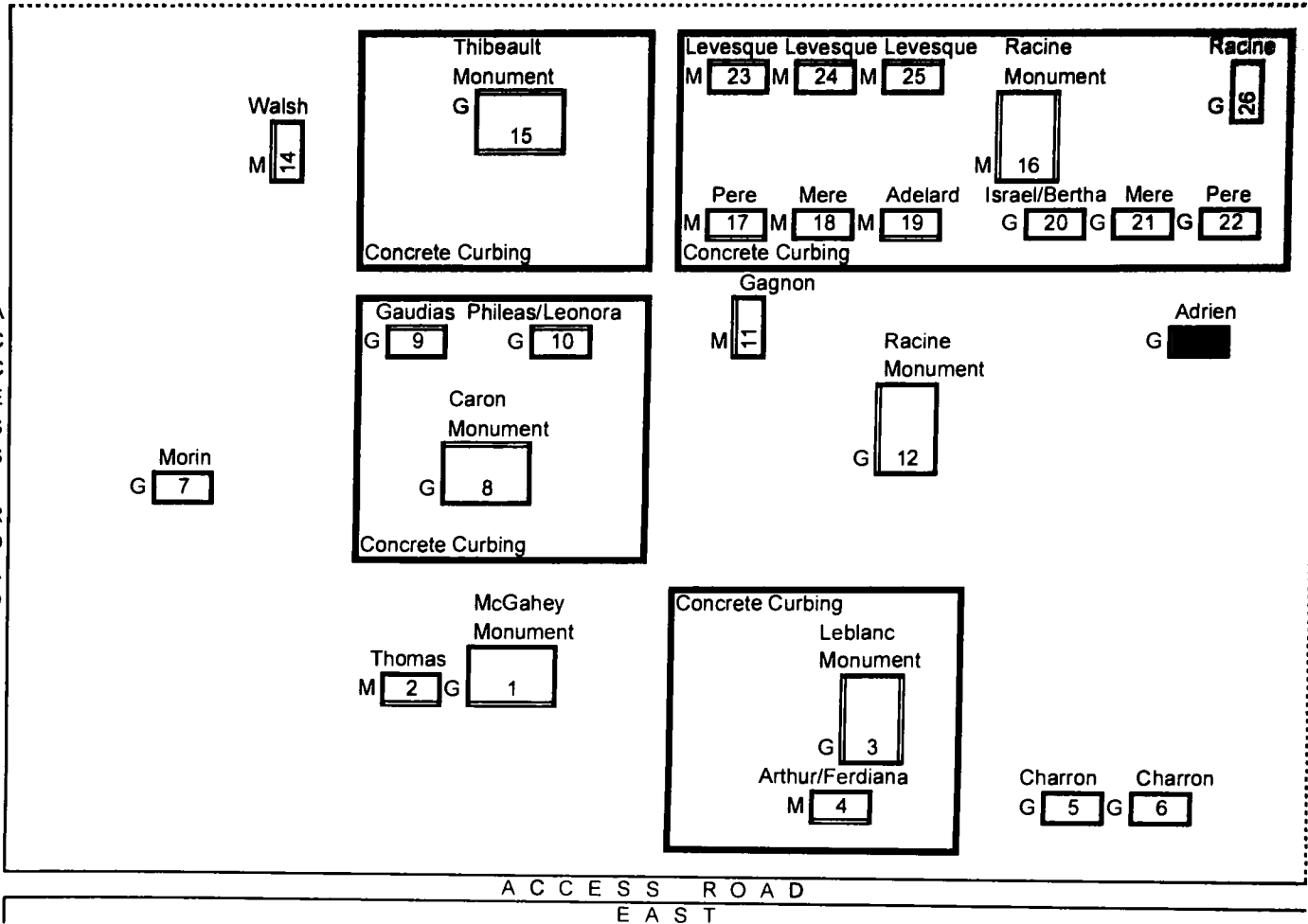

ST. JOHN THE BAPTIST CEMETERY - Range Layout

RANGE #15

Map #1

WEST

ACCESS ROAD

NORTH

ACCESS ROAD

EAST

Walsh







Thibeault Monument

G  15

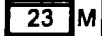

Concrete Curbing

Levesque Levesque Levesque Racine Racine



M  23 M  24 M  25 Monument G 

M  16

Pere Mere Adelard

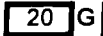

M  17 M  18 M  19

Israel/Bertha Mere Pere

G  20 G  G 

Concrete Curbing

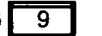
Gaudias Phileas/Leonora

G  9 G  10

Caron Monument

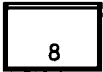
G  8

Concrete Curbing

Gagnon

M  -

Racine Monument

G  12

Adrien

G 

Morin

G 

McGahey Monument

Thomas

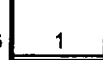
M  2 G  1

Concrete Curbing



Leblanc Monument

G  3

Arthur/Ferdiana

M  4

Charron Charron

G  5 G  6

ST. JOHN THE BAPTIST CEMETERY - Range Layout

RANGE #15
Map #2

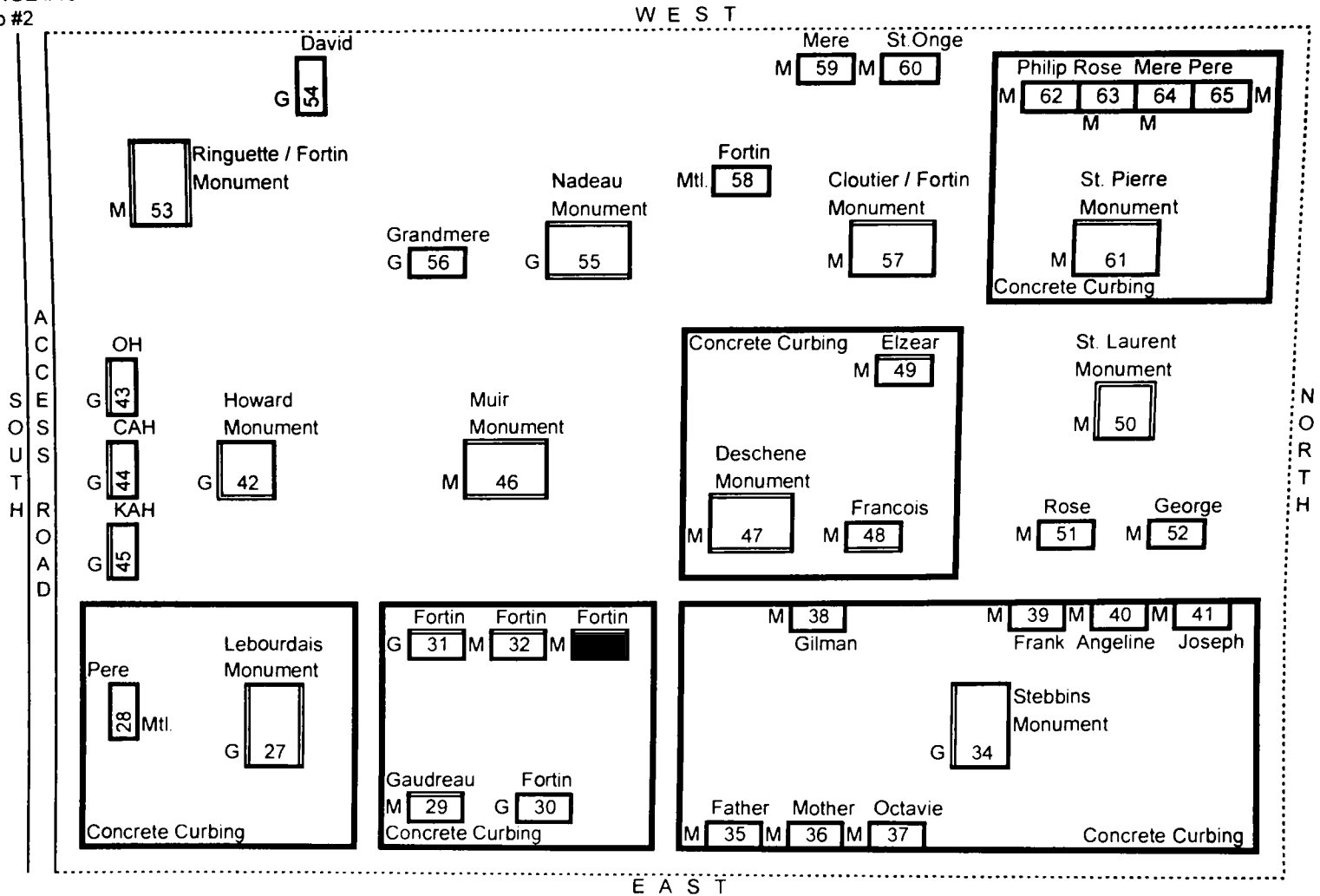

ST. JOHN THE BAPTIST CEMETERY - Range Layout

RANGE #15
Map #3

WEST
ACCESS ROAD

ACCESS
ROAD

NORTH

EAST

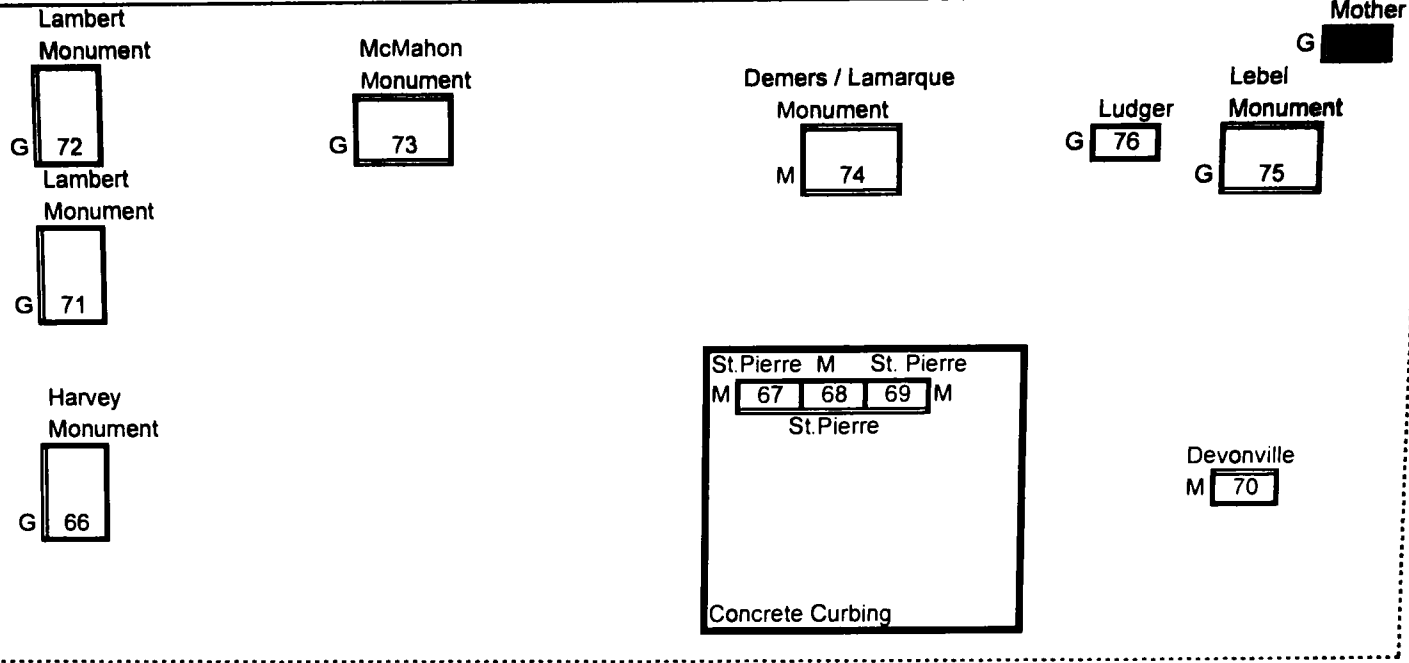

ST. JOHN THE BAPTIST CEMETERY - Range Layout

RANGE #15
Map #4

W E S T

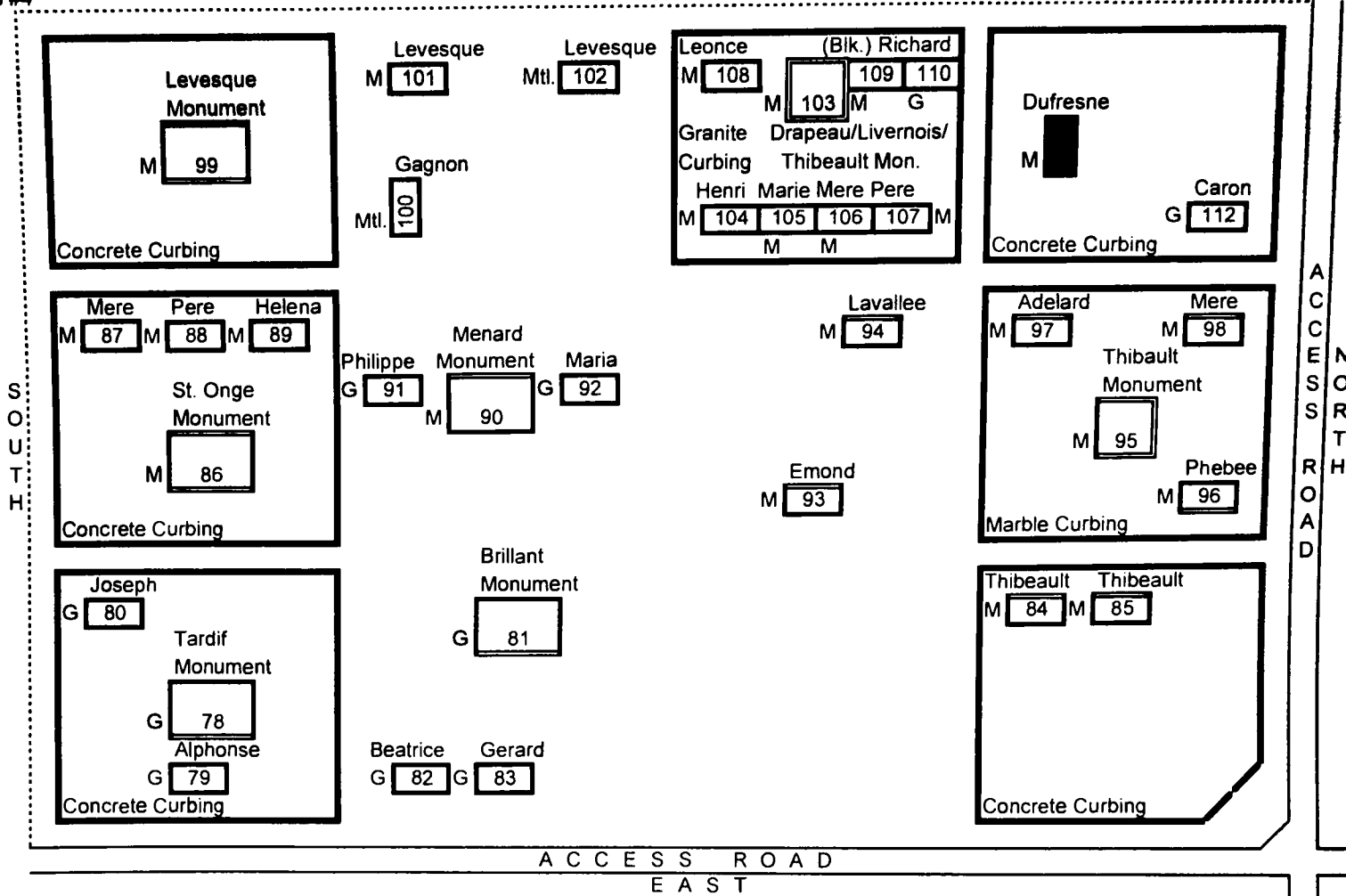

ST. JOHN THE BAPTIST CEMETERY - Range Layout

RANGE #15

Map #5

W E S T

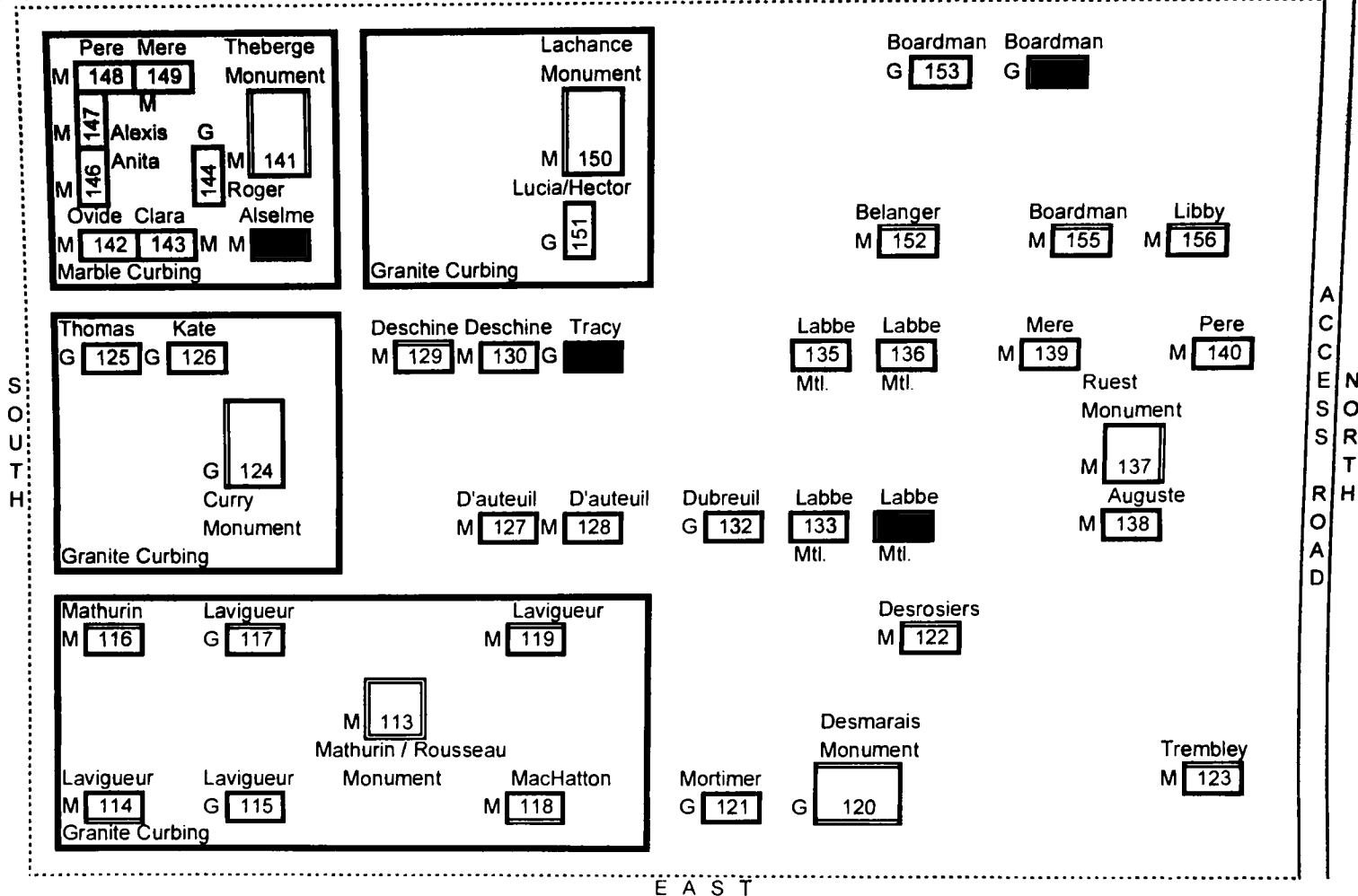

E A S T

A
C
C
E
S
S
R
O
A
D

ST. JOHN THE BAPTIST CEMETERY - Range Layout

RANGE #15
Map #6

WEST
ACCESS ROAD

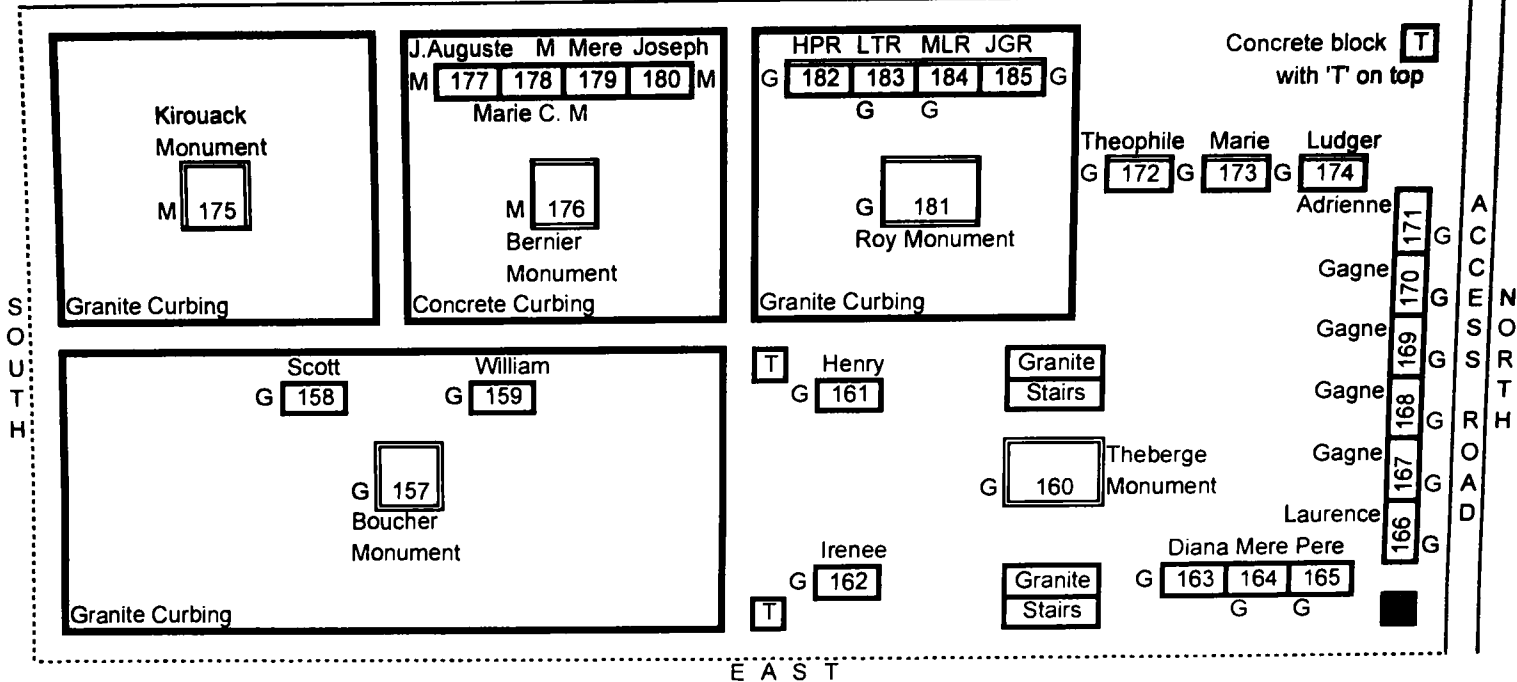

RANGE #15

(R15#1) McGahey Monument

McGAHEY
 HENRY BERNARD May 31, 1924
 Jan. 1, 1852 ANNIE O'LEARY his wife Feb. 16, 1941
 Oct. 2, 1893 THOMAS J. their son Jan. 26, 1912

Marker Stone:
 (R15#2) THOS. J. McGAHEY
 1893 - 1912

(R15#3) Leblanc Monument

South Face:

PHIDIME LEBLANC
 1866 - 1930
 son epouse
 ROSE ANNA LARCHER
 1860 - 1958
 SADIE LEBLANC
 1891 - 1918
 LEBLANC

North Face:

enfants
 1897 EUGENE 1897
 1896 LOUIS 1900
 1894 MARIE A. MESSIER 1960

Marker Stone:

(R15#4)

Ici repose
 ARTHUR A.
 decede
 22 Avril en 1905,
 a'lage 5 ans. et 9 mois

Ici repose
 FERDIANA L.
 decede
 26 Aout. en 1901,
 a'lage 8 mois

enfants EDOURDIANA LEMIRE et AMEDEE LEBLANC

(R15#5) YVONNE CHARRON
 1897 - 1980

(R15#6) WILFRED CHARRON
 1896 - 1984

(15#8) Caron Monument
 AUGUSTE L. CARON
 ne le 4 Fevrier 1851
 decede le 18 Aout 1886

(R15#7) RUSSELL G. MORIN
 Nov. 16, 1922
 May 16, 1923

Marker Stones:

(R15#9) GAUDIAS CARON
 1871 - 1941
 epoux de
 VIRGINIE OUELLETTE
 1872 - 1964

(R15#10) CARON
 PHILEAS LEONORA
 1879 - 1951 1882 - 1974

(R15#11) **JOSEPH
ARTHUR
EMILE
GAGNON**

(R15#12) Racine Monument
South Face:

RACINE
Hail Mary, full of grace

North Face:

Oct. 10, 1900 **WILFRED E. RACINE** May 31, 195
his wife

Oct. 27, 1901 **IRENE FLUET** Oct. 21, 199

(R15#14) **JAMES P. WALSH**
1814 - 1898

Marker: Post 22 G.A.R.

Marker Stone:

(R15#13)

ADRIEN J. RACINE
Maine
Pvt. 233 Station Hosp.
World War II
Jan. 8, 1904 March 26, 1947

(R15#15) Thibeault Monument

East Face:

In loving memory of
THIBEAULT

West Face:

1873 **OCTAVE J.** 19
1871 **AZILDA M.** 1942
1903 **LORENZO** 1906
1899 **ALCIDE** 1899

(R15#16) Racine Monument

South Face:

R
PHILIBERT RACINE
Avril 20, 1845 - Juillet 3, 1900
PHILOMENE son epouse
Aout 12, 1837 - Fevrier 26, 1923
RACINE

North Face:

ISRAEL RACINE
1876 - 1933
ANNIE son epouse
1878 - 1960

Marker Stones:

(R15#17) Top of stone:

PERE

Face of stone:

Member of 1st Vt. Bat.

(R15#20) **ISRAEL T. BERTHA L.**
1913 - 1915 - 1980
RACINE

(R15#23) **MARIE LEVESQUE**
1874 - 1956

(R15#25) **CAMILLE LEVESQUE**
1904 - 1980

(R15#18) **MERE**

(R15#19) **ADELARD RACINE D.D.S.**
Mai 2, 1882
Avril 7, 1928

(R15#21) **MERE**

(R15#22) **PERE**

(R15#24) **HELEN F. LEVESQUE**
1901 - 1969

Marker Stones Cont'd.:

(R15#26)

**RUSSELL A.
1911 - 1978**

**REBECCA Y.
1911 -**

RACINE

In loving memory

(R15#27) Lebourdais Monument

South Face:

EDMOND LEBOURDAIS

1853 - 1941

son epouse

HELENE BOUCHARD

1858 - 1942

LEBOURDAIS

North Face:

Leurs enfants

JOSEPH 1882 - 1882

YVONNE 1896 - 1900

ZOE M. 1878 - 1968

NOE 1887 - 1969

HELENE E. 1890 - 1978

Marker Stone:

(R15#28) PERE

(R15#30)

FORTIN

OVILA Sr. ARTHELINE

1882 - 1953 1879 - 1952

(R15#29) MARIE R. D. GAUDREAU

epouse de

AUGUST FORTIN

decedee le 19 Mai 1920

a'lage de 66 ans

(R15#31)

FORTIN

OVILA L. Jr. ISABELLE

husband wife

1907 - 1983 1906 - 1994

(R15#32) Ici repose le corps de

ERNEST FORTIN

decede

le 18 Fev. 1905

a'lage de 15 ans.

R.I.P.

(R15#33)

LEVI CHARON

son epouse

ZEPHERINE M. FORTIN

1885 - 1921

(R15#34) Stebbins Monument

GEORGE W. STEBBINS

Aug. 20, 1850 - Apr. 23, 1925

AZIELDA M. his wife

Jan. 6, 1854 - May 10, 1927

STEBBINS

Marker Stones:

(R15#35) FATHER

(R15#36) MOTHER

(R15#37) OCTAVIE

Marker Stones Cont'd.:

(R15#38) EMMA S.
GILMAN
1884 - 1923

(R15#39) FRANK G.
STEBBINS
1885 - 1964

(R15#40) ANGELINE D.
STEBBINS
1882 - 1963

(R15#41) JOSEPH
DESCHENES
1883 - 1946

(R15#42) Howard Monument

South Face:

OWEN HOWARD
died
Dec. 21, 1885,
aged 51 yrs.
Thou art gone but not
forgotten.
CATHERINE A.
his wife
died Feb. 13, 1898,
aged 59 yrs.
HOWARD

East Face:

KATIE A.
dau. of
O. & C. A. HOWARD
died Oct. 7, 1875,
aged 14 yrs. 3 mos.

Marker Stones:

(R15#43) O. H.

(R15#44) C. A. H.

(R15#45) K. A. H.

(R15#46) Muir Monument

East Face:

MUIR
CHARLES E. MUIR
1859 - 1899
MARY J. his wife
1857 - 1938

West Face:

Their children
1885 - GENEVIEVE - 1915
1889 - ROBERT E. - 1909
1897 - HELEN A. - 1922

(R15#47) Deschene Monument

West Face:

D
THEOPHILE DESCHENE
1857 - 1899
son epouse
FLORINE PELLETIER
1853 - 1923
JOSEPH E.
1881 - 1901
EMILE
1882 - 1915
DESCHENE

East Face:

ELZEAR DESCHENE
1895 - 1918
PHILIAS
1888 - 1939
ROSANNA
1889 - 1942
AMANDA
1881 - 1954

**Marker Stones:
(R15#48)**

Ici
repose le corps de
FRANCOIS DECHENE
epoux de
LEOPOLDINE PELLETIER
et de ALPHONSENE CARON
nee St. Hubert P.Q. le 8 Fev. 1855
decede a Brunswick le 27 Nov.
1907.
R.I.P.

(R15#49)

ELZEAR
DESCHENES
-
Maine
-
Pvt. 39 Inf. 4 Div.
November 8, 1918

Marker: U.S. Veter:

(R15#50) St. Laurent Monument

West Face:

Ici repose le corps de
THOMAS
ST. LAURENT
decede
le 18. Dec. 1905
agee de 55 ans.
Priez pour lui.
ST. LAURENT

South Face:

FLAVIE
ST. LAURENT
decedee
le 27, Sept. 1924
agee de 64 ans.
Priez pour elle.

North Face:

Ici repose le corps de
THEOPHILE
CLOUTIER
decede
le 10, Jan. 1899
agee de 40 ans
Priez pour lui.

Marker Stones:

(R15#51)

ROSE his wife
1889 - 1934

(R15#52)

GEORGE A. FORTIN
1888 - 1947

(R15#53) Ringuette / Fortin Monument
South Face:

I.H.S.
FORTIN
LOUIS P. FORTIN
1905 - 1971
MELODIA P. son épouse
1906 - 1961

Marker Stone:

(R15#54) DAVID J. FORTIN
July 19, 1944
October 16, 1993

North Face:

PIERRE RINGUETTE
1826 - 1908
son épouse
MERANCE FOURNIER
1834 - 1908
ELZEAR 1877 - 1896
VICTORIA 1871 - 1905
JULES 1874 - 1916
JOSEPH 1867 - 1881
GEORGIANNA 1870 - 1922
épouse de MEVILLE LIHOUX
RINGUETTE

(R15#55) Nadeau Monument

West Face:

NADEAU

East Face:

JOSEPH J. NADEAU
June 30, 1881 Sept. 12, 1954
AMANDA his wife
June 11, 1880 Sept. 8, 1947

Marker Stone:

(R15#56)

Grandmere DUBREUIL
and INFANT SON
1891 - 1918

(R15#57) Cloutier / Fortin Monument

ZEPHIRINE CLOUTIER
1876 - 1960
LAURETTA T. FORTIN
1914 - 1982
CHRISTIAN T. FORTIN
1914 - 1993

Marker: U.S. Veteran

Marker Stones:

(R15#58)

CHRISTIAN T FORTIN
S Sgt US Army Air Corps
World War II
Jul 23 1914 Nov 12 1993

(R15#59)

MERE

(R15#60)

A. ST. ONGE

(R15#61) St. Pierre Monument

S
THEODORE ST. PIERRE
1848 - 1933
CLAUDIA son épouse
1857 - 1941
JOSEPH 1883 - 1919
YVONNE 1898 - 1898
PHILIP 1881 - 1958
ROSE 1886 - 1985
ST. PIERRE

Marker Stones:

(R15#62)

PHILIP

(R15#63)

ROSE

(R15#64)

MERE

(R15#65)

PERE

(R15#66) Harvey Monument
HARVEY

(R15#67) Ci-Git
JOSEPHINE PAQUET
epouse de
AUGUSTE ST. PIERRE
nee en 1858 decedee en 1914
R. I. P.

(R15#70) MARIE ANNE
1908 - 1933
DEVONVILLE

(R15#71) Lambert Monument
LAMBERT
PIERRE D.
Dec. 6, 1921 - Feb. 14, 2003
ELIZABETH his wife
Nov. 8, 1920

(R15#73) McMahan Monument
West Face:
McMAHON
East Face:
JAMES H. McMAHON
1859 - 1921
MARY E. his wife
1859 - 1920
their children
1890 MARGARET 1890
1895 EDWARD 1895

(R15#68) Ici repose le corps de
AUGUSTE ST. PIERRE
epouse de
JOSEPHINE PAQUET.
decede le 26, Mai 1909
a l'age de 47 ans. et 6 mois
Priez pour lui.

(R15#69) Ici
repose le corps de
EMELIE LEVASSEUR
epouse de
THOMAS ST. PIERRE
decedee
le 6 Mai. 1898
a l'age de 63 ans

(R15#72) Lambert Monument
I.H.S.
HENRI LAMBERT M.D.
1881 - 1931
EVELINE D. LAMBERT
1885 - 1973

(R15#74) Demers / Lamarque Monument
West Face:
IHS
HENRY J. DEMERS
1855 - 1931
son epouse
MATHILDE LEVESQUE
1855 - 1933
HONORA leurs fille
1877 - 1949
DEMERS
East Face:
WILLIAM A. LAMARQUE
1879 - 1946
son epouse
LUMINA DEMERS
1881 - 1974
LAMARQUE

(R15#75) Lebel Monument

West Face:

JOSEPH O. LEBEL

1857 - 1920

DINA son epouse

1864 - 1950

OCTAVE LEBEL

1829 - 1911

HERMINE son epouse

1830 - 1924

LEBEL

East Face:

ISRAEL LEBEL

1895 - 1913

Marker Stones:

(R15#76)

LUDGER H. LEBEL

1888 - 1964

(R15#77)

Mother

ALVINE LEBEL

1893 - 1957

(R15#78) Tardif Monument

CLEMENTINE TARDIF

1843 - 1920

MARY TARDIF

1867 - 1901

GEORGIANA TARDIF

1881 - 1907

PHILIPPE TARDIF

1874 - 1915

ARTHUR TARDIF

1881 - 1916

Marker Stones:

(R15#79)

ALPHONSE TARDIFF

1886 - 1969

son epouse

AMANDA LEBEL

1890 - 1968

(R15#80)

JOSEPH TARDIFF

1871 - 1935

(R15#81) Brillant Monument

BRILLANT

Marker Stones:

(R15#82)

BEATRICE BRILLANT

Apr. 26, 1929

Oct. 21, 1982

(R15#84)

**Ici repose le corps de
FEDIME THIBEAULT**

epoux de

ADELE GOSSELIN

decede

le 28 Juillet, 1916

a l'age 45 ans. 2 mois.

(R15#83)

GERARD L. BRILLANT

Oct. 9, 1930

(R15#85)

**Ici repose le corps de
ADELE GOSSELIN**

epouse de

FEDIME THIBEAULT

decede

le 2 Avril 1925

a l'age 51 ans. 9 mois.

(R15#86) St. Onge Monument

East Face:

HELENA M. ST. ONGE
1882 - 1900

West Face:

IHS
TELESPHORE J. ST. ONGE
1849 - 1929
CLAUDIA L. son epouse
1854 - 1931
ST. ONGE

Marker Stones:

(R15#87)

MERE

(R15#88)

PERE

(R15#89)

HELENA M.

(R15#90) Menard Monument

En memoire de
AMANDA MORIN
epouse de
PHILIPPE MENARD
decedee
le 15 Avril 1901.
agee de 28 ans. 4 mos. 12 js.
Priez pour elle.

Marker Stones:

(R15#91)

PHILIPPE MENARD
Dec. 21, 1874 - Sept. 12, 1955
his wife
ROSALIE ST. PIERRE
Feb. 9, 1883 - Jan. 22, 1957

(R15#92)

MARIA E. MENARD
June 27, 1922 - July 27, 2001
her sister
LAURIANNE MENARD
June 25, 1915 -

(R15#93)

Ici
reposant les corps de
LOUIS EMOND
decede Aout 20, 1890,
age de 68 ans 6 mois
et
MARIE M. EMOND
decede Aout 25, 1977,
age de 14 ans 1 mois.
Priez pour eux

(R15#94)

HERMINIGILD,
ne et decede
le 24 Aout. 1889
fil de P. H. LAVALLEE.

HENRIE,
decede le 12 Fevrier 1889
age de 2 ans. et 10 mois.

(R15#95) Thibault Monument

West Face:

Memoire
Ici repose le corps de
ADELARD THIBAUT
epoux de
CLODIA BRASSARD
decedee a Brunswick, Me.
la 26 Mars. 1906
a l'age de 31 ans
2 mois et 26 jours
Priez pour lui

Marker Stones:

- (R15#96) PHEBEE
- (R15#97) ADELARD
- (R15#98) MERE

East Face:

En memoire
de
PHEBEE THIBAUT
1858 - 1918

North Face:

Memoire
Ici repose le corps de
ANNEE POITRAS
epouse de feu
FABIEN THIBAUT
decedee a Brunswick, Me.
le 12 Mars 1900,
a l'age de 61 ans et
5 mois
Priez pour elle
THIBAUT

(R15#99) Levesque Monument

East Face:

MERE PERE
1851 PIERRE LEVESQUE 1925
son epouse
1864 MARIE BILODEAU 1901
LEVESQUE

West Face:

son epouse
1850 LISA SAUCIER 1925
son epouse
1858 MARIE ANNE PAGE 1895
1895 OCTAVE LEVESQUE 1965
1896 RITA son epouse 1965

(R15#100) **ALEXANDRIENNE GAGNON**
1865 - 1942

(R15#101) **NAPOLEON**
LEVESQUE
1880 - 1958

(R15#102) **LUCY LABBEE**
1874 - 1935

(R15#103) Drapeau / Livernois / Thibeault Monument

East Face:

Ici repose le corps de
ZEPHYRE DRAPEAU
epoux de
ANNA MICHAUD
decede le 17 de Decembre
1934
age de 69 ans et 6 mois
ANNA
1868 - 1955
DRAPEAU

West Face:

HENRI R.
1904 - 1986
M. CLAIRE
1916 - 1998
LIVERNOIS

South Face:

Ici repose le corps de
DAVID THIBEAULT
fils epoux de
ANNA MICHAUD
decede le 13 de Septembre 1903
age de 43 ans et 8 mois.
THIBEAULT

Marker Stones:

(R15#104) **HENRI**

(R15#106) **MERE**

(R15#108) **LEONCE**

(R15#110) **RICARD F DILLMAN**
CPO US Navy
Korea Vietnam
Feb 3 1929 Jul 1 2001

North Face:

Ici repose le corps de
JOSEPH D. THIBEAU
decede le 7 Aout 1890
age de 8 mois.

-
AUGUSTE THIBEAULT
decede le 9 Mai 1897
age de 5 1/2 mois.

-
LEONCE THIBEAULT
decede le 13 Aout 1895
age de 8 mois

-
MARIANA THIBEAULT
decede le 3 Aout 1900
age de 7 1/2 mois

Marker: U.S. Veterans

(R15#105) **MARIE**

(R15#107) **PERE**

(R15#109) **(Blank)**

(R15#111)

EMELIA HARVEY
1876 - 1911
epouse de
J. P. DUFRESNE
JOSEPH P. DUFRESNE
1874 - 1935

(R15#112)

CARON
JOSEPH W. DELIM
1900 - 1973 1902 - 1973

(R15#113) Mathurin / Rousseau Monument

South Face:

Ici repose le corps de
FRANCOIS X. MATHURIN
ne 27 Dec. 1863
decede 26 Aout 1927
son epouse
MARIE I. ROUSSEAU
1862 - 1947

West Face:

Ici repose le corps de
HONORE G. ROUSSEAU
decede
le 18 Aout, 1899,
a l'age de 67 ans et 10 mo
Parents et
ROUSSEAU

North Face:

Ici repose le corps de
FRANCOIS X. MATHURIN
decede
le 3 Juin 1883
a l'age de 3 mois et 19 jours
et
JOSEPH H. MATHURIN
decede
le 3 Janvier 1900
a l'age de 10 mois et 26 jours.

East Face:

Ici repose le corps de
LAURA E. COFFIN
epouse de
IRENEE MATHURIN
1886 - 1908
MATHURIN

Marker Stones:

(R15#114) LAVIGUEUR
1926 GEORGE G. Jr. 1939
1897 ROSA C. 1965
1896 GEORGE G. 1967

(R15#115) GEORGE G LAVIGUEUR
Maine
Pvt US Army
World War I
Feb 22 1894 Dec 25 1967

(R15#116) ANSEL E. MATHURIN
1904 - 1944
JOSEPHINE E. MATHURIN
1904 - 1997

(R15#117) LAVIGUEUR
FRANCOIS IRENEE
Jan. 5, 1928 Dec. 25, 2007

(R15#118) MacHATTON
1887 GEORGE A. 1924
1889 MARIE ANNE 1947

(R15#119) LAVIGUEUR
1930 JEAN LOUIS 1985

(R15#120) Desmarais Monument

East Face:

MARTIN DESMARAIS
1943 -
BARBARA BERNIER
DESMARAIS
1954 -

West Face:

ELZEARD DESROSIERS
1873 - 1945
ALPHONSINE PLOURDE
DESMARAIS
1878 - 1948
MARIE DESROSIERS
DESMARAIS
1907 - 1995

Marker Stones:

(R15#121) CECILE M. MORTIMER
1910 - 2007

(R15#122) GONZAGUE
DESROSIERS
1911 - 1935

(R15#123) HANTONIO TREMBLEY
died
Aug. 15, 1893
Ae. 5 mos.

(R15#124) Curry Monument

C
THOMAS CURRY
died July 10, 1919
Ae. 75 ys.
KATHERINE, wife of
THOMAS CURRY,
died Apr. 26, 1908
Ae. 75 ys.
CURRY

Marker Stones:

(R15#125) THOMAS

(R15#126) KATE

(R15#127) FERNANDE LAVOIE
D'AUTEUIL
1927 - 1999

(R15#128) LUCIEN D'AUTEUIL
1920 - 1980

(R15#129) Top of stone:

ANITA DESCHINE

Face of stone:

(R15#130) MARIA M. DESCHENE
1890 - 1949

epouse de
JAMES TRACEY
decedee
le 26 Oct. 1918
a l'age de 34 ans. 8 mois.

(R15#131) EDWARD JAMES TRACY
Mar. 12, 1917 - Aug. 27, 1995
ANITA DIONNE TRACY
July 8, 1919

(R15#133) LEONCE LABBE
1869 - 1944

(R15#132) LUDGER D DUBREUIL
PFC US Army
World War II
Feb 9 1927 Jun 25 1984

(R15#134) DELIMA LABBE
1869 - 1942

(R15#135) **JOSEPHINE LABBE**
1888 - 1952

(R15#136) **EUGENE LABBE**
1893 - 1970

(R15#137) **Ruest Monument**

OCTAVE RUEST
decede le 15 de Mar 1904
age de 73 ans
JOSEPHINE HARTON
son epouse
decedee le 21 de Nov. 1899
agee de 77 ans.
AUGUSTE RUEST
decede le 16 de Feb. 1903
age de 13 ans.
RUEST

Marker Stones:
(R15#138) **AUGUSTE**
(R15#139) **MERE**
(R15#140) **PERE**

(R15#141) **Theberge Monument**

South Face:

ALX. THEBERGE **ESTHER COUILLARD**
decede le 7 Mai. 1907 **DESPRES**
a l'age de 66 ans decedee le 30 Oct. 1921
et 2 mois a l'age de 75 ans
et 2 mois

epoux et epouse
THEBERGE

North Face:

ALSELME THEBERGE
decede le 24 Juillet 1903
a l'age de 24 ans et 3 mois
OVIDE L. THEBERGE
1880 - 1944
son epouse
CLARA FORTIN
1879 - 1944

Marker: U.S. Veteran

Marker Stones:

(R15#142)	OVIDE	(R15#143)	CLARA
(R15#144)	ROGER WILLIAM THEBERGE Oct. 8, 1950 - Mar. 31, 1999	(R15#145)	ALSELME
(R15#147)	ALEXIS J THEBERGE T Sgt US Army World War II Oct 20 1916 Sep 8 1994	(R15#146)	ANITA M PAQUETTE beloved wife of ALEXIS J THEBERGE Jan 19 1920 June 28 2004
	(R15#149)	(R15#148)	PERE
			MERE

(R15#150) **Lachance Monument**

L
JOSEPH LACHANCE
1865 - 1945
ses epouses
ALPHONSINE TARDIF
1864 - 1914
JOSEPHINE PAQUETTE
1869 - 1948
NAPOLEON 1887 - 1899
EVA 1888 - 1918
EMILLE 1889 - 1890
LIDIA 1897 - 1897
LACHANCE

Marker Stone:

(R15#151) **LUCIA M.** **HECTOR A.**
1895 Mother 1961 1894 Father 1961

(R15#152) Top of stone:

MARIE BLANCHE

Face of stone:

enfant de
ANNA et JEAN B. BELANGER
decede
le 11 Nov. 1899
agee 2 ans. 9 mois 19 jours

(R15#153) **ALICE M. BOARDMAN**
1914 - 1990

(R15#154) **EARLE H. BOARDMAN**
1898 - 1970

(R15#155) **ANNIE E. DUBREUIL**
1887 - 1945
wife of **EARL H. BOARDMAN**

(R15#156) **HATTIE HART LIBBY**
May 31, 1855
October 13, 1909

Well mightest thou have heard when san
life's setting sun
thy savious words in heaven: "welcome.
well done."

(R15#157) **Boucher Monument**

East Face:

Ici repose les corps de
JOSEPH ALEXIS PARFAIT
age de 2 mois 8 jours
decede le 6 Mai 1885
MARIE DELIA
age de 3 ans et 9 mois
9 jours
decede le 7 Decembre 1887
JOSEPH PHILIPPE GEORGE
age de 15 ans et 2 mois
14 jours
decede le 5 Janvier 1905

North Face:

DAMASE BOUCHER
1850 - 1932
GEORGIANA A.
epouse de
DAMASE BOUCHER
1856 - 1921
HENRI J. BOUCHER
1892 - 1944
ALBERT L. BOUCHER
1893 - 1945

Marker: U.S. Veteran

(R15#157 Boucher Monument Cont'd.)

South Face:

WILLIAM BOUCHER
1876 - 1940
BERTHA son epouse
1872 - 1949
BLANCH YVONNE
1898 - 1913
GERTRUDE GODIN
1901 - 1978

West Face:

B
1903 **LEON** 1971
wife
1906 **YVONNE** 2004
son
1929 **WILLIAM** 2000
grandson
SCOTT FIELD
1961 - 2005
BOUCHER

Marker Stones:

(R15#158) **SCOTT FIELD**
BOUCHER
June 28, 1961
Sept. 6, 2005

(R15#159) **WILLIAM J BOUCHER**
Cpl US Army
Korea
Nov 9 1929 Aug 27 2000

(R15#160) Theberge Monument

East Face:

A la memoire de
JOSEPH THEBERGE
epoux de
MATHILDE COUILLARD
decede le 4 Avril 1900
age de 64 ans et 11 mois
Priez pour lui
J. THEBERGE

North Face:

Memoire
Ici repose
le corps de
DIANA THEBERGE
decede a Brunswick
Maine. le 8 Mai a
l'age de 34 ans. en
l'annee 1899
THEOPHILE

West Face:

Memoire
Ici repose
le corps de
MATHILDE COUILLARD
epouse de
JOSEPH THEBERGE
decede a Hallowell, Me.
le 20, Nov. 1898
a l'age de 68 et 2 mois
Priez pour elle
J. THEBERGE

South Face:

IRENEE

Marker Stones:

(R15#161)

THEBERGE
1909 **HENRY E. THEBERGE** 1973
husband of
MARY T. MOSKO

(R15#162)

IRENEE
1873 - 1937

(R15#163)

DIANA

Marker Stones Cont'd.:

(R15#164)

MERE

(R15#165)

PERE

(R15#166)

LAURENCE THEBERGE
Oct. 2, 1910 - Nov. 26, 1980
wife of
CAMILLE GAGNE

(R15#167)

EUGENE H. GAGNE
Oct. 17, 1942 -
son of
CAMILLE & LAURENCE

(R15#168)

RICHARD L. GAGNE
Oct. 22, 1943 - Jan. 27, 2008
son of
CAMILLE & LAURENCE

(R15#169)

OMER E. GAGNE
Dec. 21, 1949 -
son of
CAMILLE & LAURENCE

(R15#170)

CAMILLE F. GAGNE
Nov. 13, 1905 - May 10, 1987
husband of
LAURENCE THEBERGE

(R15#171)

ADRIENNE THEBERGE
Feb. 6, 1907
Apr. 23, 1977

(R15#172)

THEOPHILE (R15#173)
THEBERGE
1872 - 1956

MARIE L. (R15#174)
THEBERGE
1875 - 1933

LUDGER J. (R15#174)
THEBERGE
1905 - 1954

(R15#175) Kirouack Monument

West Face:

Ici repose
DELIMA CARON
epouse de
MAXIME KIROUACK
decede
le 4 Sept. 1897
a l'age de 33 ans 11 mois
R.I.P.
KIROUACK

South Face:

Ici repose
ALCIDE KIROUACK
decede
le 8 Aout 1893
age de 2 mois

North Face:

FRANCOIS C.
BOUCHER
1895 -
his wife
DELIA K.
1889 - 1959

(R15#176) Bernier Monument

West Face:

**JEAN BAPTISTE
AUGUSTE
BERNIER
1872 - 1949
MARIE C.
his wife
1874 -
BERNIER**

East Face:

**Ici
repose les corps de
MARIE LYDIA BERNIER
ne le 19 Novembre 1896
decedee le 27 Aout 1897
et de
MARIE GEORGIENNE
BERNIER
ne le 19 Novembre 1896
decedee le 3 Janvier 1898**

Marker Stones:

(R15#177) J. AUGUSTE

(R15#178) MARIE C.

(R15#179) MERE

(R15#180) JOSEPH MICHAUD

(R15#181) Roy Monument

West Face:

**J. GEDEON ROY
1867 - 1951
son epouse
LEONTINE THEBERGE
1862 - 1921
HEDWIDGE POULIN son epouse
1869 - 1934
ROY**

East Face:

**ANTONY J. ROY
1904**

Marker Stones:

(R15#182) H. P. R.

(R15#183) L. T. R.

(R15#184) M. L. R.

(R15#185) J. G. R.

ST. JOHN THE BAPTIST CEMETERY - Range Layout

RANGE #16
Map #1

W E S T

A
C
C
E
S
S
R
O
A
D

N
O
R
T
H

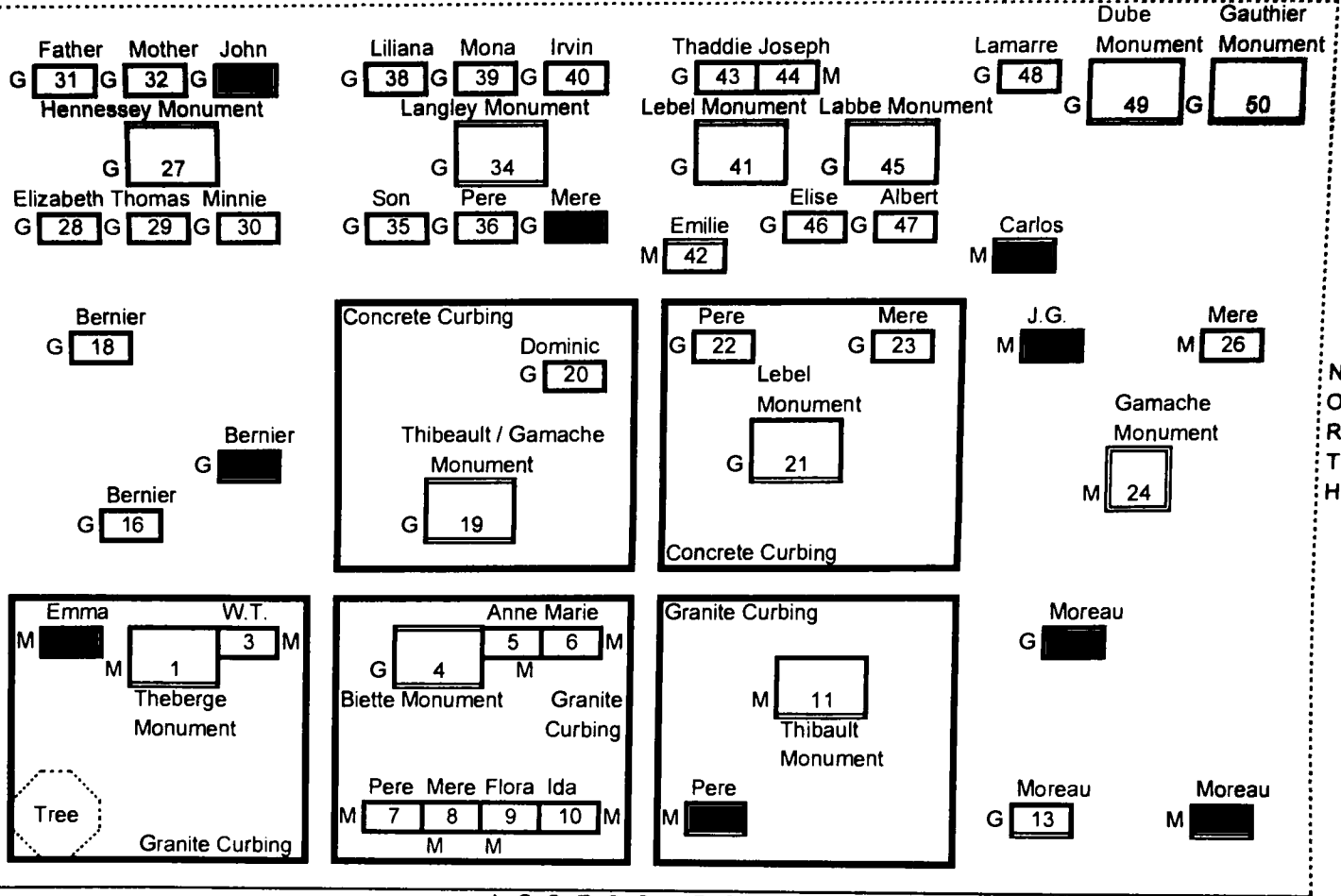

A C C E S S R O A D

E A S T

ST. JOHN THE BAPTIST CEMETERY - Range Layout

RANGE #16
Map #2

W E S T

A
C
C
E
S
S
R
O
A
D

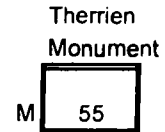
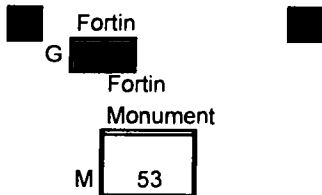
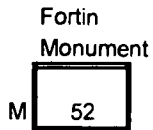
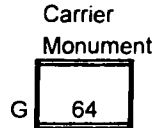
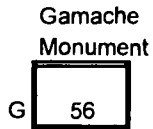
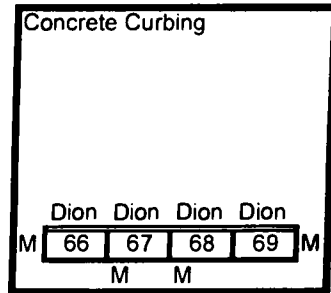
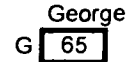
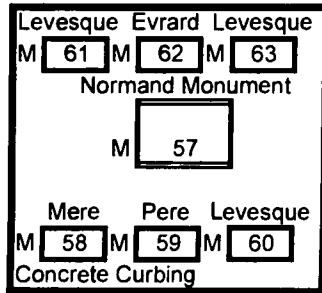
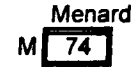
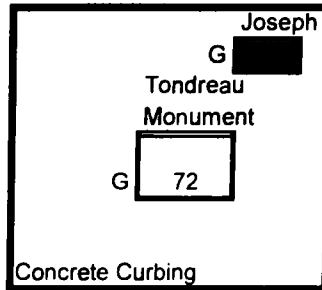
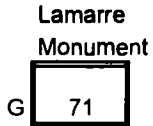
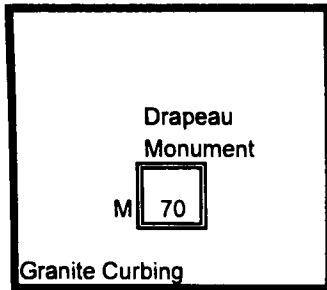

Granite Block
[Redacted] with 'F' on top

N
O
R
T
H

E A S T

ST. JOHN THE BAPTIST CEMETERY - Range Layout

RANGE #16
Map #3

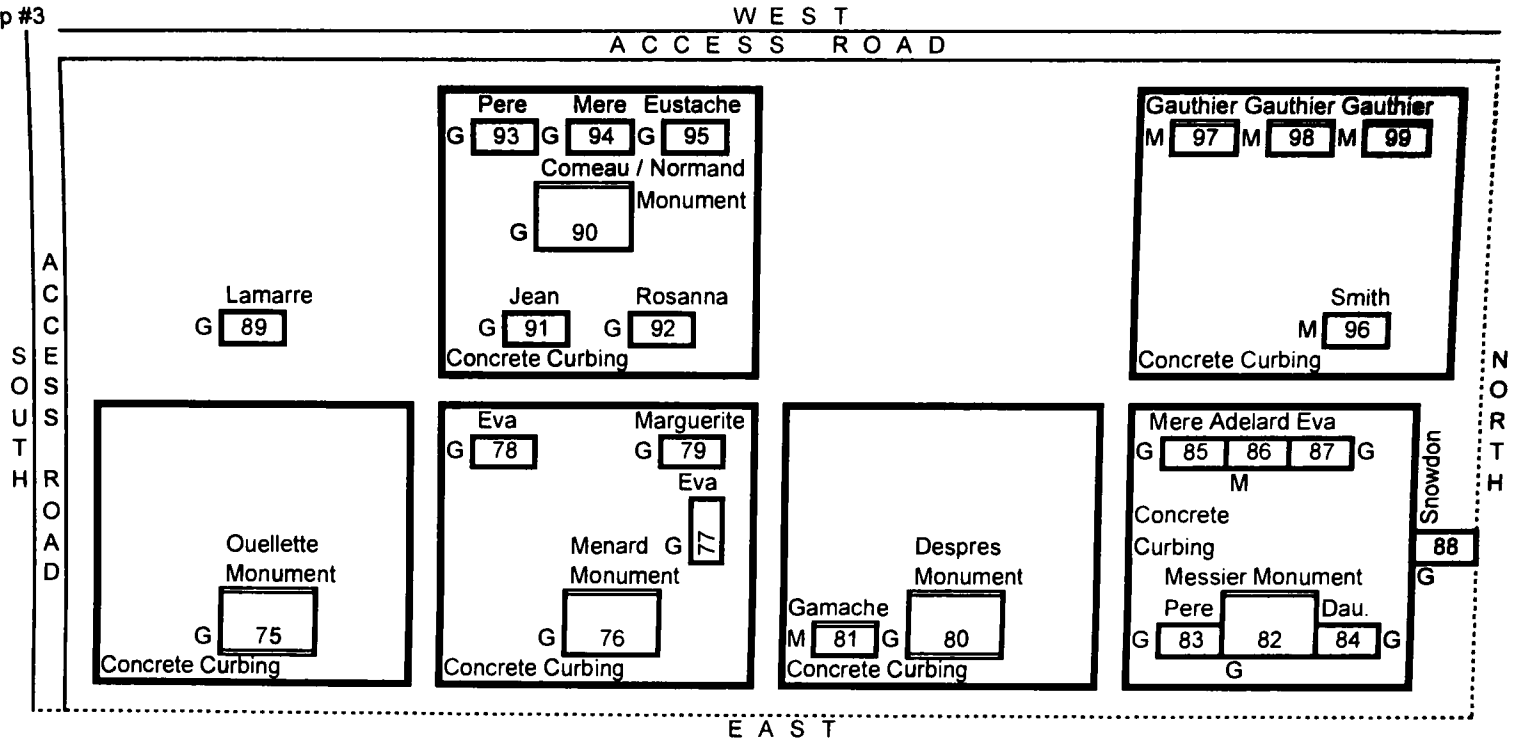

ST. JOHN THE BAPTIST CEMETERY - Range Layout

RANGE #16
Map #4

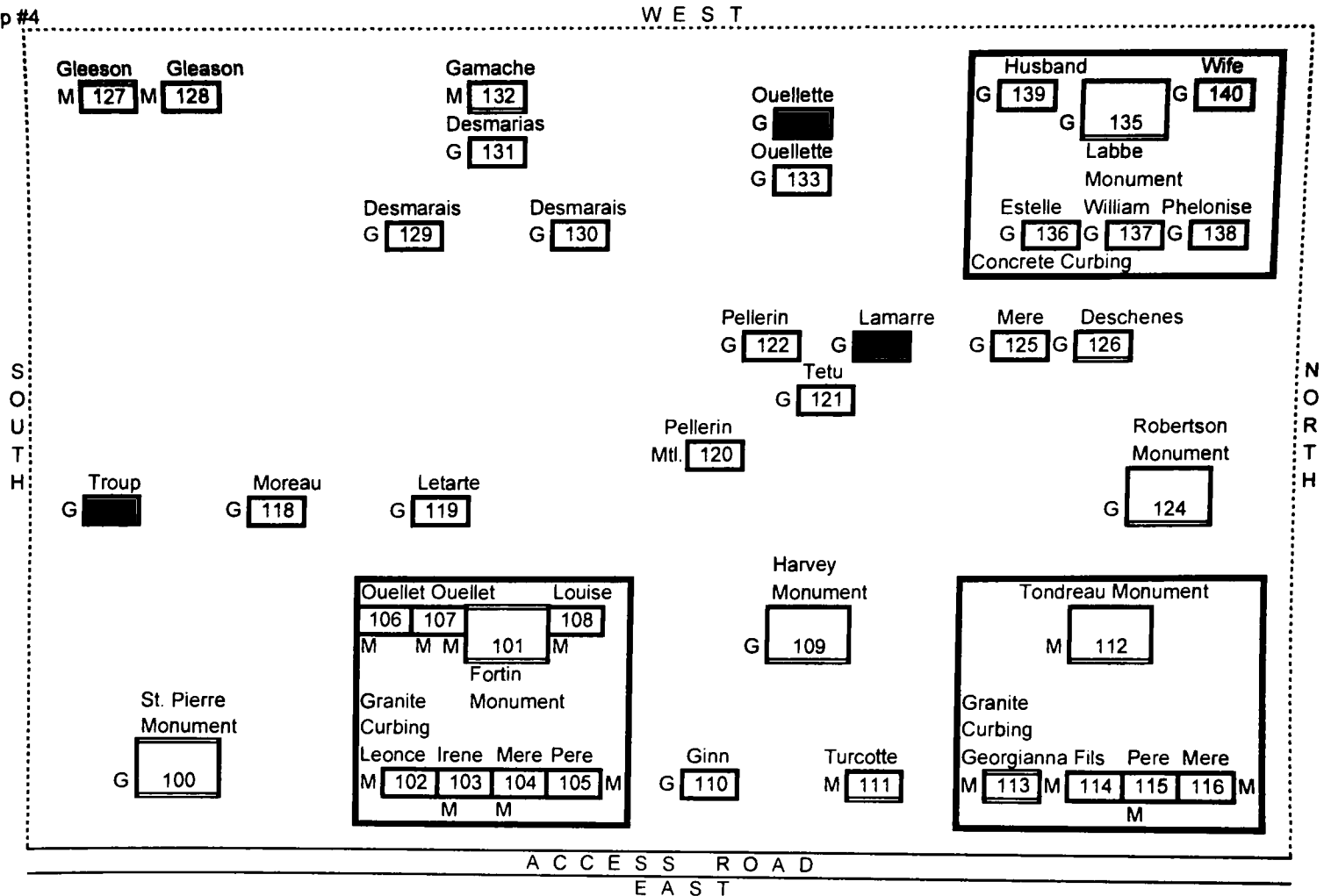

ST. JOHN THE BAPTIST CEMETERY - Range Layout

RANGE #16
Map #5

W E S T

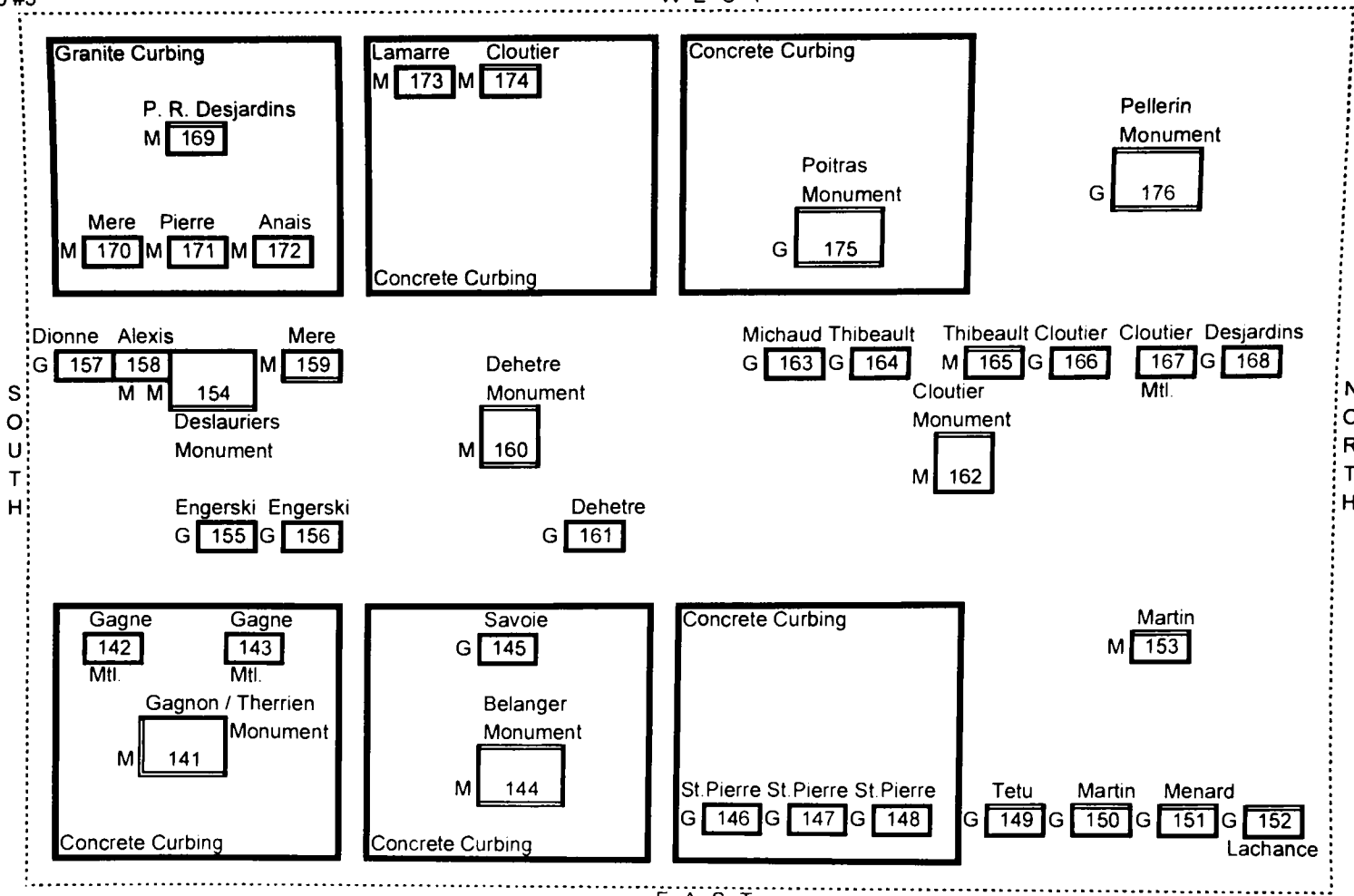

E A S T

ST. JOHN THE BAPTIST CEMETERY - Range Layout

RANGE #16

Map #6

W E S T

A C C E S S R O A D

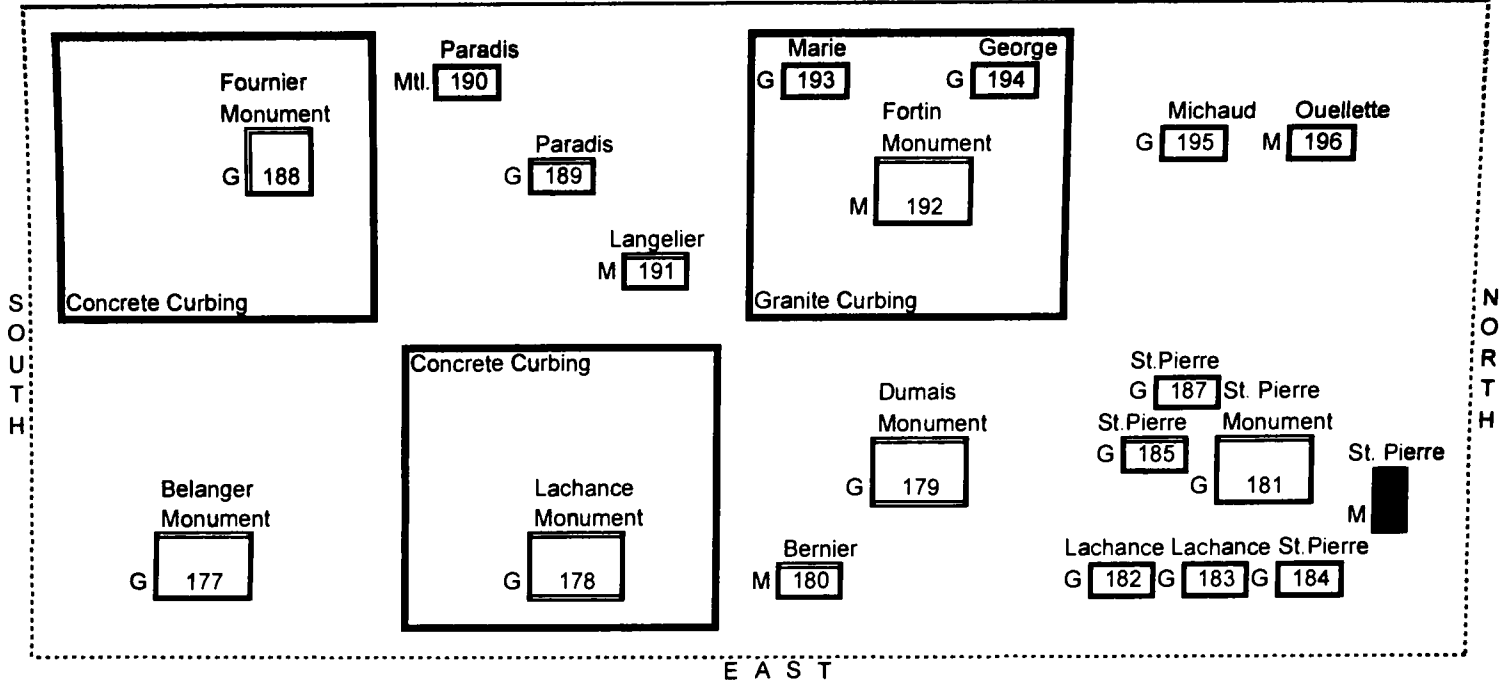

ST. JOHN THE BAPTIST CEMETERY - Range Layout

RANGE #16

Map #7

W E S T

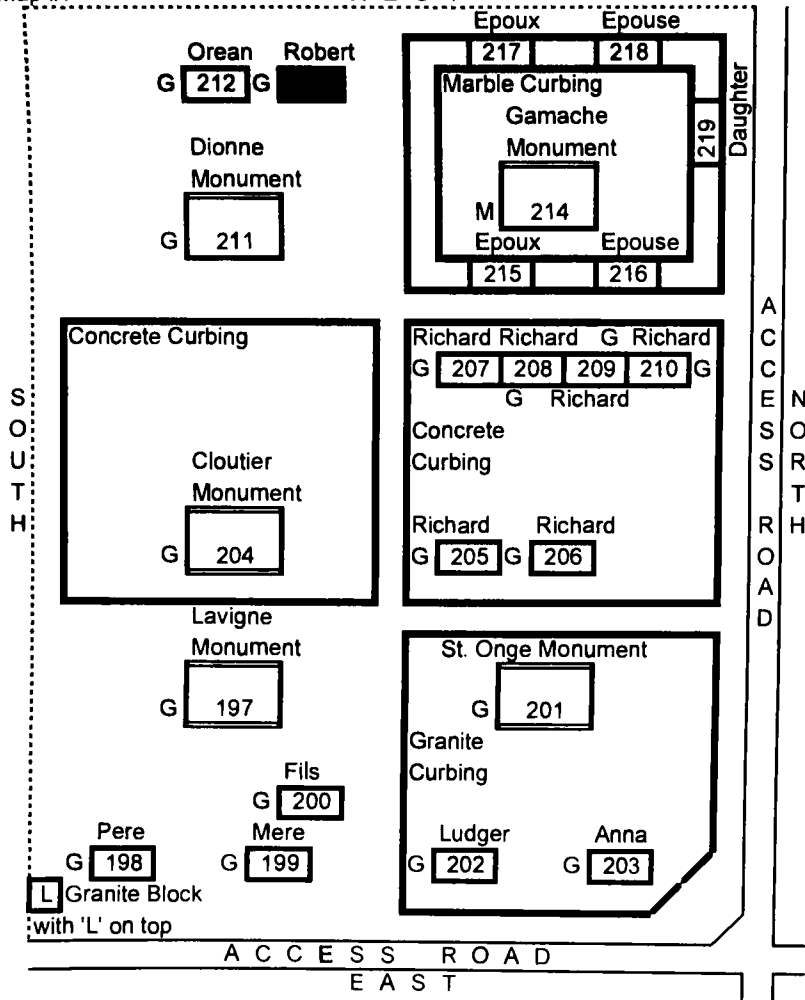

ST. JOHN THE BAPTIST CEMETERY - Range Layout

RANGE #16

Map #8

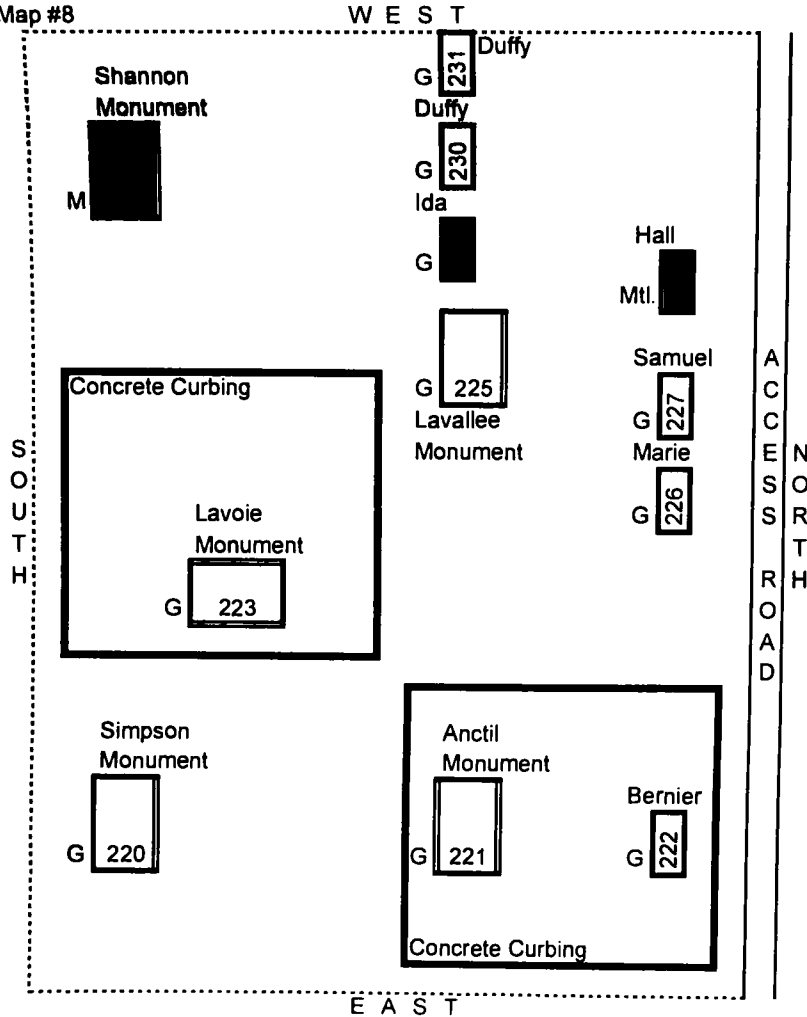

ST. JOHN THE BAPTIST CEMETERY - Range Layout

RANGE #16
Map #9

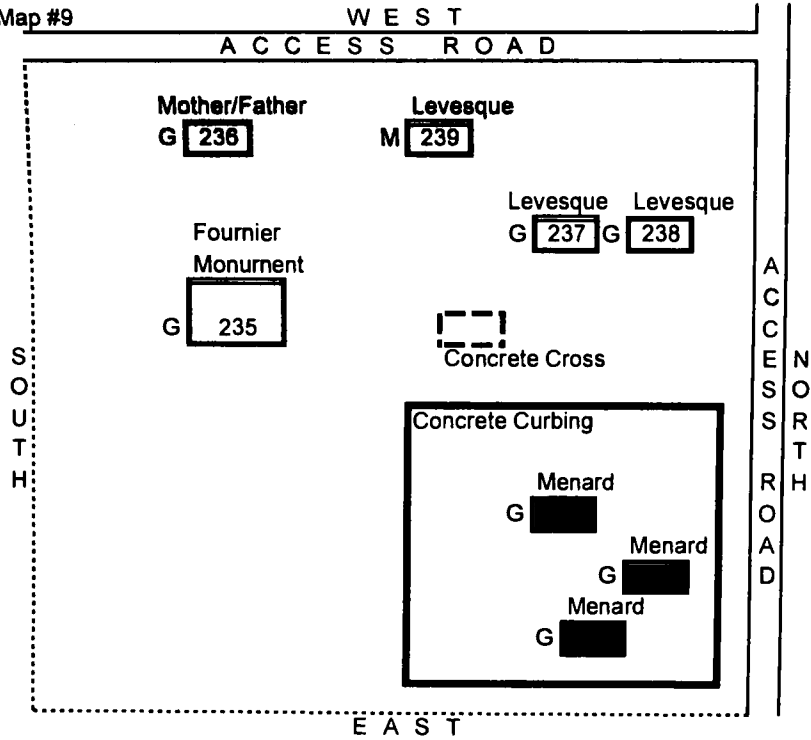

RANGE #16

(R16#1) Theberge Monument
WIFRID THEBERGE
 1868 - 1923
 son epouse
EMMA THIBAUT
 1862 - 1936
THEBERGE

Marker Stones:
 (R16#2) EMMA
 (R16#3) W. T.

(R16#4) Biette Monument
 East Face:

BIETTE

epoux epouse
 LEO J. REGINA F.
 1890 - 1967 1894 - 1979
 Jesus Marie Joseph

1859 MICHEL BIETTE 1938 1888 FLORA 1943
 son epouse 1889 IDA A. 1913
 1861 LOUISE DESJARDINS 1935 1896 MARIE A. 1896

West Face:

1859 MICHEL BIETTE 1938
 son epouse
 1861 LOUISE DESJARDINS 1935

Marker Stones:

(R16#5) ANNE (R16#6) MARIE (R16#7) PERE
 (R16#8) MERE (R16#9) FLORA (R16#10) IDA

(R16#11) Thibault Monument

En memoire de
JOSEPH D. THIBAUT
 epoux de
DOMETILE VERMETTE
 decede a
 Brunswick, Me.
 de 26 Mars 1905,
 a l'age de
 44 ans 7 mois et 12
 jours
 Priez pour lui
THIBAUT

Marker Stone:
 (R16#12) PERE

(R16#13) MOREAU
 WILLIAM DELIA
 1872 - 1944 1872 - 1950

(R16#14) **MARIE EZILIA MOREAU**
decedee
Janvier 8, 1903
age 2 ans.

(R16#15) **PHILIP O. MOREAU**
1903 - 1966
LILLIAN M. MOREAU
1901 - 1982

(R16#16) **C. BERNIER**
1875 - 1933

(R16#17) **LOUIS BERNIER**
Oct. 15, 1869 - May 29, 1933
YVONNE LEVESQUE
July 2, 1899 - Apr. 18, 1978

(R16#18) **ARTHUR L. BERNIER**
Mar. 4, 1904 Oct. 31, 1966
MARIE R. BERNIER
Mar. 11, 1918 Mar. 12, 2005

(R16#19) Thibeault / Gamache Monument
East Face:

Plaque:

If tears could build a
stairway and memories
a lane, I'd walk right up
to heaven and bring
you home again.

THIBEAULT
-
GAMACHE

West Face:

ALPHONSE THIBEAULT
1877 - 1947
DIANA his wife
1871 - 1934
DOMINIC GAMACHE
1921 - 2003
IRENE his wife
1923 -

(R16#21) Lebel Monument
JOSEPH L. LEBEL
1867 - 1929
son epouse
LEA LEDA LEBEL
1869 - 1952

Marker: U.S. Veteran

1903 **CECILE** 1903
1905 **ALBENI** 1905
1906 **SIMONNE** 1906
1898 **ALPHE** 1906
LEBEL

Marker Stone:

(R16#20) **DOMINIC A GAMACHE**
US Army
World War II
1921 2003

Marker Stones:

(R16#22) **PERE**

(R16#23) **MERE**

(R16#24) Gamache Monument

West Face:

G
Ici repose de corps
de
JOSEPH
GAMACHE
decede
le 28 Fevrier 1906 de
31 ans et 11 mois
R. I. P.
GAMACHE

East Face:

ADELARD
CASAVANT
1872 - 1953
his wife
CAROLINE
DIONNE
1879 - 1933

North Face:

Priez pour
dame LUMENA
MILLARD
epouse de feu
JULES DIONNE
decede le 8 Octobre
1905
a l'age de 56 ans
R. I. P.

South Face:

JOSEPH
CAOQUETTE
1880 - 1951

Marker Stones:

(R16#25) J. G.

(R16#26) MERE

(R16#27) Hennessey Monument

HENNESSEY

JOHN 1835 - 1923
MARY R. his wife 1843 - 1911
JOHN Jr. 1863 - 1947
THOMAS F. 1875 - 1951
MINNIE 1866 - 1957
ELIZABETH 1885 - 1967

Marker Stones:

(R16#28) ELIZABETH

(R16#29) THOMAS

(R16#30) MINNIE

(R16#31) FATHER

(R16#32) MOTHER

(R16#33) JOHN

(R16#34) Langley Monument

West Face:

W. LANGLEY

East Face:

WILLIAM 1901 - 1967
ROSE C. wife 1906 - 2001
ROBERT H. LANGLEY 1932 - 1951
IRVIN B. LANGLEY son 1929 - 1988
MONA ELAINE wife 1930 - 1994

Marker Stones:

(R16#35) Son
ROBERT

(R16#36) Pere
WILLIAM

(R16#37) Mere
ROSE

Marker: U.S. Veteran

Marker Stones Cont'd.:

(R16#38) LILIANA LANGLEY
July 18, 1929
June 13, 1986

(R16#39) MONA ELAINE LANGLEY
wife of
IRVIN B LANGLEY
Oct 4 1930 Aug 18 1994

(R16#40) IRVIN B LANGLEY
US Army
Korea
Feb 2 1929 Jul 18 1988

(R16#41) Lebel Monument

LEBEL
MARIANNA THADDIE
1898 - 1992 1893 - 1985
In God's care

Marker: U.S. Veteran

Marker Stones:
(R16#42)

1891
EMILIE CARON
epouse de
JOSEPH LABEE,
agee de 45 ans

(R16#45) Labbe Monument

LABBE
EUGENE J. ELIZABETH D.
1873 - 1955 1874 - 1963

Marker Stones:

(R16#46) ELISE LABBE
1860 - 1943

(R16#47) ALBERT J. LABBE
1894 - 1944

(R16#43) THADDIE LEBEL
Pvt US Army
World War I
Jan 3 1893 Nov 1 1985

(R16#44) Top of stone:

YVONNE

Face of stone:

Decedee
le 18, Jan. 1903
age 5 ans 9 ms 9 js
enfant de
JOSEPH et EUGENE LABBE

(R16#49) Dube Monument

DUBE
CECILE Y. ALBERT W.
1917 - 1999 1915 - 1984

(R16#48) YVETTE B. LAMARRE
Sept. 6, 1918
Feb. 5, 1996

(R16#50) Gauthier Monument

Married Oct. 23, 1954
GAUTHIER
HENRY P. JACQUELINE C
Sept. 26, 1930 July 2, 1935
Sept. 29, 2006

In loving memory

(R16#51) PHILIAS CARLOS
1860 - 1943
son epouse
ELISE MORIN
1863 - 1904
JOSEPHINE MARAIS
epouse de GEO. CARLOS
1897 - 1931

(R16#52) Fortin Monument
JOSEPH FORTIN
decede
le 7 Jan. 1900
age 39 ans. 5 mois
FORTIN

(R16#53) Fortin Monument
AUGUSTE FORTIN Jr.
1877 - 1931
son epouse
ANNA RICHARD
1876 - 1952
FORTIN

Marker Stone:
(R16#54) FORTIN
LUCIENNE PROSPER
1912 - 2004 1911 - 1977
Jesus Mary Joseph

(R16#55) Therrien Monument
MATILDA NADEAU,
epouse de
JOSEPH THERRIEN,
decede le 14 Avril 1903
a l'age de 48 ans et 6 mois
Priez pour elle

(R16#56) Gamache Monument
GAMACHE
ANTONIO R. LILLIAN
1899 - 1974 1903 -

(R16#57) Normand Monument
East Face:
N
OZIAS NORMAND
ne le 8 Jan. 1874
decede le 22 Mar. 1945
son epouse
DIANA MICHAUD
ne le 24 Mai 1870
decedee le 14 Juillet 1914
NORMAND

West Face:
EVRARD
ne le 8 Oct. 1898
decede le 3 Mai 1904
FLORIDA
ne le 12 Jun 1904
decedee le 5 Dec. 1917

Marker Stones:
(R16#58) MERE (R16#59) PERE (R16#60) DENIS J. LEVESQUE
(R16#61) LAURA A. LEVESQUE (R16#63) ROLAND D. LEVESQUE 1906 - 1993
1909 - 1953 1931 - 1942 (R16#62) EVRARD

(R16#64) Carrier Monument

West Face:

CARRIER

East Face:

1874 ALFRED CARRIER 1920
son epouse
1875 VIRGINIE BOUSQUET 1946
1898 GEORGE CARRIER 1954
son epouse
1899 FIDELIA MOREAU

Marker: U.S. Veteran

Marker Stone:

(R16#65)

GEORGE CARRIER

Maine

Pvt 103 Field Artillery

World War I

Jan 19 1898 Sept 14 1959

(R16#66)

Ici repose le corps de
ANNA GAGNON
epouse de
MEDERIQUE DION,
decedee 31 Mar. 1904
a l'age de 25 ans et 2 mois
Priez pour elle

(R16#67)

Ici repose le corps de
ANNIE CRESSEY
epouse de
MEDERIC DION
decedee le 18 Avril 1919
a l'age de 36 ans.
Priez pour elle

(R16#68)

Ici repose le corps de
FRANCOIS DION
decede le 30 Avril 1938
a l'age de 58 ans.
Priez pour lui

(R16#69)

Ici repose le corps de
MARIE D. DESBIENS
epouse de
TELESPHORE DION
decedee le 31 Mar. 1924
a l'age de 75 ans, 9 mois.
Priez pour elle

(R16#70) Drapeau Monument

West Face:

FRANCOIS
DRAPEAU
1861 - 1921
son epouse
JOSEPHINE
de LAMARRE
1863 - 1935
DRAPEAU

South Face:

A la memoire
de toujours regrette
ANNE
1892 - 1899
CONRAD
1898 - 1900
ISOLA
1896 - 1900
enfants bien aimes
de FRANCOIS et
JOSEPHINE DRAPEAU.

(R16#70 Drapeau Monument Cont'd.):

East Face:

YVONNE
1888 - 1956
epouse de
LOUIS H. COTE

North Face:

FRANCOIS O.
DRAPEAU
1906 - 1945
CONRAD L.
DRAPEAU
1901 - 1963

(R16#71) Lamarre Monument

LAMARRE
1893 FLORIAN 1974
1892 MARION 1925
1915 ROLAND J. 1970

(R16#72) Tondreau Monument

LOUIS BARTHELEMY TONDRE
1839 - 1902
FLORE MARIE BETTY
son epouse
1852 - 1919
MARIA A. TONDREAU
1875 - 1930
TONDREAU

(R16#74)

Ici repose le corps de
ISAIE MENARD
epoux de
ADELE FOURNIER
decede
le 2 Mai 1915
a l'age de 50 ans
1 mois 18 jours
Priez pour lui.

Marker Stone:

(R16#73) JOSEPH C
1895 - 1956

(R16#75) Ouellette Monument

West Face:

OUELLETTE

East Face:

1870 JOSEPH OUELLETTE 1957
son epouse
1871 ANNA MORIN 1949
1897 ARCHILLE OUELLETTE
son epouse
1894 GRACIA M. ROUX 1962
1899 LOUISIA LEMAY 1955

(R16#76) Menard Monument

A. MENARD
Ici repose la famille d' AMEDE MENARD
dites un "Je vous salue, Marie"

Marker Stones:

(R16#77) Their daughter
EVA A. MENARD
1896 - 1995

(R16#78) EVA

(R16#79) MARGUERITE
1902 - 1957

(R16#80) Despres Monument

West Face:

DESPRES

Coeus sacre de Jesus, ayez pitie de nous

East Face:

Epouse

CECILE GAMACHE

22 Aout 1903 - 28 Dec. 1973

Epoux

ALBERT C. DESPRES

1 Oct. 1903 - 20 Janv. 1956

Marker Stone:

(R16#81)

PHILOMENE CARON

epouse de

JOHN B. GAMACHE

1873 - 1929

1871 - 1952

(R16#82) Messier Monument

IHS

FRANCIS MESSIER

1866 - 1950

ARTHELINE RACINE son epouse

1873 - 1952

MESSIER

Marker: U.S. Veteran

Marker Stones:

(R16#83)

PERE

(R16#84)

Daughter

JULIETTE E. MESSIER

1908 - 2003

(R16#85)

MERE

(R16#86)

ADELARD A

MESSIER

-

Maine

-

301 Engrs 76 D

May 15 1936

(R16#88)

Daughter

SARAH M. SNOWDON

1914 - 1988

(R16#89)

1892 NAPOLEON LAMARRE 1976

his wife

1901 ROSALDA PAINCHAUD 1967

1891 ROSE LAMARRE 1985

(R16#87)

EVA LEVESQUE

1895 - 1925

epouse de

ADELARD MESSIER

(R16#90) Comeau / Normand Monument

COMEAU

-

NORMAND

Marker Stones:

(R16#91)

JEAN BAPTISTE

NORMAND

1891 - 1911

Marker Stones Cont'd.:

(R16#92)

**ROSANNA
COMEAU
1899 -**

(R16#93)

**Pere
JULES NORMAN
1868 - 1945**

(R16#94)

**Mere
VITALINE NORMAND
1869 - 1956**

(R16#95)

**EUSTACHE
NORMAND
1889 - 1941**

(R16#96)

**MARY SMITH
1892 - 1952**

(R16#97)

**ANDREW GAUTHIER
born Dec. 11, 1860
died Dec. 29, 1937**

(R16#98)

**Faithful unto death
MARIE AGLAE
wife of
ANDREW GAUTHIER
born Sept. 1, 1866
died Dec. 1, 1925**

(R16#99)

**Ici repose le corps de
ELISE GAUTHIER
epouse de JOSEPH CARON
decedee a Brunswick, Me.
le 26, Juin 1903,
a l'age de 26 ans.
Parents et amis priez pour elle**

(R16#100) St. Pierre Monument

East Face:

ST. PIERRE	
JOSEPH EMILE D.	DOSITHEE
1909 - 1997	1873 - 1944
wife	wife
BERNADETTE	PHELONISE
FORTIN	THEBERGE
1907 - 1976	1873 - 1921

West Face:

1844	ARTHUR ST. PIERRE	1911
	wife	
1851	MARIE FORTIN	1911
1874	ULRIC ST. PIERRE	1941

(R16#101) Fortin Monument

East Face:

CHARLES F. FORTIN		
1864 - 1920		
son epouse		
PHILOMENE RINGUETTE		
1869 - 1941		
FORTIN		
1903	ISIDORE OUELLET	1973
son epouse		
1898	MARIE ANNE FORTIN	1974

West Face:

JULE	1893 - 1894
JOSEPH C.	1894 - 1895
CECILE	1904 - 1907
LUCIA	1910 - 1912
MARIE LOUISE	1902 - 1938

Marker Stones:

(R16#102) LEONCE J. FORTIN
1891 - 1920

(R16#103) IRENE L. FORTIN
1896 - 1978

(R16#104) MERE

(R16#105) PERE

(R16#106) ISIDORE
OUELLET
1903 - 1973

(R16#107) MARIE ANNE
OUELLET
1898 - 1974

(R16#108) M. LOUISE

(R16#109) Harvey Monument
HARVEY
THOMAS JULIE
1872 - 1920 1874 - 1950

(R16#110) JEANNETTE H. GINN
March 7, 1903
September 28, 1999

(R16#112) Tondreau Monument
IHS
EMILE TONDREAU
1876 - 1950
son epouse
GEORGIANA PAQUETTE
1877 - 1935
FLORIEN G. fils
1907 - 1990
TONDREAU

(R16#111) ISOLA
TURCOTTE
1906 - 1943

Marker Stones:

(R16#113) East Face:
GEORGIANNA

West Face:
enfant de
EMILE et GEORGIANNA
TONDREAU
decedee le 28, Oct. 1912
a l'age de 11 ans et 5 mois

(R16#117) MADELEINE G. TROUP
Mar. 25, Jan. 12,
1924 1988

(R16#114) FILS
Aug. 3, 1907
Dec. 3, 1990

(R16#118) DELIA G. MOREAU
Oct. 24, Jan. 10,
1889 1969

(R16#115) PERE

(R16#116) MERE

(R16#119)

LETARTE
JOHN B. GEORGIANNA A.
1891 - 1944 1892 - 1986
Jesus Marie Joseph

(R16#120)

LEON J PELLERIN
AS US Army
World War II
Jun 28 1913 Jun 9 1989

(R16#121)

LUCILLE LAMARRE
TETU
1910 - 2003
In God's care

(R16#122)

PELLERIN
LEON "Spark" IRENE
1913 - 1989 1912 - 1994

(R16#123)

LAMARRE
NAPOLEON MARIE LOUISE
1880 - 1958 1883 - 1968

(R16#124) Robertson Monument

ROBERTSON
Mother Son
RITA M. GEORGE J. Jr.
Aug. 8, 1920 Sept. 11, 1943
July 12, 1944 July 11, 1944

(R16#125)

Mere
MARY BAILLARGEON
1883 - 1946

(R16#126)

A. L. DESCHENES
et famille

(R16#127)

CORNELIUS GLEASON
born Dec. 25, 1819
died Apr. 19, 1906

(R16#128)

MARY E. GLEASON
1866 - 1931

(R16#129)

HARRY DESMARAIS
1899 - 1931

(R16#130)

GEORGE C. DESMARAIS
Pvt. Co. H. 151 Depot Bgd.
World War I
1891 - 1955

(R16#131)

DIANA GAMACHE DESMARAIS
1871 - 1951
sa fille
ALICE ROSE DESMARAIS
1896 - 1972

(R16#132)

Ici reposant les corps de
APOLINE GAMACHE
epouse de
FLORENTE GAMACHE
1837 - 1919
et de
sa fille
APOLINE
1863 - 1914
Priez pour elles.

(R16#133)

OUELLETTE
CHARLES A. Jr. MARIE ANNE
1911 - 1974 1911 - 2002
In loving memory

(R16#135) Labbe Monument
A la memoire de
ESTELLE LABBE

Marker Stones:

(R16#136) ESTELLE
LABBE
1860 - 1941

(R16#137) WILLIAM
LABBE
1894 - 1988

(R16#139) Husband
JOSEPH A.
LABBE
1890 - 1974

(R16#134) 1907 SOPHIE F. OUELLETTE 1914
1880 AZELIA LABERGE 1915
1914 LAURENT OUELLETTE 1926
1885 GRAZIELLA OUELLETTE 1950
1879 CHARLES OUELLETTE 1959

(R16#138) PHELONISE
COULOMBE
1850 - 1914

(R16#140) Wife
BERNADETTE O.
LABBE
1901 - 1959

(R16#141) Gagnon / Therrien Monument
South Face:

Families
N. GAGNE
et
J. THERRIEN

Marker : U.S. Veteran

East Face:

LUMINA
THERRIEN
1874 - 1905
JOSEPH
THERRIEN
1878 - 1914

Marker Stones:

(R16#142) JOSEPH N GAGNE
1879 - 1965

(R16#143) ROGER A GAGNE
Tec 4 US Army
World War II
Nov 21 1919 Feb 28 1994

(R16#144) Belanger Monument
West Face:

B
FABIEN BELANGER
1854 - 1932
son epouse
EXILIA NADEAU
1858 - 1945
ALPHONSINE
1886 - 1963
BELANGER

East Face:

1884 EXILIA 1906
1900 JOSEPH A. 1916

Marker Stone:

(R16#145) WILLIAM R. SAVOIE
1886 - 1959
DIANA M. his wife
1896 - 1973

(R16#146) **MARGUERITE M. ST. PIERRE**
June 29, 1919
February 13, 2000

(R16#147) **ARTHUR ST. PIERRE**
died July 12, 1943
ALICE L. ST. PIERRE
died March 26, 1967

(R16#148) **Rev. ARTHUR H. ST. PIERRE**
died March 2, 1995

(R16#149) **TETU**
FORREST L. RACHEL N.
Dec. 8, 1923 July 17, 1925

(R16#150) **MARTIN**
ANASTASIE P. EUSTACHE
died Jan. 3, 1934 died Jan. 21, 1915
at age of 68 yrs. at age of 45 yrs.

(R16#151) **MENARD**
REMI N. ALVINA R.
Dec. 25, 1925 June 7, 1928
Jan. 4, 1987

(R16#152) **MARE ANNE**
LACHANCE
May 25, 1904
Sept. 16, 1979

(R16#153) **EVA MARTIN**
decedee le 5 Fevrier 1920
l'age de 18 ans et 11 mois

(R16#154) **Deslauriers Monument**
1857 **ALEXIS** 1934
son epouse
1859 **AGLEE DESBIEN** 1889
son epouse
1871 **AMANDA MICHAUD**
1868 **LOUIS** 1933
son epouse
1866 **HERMINE COTE** 1929
1877 **MICHELE** 1906
1828 **ELIZABETH** 1908
DESLAURIERS

Marker: U.S. Veteran

Marker Stones:
(R16#155) **EDITH M. ENGERSKI**
his wife
Jan. 2, 1904 Mar. 12, 1980

(R16#156) **JOHN S. ENGERSKI**
Illinois
S2 USNR F
World War I
June 8 1896 Feb 4 1949

(R16#157) **MARJORIE EDITH**
DIONNE
1933 - 1935

(R16#158) **ALEXIS**

(R16#159) **MERE**

(R16#160) Dehetre Monument

West Face:

Ici repose le corps de
CASIMIA DEHETRE
epouse de
ELEONARD POLIQUIN
decede le 21, Fev. 1907
a l'age de 56 ans. 8 mois
Priez pour lui.
son epouse
ELEONORE
POLIQUIN
decedee le 3, Jun. 1926
a l'age de 82 ans. 18 jours
Priez pour elle.
DEHETRE

(R16#162) Cloutier Monument

C

Ici repose le corps de
HIPOLYTE CLOUTIER
epoux de
PHILOMENE PAIMENT
decede
le 16 Fevrier 1916
a l'age de 55 ans
Parent et ami someney vous
de moi dans vos priere
CLOUTIER

Marker: U.S. Veteran

(R16#166)

CLOUTIER
Jesus Marie Joseph
YVONNE FLORIDO
1902 - 1980 1897 - 1939

(R16#168)

Our beloved mother
MARCELLA T. CLOUTIER
December 15, 1928
April 21, 2004
With the love of Jesus in her heart.

East Face:

ALICE DEHETRE
decedee
le 19 Dec 1918
at age de 31 ans 6 jours
Priez pour elle.

Marker Stone:

(R16#161) **DEHETRE**
VICTOR J. EVA PHILIPPON
1890 - 1953 1895 - 1983

(R16#163)

MICHAUD
In loving memory
THOMAS JEANNETTE
1901 - 1983 1909 - 1971

(R16#164)

THIBEAULT
Jesus Marie Joseph
JOSEPH A. ELODIA
1882 - 1954 1886 - 1977

(R16#165)

M. YVONNE
enfant de
JOSEPH THIBEAULT
et de
ELODIA CLOUTIER
decede le 2 Fev. 1913
a l'age de 6 ans et 4 mois
Darling

(R16#167)

ROMEO MAURICE CLOUTIER
Cpl US Army
Korea
Aug 16 1928 May 20 1997

(R16#169) P. R. DESJARDINS

Marker Stones:

(R16#170)

Mere
1826 - 1907

(R16#171)

PIERRE
DESJARDINS
Aug. 24, 1942

(R16#172)

ANAIS
DESJARDINS
Sept. 8, 1943

(R16#173) LEON LAMARRE
1828 - 1916
son epouse
ADELLE
1824 - 1906

(R16#174) AGNESIA ELVINE PAMILA
enfant de
J. H. & POMELA
CLOUTHIER
decede le 15 Aout 1891
age'e de 4 mois.

(R16#175) Poitras Monument

West Face:

POITRAS

East Face:

1861 AUGUSTE POITRAS 1955
son epouse
1870 LUMINAS LACHANCE 1953
et famille

(R16#176) Pellerin Monument

West Face:

Ci - Git
WILFRED J. PELLERIN
decede le 15 Mars 1912
a l'age de 31 ans
ADELAIDE des biens son epouse
1876 - 1955
PELLERIN

East Face:

BARTHELEMIE BOULANGER
1870 - 1944
epouse
MARIE DESBIENS
1871 - 1930

(R16#178) Lachance Monument

West Face:

IHS
LACHANCE

(R16#177) Belanger Monument

BELANGER

LEON N. 1949
ETELDA M. wife 1987
ALICE M. dau. 1949
LEDA M. MORIN 1948

East Face:

1864 CLEOPHAS LACHANCE 1935
son epouse
1867 AURELIE PAIEMENT 1906

(R16#179) **Dumaïs Monument**
West Face:

DUMAIS

East Face:

1908 EMILIEN J. DUMAIS 1973
1910 LEONA C. his wife 1993
1934 CHARLES E. their son 2003

(R16#181) **St. Pierre Monument**
ST. PIERRE

1893 WILLIE 1970
son epouse
1892 REINE LECLERC 1987
Jesus Marie Joseph

Marker Stones:
(R16#182)

ROSAIRE J LACHANCE
S Sgt US Army
World War II
Sep 24 1924 Apr 8 1993

(R16#188) **Fournier Monument**
South Face:

JOSEPH FOURNIER
decede le 22 Sept. 1917
a l'age de 56 ans.
Ici repose le corps de
AURELIE M. HAREL
epouse bien aimee de
JOSEPH FOURNIER
decedee le 23 Fevrier 1904
a l'age de 38 ans
Priez pour elle
FOURNIER

West Face:

HAROLD FOURNIER
1899 - 1965
son epouse
MARIE ANGE DEHETRE
1905 -

(R16#183) **VENISE M BEAULIEU LACHANCE**
wife of
ROSAIRE J LACHANCE
Apr 29 1933

(R16#184) **LOUIS E. ST. PIERRE**
June 5, 1920
March 14, 1998

(R16#185) **ST. PIERRE**
ISIDORE J. VALENTINE R.
June 16, 1926 Apr. 27, 1925
Feb. 22, 2005 Dec. 24, 1992

(R16#186) **Pax in Deo**
Ci - Git
MARIE GAMACHE
epouse de
EXIAR ST. PIERRE
decedee le 22 Juillet 1910
a l'age de 21 ans. 10 mois.
R. I. P.

(R16#189) **MARIE PARADIS**
1896 LIVERNOIS 1968
wife of
LUDGER PARADIS
1895 1934

(R16#187) **ISIDORE J B ST. PIERRE**
PFC US Army
World War II
Jun 16 1926 Feb 22 2005

Marker: U.S. Veteran

(R16#190) **OMER J PARADIS**
Sgt US Army
World War II
Mar 6 1922 Dec 26 1977

(R16#191) Ici
repose le corps
de
LUDDER LANGELIER
ne
le 19 Juillet 1886
decede
le 13 Mars. 1899

(R16#192) Fortin Monument
ALFRED FORTIN

EMMA GAMACHE
son epouse
nee le 31, Oct. 1849
decedee le 15 Nov. 1904
FORTIN

Marker Stones:
(R16#193) **MARIE A.**
1880 - 1975

(R16#194) **GEORGE A FORTIN**
Maine
Pvt US Army
World War II
May 17 1898 Oct 22 1968

(R16#195) **SIMONNE J. MICHAUD**
1903 - 1977

(R16#196) Fils de
PHILIPPE et EMILY
OUELLETTE
decede le 15 Juin 1912
a l'age de 8 ans et 8 mois

(R16#197) Lavigne Monument
East Face:
LAVIGNE
coeur sacre de Jesus ayez pitie de nous
West Face:

ALBERT H. LAVIGNE
1 Nov. 1874 - 10 Avril 1955
son epouse
BELZIMIRE LAVIGNE
13 Aout 1879 - 10 Sept. 1938
leur fils
RAOUL LAVIGNE
22 Avril 1905 - 14 Mars. 1993

Marker Stones:
(R16#198) Pere
ALBERT H. LAVIGNE
1874 - 1955

(R16#199) Mere
BELZIMIRE LAVIGNE
1879 - 1938

(R16#200) Fils
RAOUL J. LAVIGNE
1905 - 1993

(R16#201) St. Onge Monument

East Face:

ST. ONGE

Dites un "je vous salue, Marie"

West Face:

LUDGER ST. ONGE

30 Janv. 1879 - 14 Fev. 1958

son epouse

ANNA ST. ONGE

1 Juil 1882 - 7 Aout 1972

leur fille

MARGUERITE

8 Aout 1905 - 8 Juil. 1915

Marker Stones:

(R16#202) LUDGER

(R16#203) ANNA

(R16#205) JEAN M. RICHARD
1903 - 1962

(R16#206) FLORIDA M. RICHARD
1909 - 1970

(R16#204) Cloutier Monument

West Face:

CLOUTIER

Dites un "je vous salue, Marie"

East Face:

1879 JOACHIM CLOUTIER 1958

son epouse

1886 MARIE L. PLOURDE 1976

leurs enfants

1913 IRENE 1913

1921 JEANETTE 1929

1919 ROGER 1941

1926 DENISE 1998

(R16#207) CLEMENTINE RICHARD
1850 - 1927

(R16#208) MARIE F. RICHARD
1878 - 1942

(R16#209) HILAIRE A. RICHARD
1877 - 1955

(R16#211) Dionne Monument

DIONNE

1891 EMILE DIONNE 1965

son epouse

1892 MARIANNE DEMERS 1978

Dites nous un je vous salut Marie

(R16#210) OSWALD F. RICHARD
Feb. 29, 1912
Nov. 5, 1993

Marker Stones:

(R16#212) OREAN B. DIONNE
Mar. 26, 1920 -
wife of
ROBERT E. DIONNE

(R16#213) ROBERT E DIONNE
US Army
World War II
Oct 22 1916 Oct 15 2000

(R16#214) ~~Gamache~~ Monument

GAMACHE

The individual burial indications are carved upon the top surface of the wide marble curbing which surrounds this plot.

(R16#215) Epoux
HERMENEGILDE de THIBEAULT
1844 - 1930

(R16#216) Epouse
ROSALIE GAMACHE
1845 - 1915

(R16#217) Epoux
AMEDEE GAMACHE
1886 - 1920

(R16#218) Epouse
ROSANNA THIBEAULT
1884 - 1956

(R16#219) Daughter
MARIE ROSE GAMACHE
1911 - 1981

(R16#221) Anctil Monument

West Face:

ANCTIL
My Jesus mercy

East Face:

Apr. 21, 1857 MARTIAL ANCTIL Dec. 15, 1926
his wife
Feb. 21, 1858 CAROLINE LABBE July 4, 1914
their son
Aug. 30, 1890 EDDIE M. ANCTIL Oct. 10, 1968
his wife
Dec. 10, 1898 DELIA MICHAUD Apr. 11, 1992

(R16#220) Simpson Monument

SIMPSON
1888 ADELARD 1972
his wife
1889 DIANA LAVOIE 1935
In God's care

Marker Stone:

(R16#222) MONICA A. BERNIER
May 31, 1928
October 6, 1989

(R16#223) Lavoie Monument

West Face:

LAVOIE

East Face:

LOUIS B. LAVOIE
1871 - 1954
VICTORINE DION LAVOIE
1875 - 1939
PHILIP J. LAVOIE
1900 - 1953
AUGUSTINE DION CASTONGUAY
1871 - 1917

(R16#225) Lavallee Monument

LAVALLEE

Marker Stones:

(R16#226) MARIE ADELISE LAVALLEE
Sept. 22, 1891 - Jan. 21, 1955
epouse de
SAMUEL A. LAVALLEE

(R16#227) SAMUEL A. LAVALLEE
Nov. 1, 1891 - Jan. 5, 1957
epoux de
MARIE ADELISE LAVALLEE

(R16#229) IDA M. LAVALLEE
Mar. 24, 1882 - Feb. 22, 1960
epouse de
J. AIME LAVALLEE

(R16#230) PATRICK H. DUFFY
Feb. 24, 1910 - July 29, 1946
epoux de
LOUISIA M. LAVALLEE

(R16#231) LOUISIA M. DUFFY
Aug. 28, 1915 - Aug. 6, 1998
epouse de
PATRICK H. DUFFY

(R16#232) MENARD
epouse MARIE ANNA 1889 - 1972
epoux LEO 1886 - 1973

file
JEANNE A.
1916 - 2002

(R16#233) MENARD
GERARD A. JULIETTE F.
Nov. 26, 1918 Feb. 19, 1920
Apr. 11, 2004 Jan. 2, 2002

(R16#234) GERARD A MENARD
SF3 US Navy
Nov 26 1918 Apr 11 2004

Marker: U.S. Veteran

(R16#235) Fournier Monument

FOURNIER

CAMILLE NEOLLA
May 29, 1904 April 20, 1905
Nov. 18, 1992 May 24, 1971
In loving memory

(R16#224) Shannon Monument

North Face:

SHANNON

South Face:

ELIZABETH 1841 - 1912
MARY 1862 - 1939
ALEXANDER 1861 - 1940

(R16#228) WILFRED H.
HALL
1926 2006

Marker Stone:

(R16#236)

FOURNIER
FATHER MOTHER
1867 - 1939 1866 - 1948

(R16#237)

LEVESQUE
LUDGER J. BERNADETTE
1889 - 1982 1891 - 1969

(R16#238)

LEVESQUE
HENRICO T. CECILE M
Aug. 2, 1931 July 6, 1931
July 16, 2005

(R16#239) Top of stone:

FERDNAND
LEVESQUE

Face of stone:

decede
le 26. Sept. 1918
a l'age de 6 ans
et 9 mois

ST. JOHN THE BAPTIST CEMETERY - Range Layout

Range #17
Map #1

W E S T

A
C
C
E
S
S
R
O
A
D

N
O
R
T
H

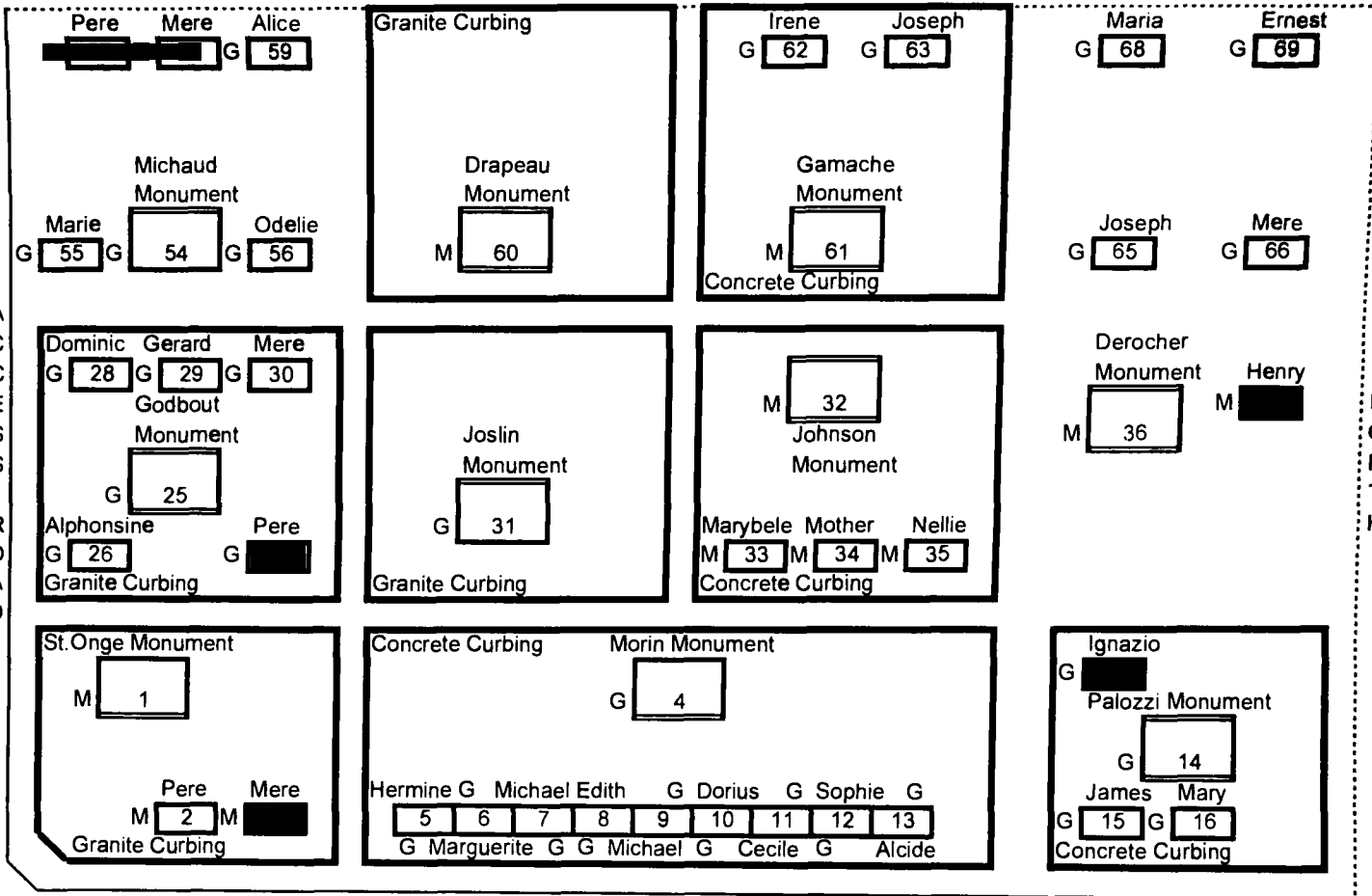

A C C E S S R O A D
E A S T

ST. JOHN THE BAPTIST CEMETERY - Range Layout

Range #17
Map #2

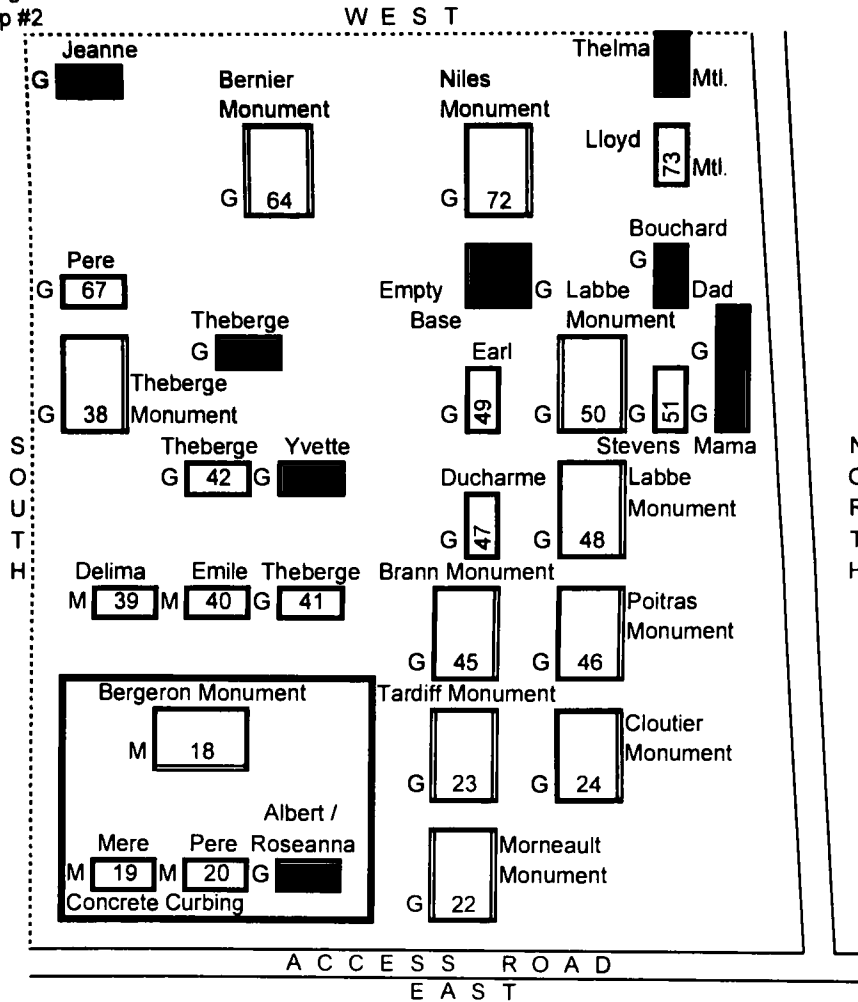

ST. JOHN THE BAPTIST CEMETERY - Range Layout

Range #17
Map #3

W E S T

A
C
C
E
S
S
O
R
Y
R
O
A
D

N
O
R
T
H

Pere 111 G Mere 112 G Carmen []
Sylvio 110 G
Eva 109 G
Desjardins Monument 108 G
Concrete Curbing

Alice 117 G Anna []
Morin Monument 114 M
Pere [] G Leo 116 G
Granite Curbing

Marie 122 G Rose []
Thibeault Monument 119 G
Mere 120 G Pere [] G
Granite Curbing

Bouchard Monument []
Dubreuil Monument G 129 []
Higgins Monument G []
124 G []

Pere 83 M Lapierre 78 M Mere 84 M 85 M
Caron Monument 82 M
Frederic []
Granite Curbing
Victor 79 M Germaine 80 M Frederic 81 G

Napoleon 87 Mtl. Philomene 88 Mtl.

Robert 93 G Louis 94 G George 95 G

Lisa Anne []
G []

Beaulieu Monument 86 G

Gamache Monument 89 G
Gamache 90 G Josephine 91 G Nap 92 G

Johansen Monument []
G 97 []
Cote Monument []
G 96 []

E A S T

ST. JOHN THE BAPTIST CEMETERY - Range Layout

Range #17
Map #4

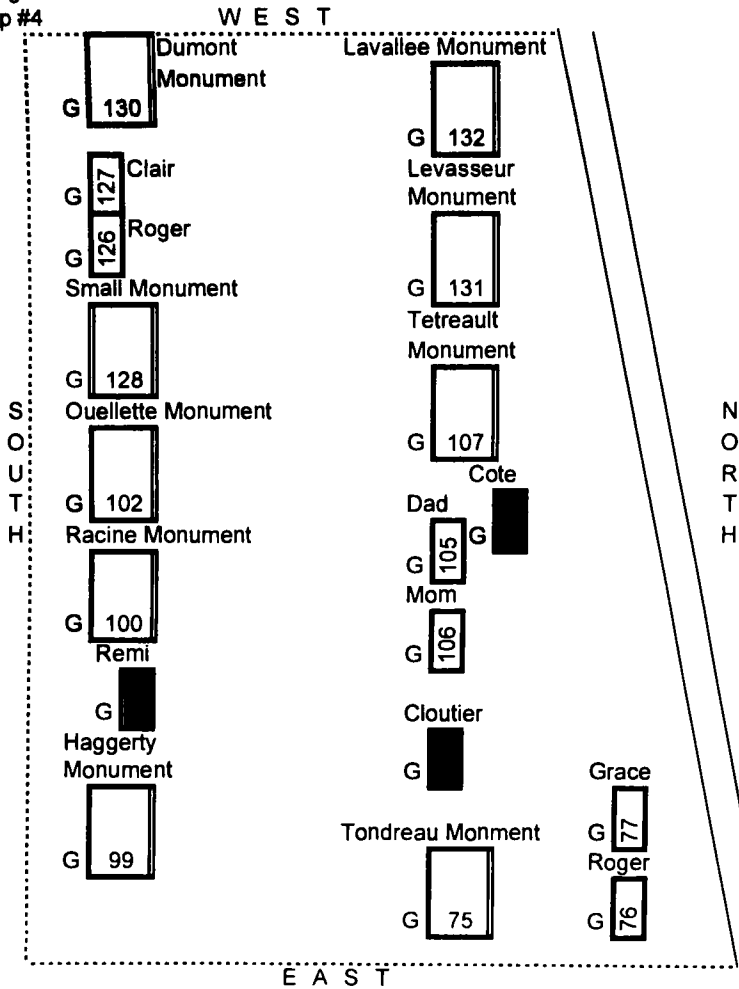

ST. JOHN THE BAPTIST CEMETERY - Range Layout

Range #17

Map #5

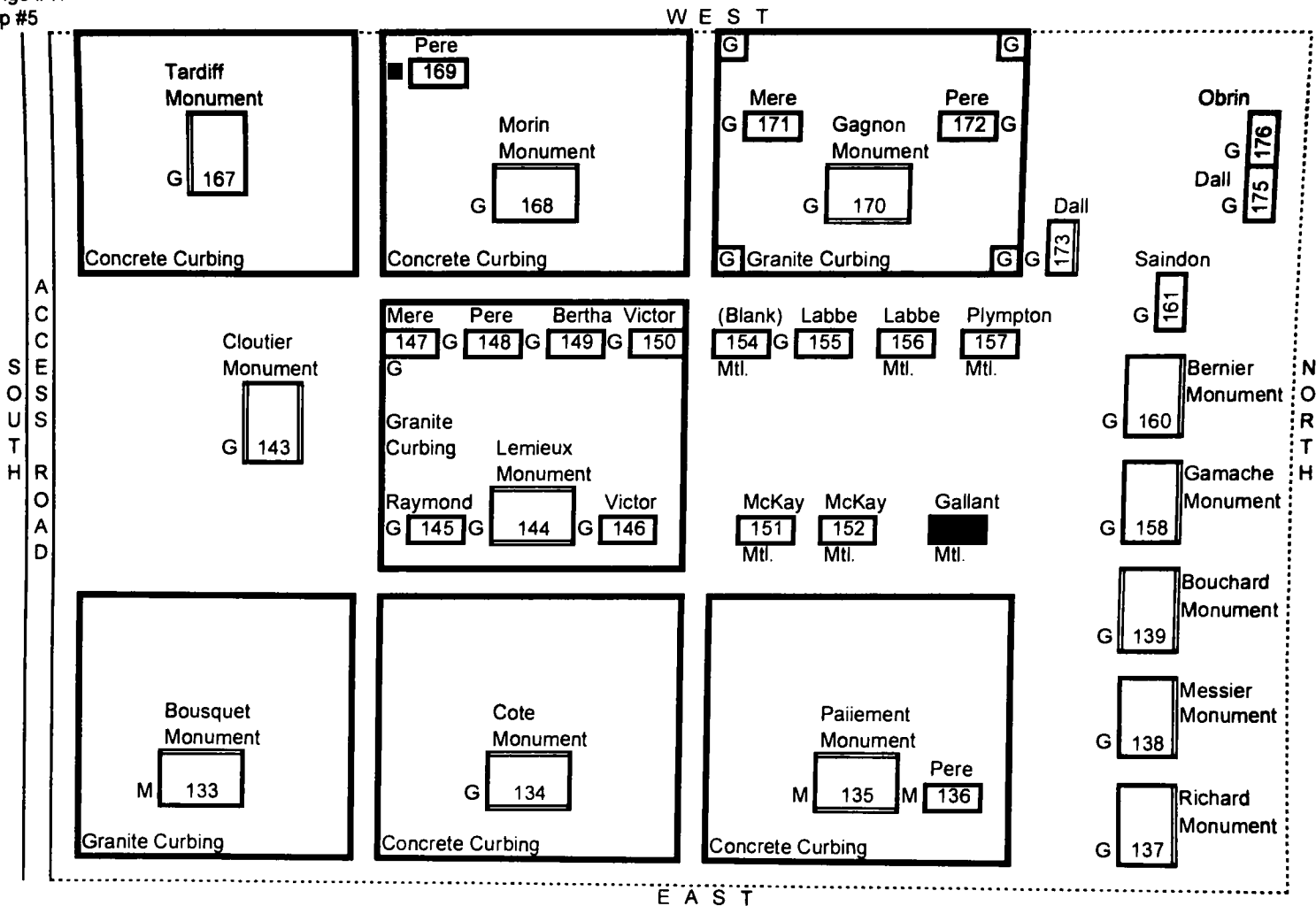

ST. JOHN THE BAPTIST CEMETERY - Range Layout

Range #17

Map #6

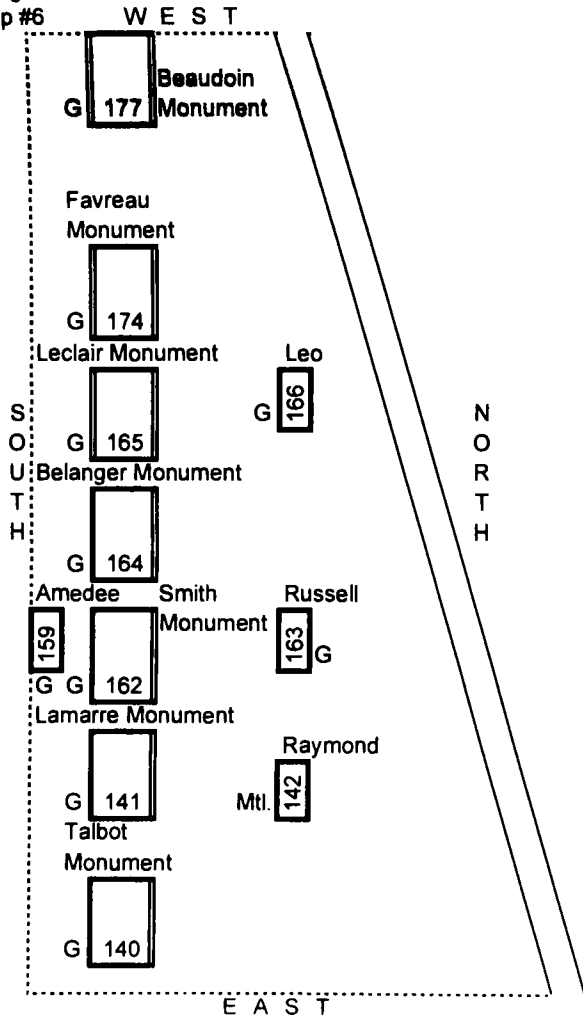

ST. JOHN THE BAPTIST CEMETERY - Range Layout

Range #17
Map #7

W E S T

A
C
C
E
S
S
O
R
Y
R
O
A
D

N
O
R
T
H

E A S T

Yvonne M **210** Eva M **211**
Leclerc Monument
M **207**
Mere M **208** Pere M **209**
Concrete Curbing

Daddy **214** Mama G **212**
Debra Mtl. Laffely Monument
Concrete Curbing

Brewer Monument
G **218**
Flanagan Monument
G **216**

Benjamin G **219**
James G **217**

Simard Monument
G **221** Mtl. **222** Joseph
Strahl G **220**
Caron Monument
G **205** Adelard G **206**

Decoster Monument
G **192**
Henrietta Mother Baby
G **193** G **194** G **195**
Granite Curbing

Pere G **200** Mere G **201**
Belanger Monument
G **196**
Arthur Camille Emelia
G **197** G **198** G **199**
Concrete Curbing

Livernois Monument
G **202**

Caron Monument
G **204**
Caron Monument
G **203**
St. Pierre Monument

Father G **180** Elie Monument
Mother G **179** G **178**
Concrete Curbing

Bisson Mtl. **181**

Poulin Monument
G **182**

Husband G **185** Wife G **186**

Gisele G **187** Dennis G **188**
Messier Monument
G **184**

G **191**
Rossignol Monument
G **190**
Menard Monument
G **189**

ST. JOHN THE BAPTIST CEMETERY - Range Layout

Range #17
Map #8

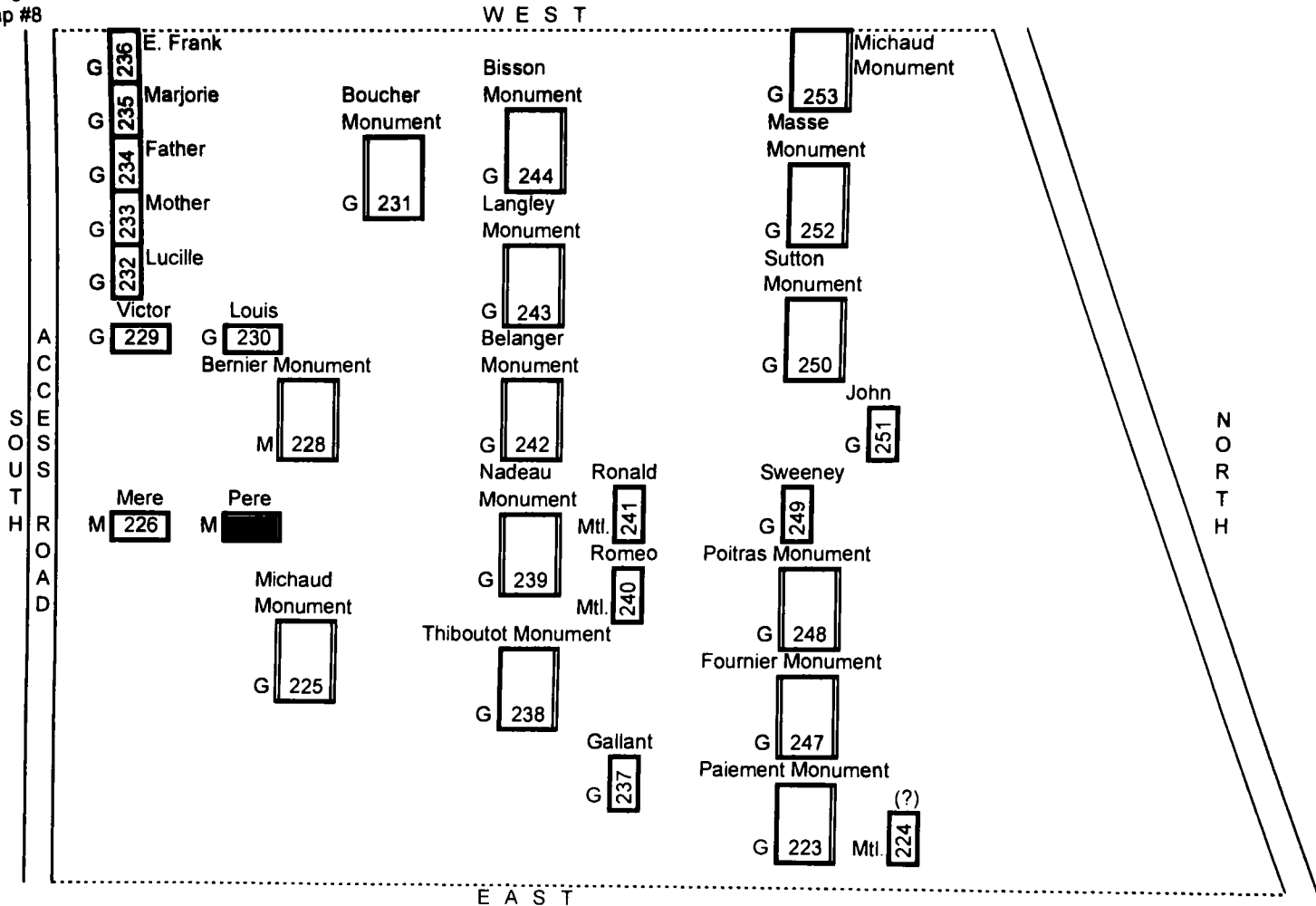

ST. JOHN THE BAPTIST CEMETERY - Range Layout

Range #17
Map #9

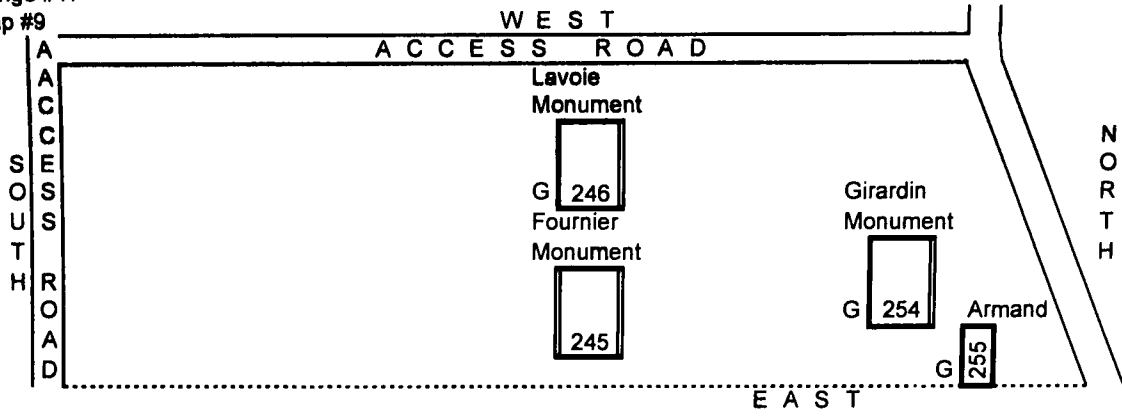

RANGE #17

(R17#1) St. Onge Monument

GEORGE ST. ONGE

1851 - 1936

son epouse

LEONTINE LAPOINTE

1856 - 1938

ST. ONGE

Marker Stones:

(R17#2) PERE

(R17#3) MERE

(R17#4) Morin Monument

MORIN

Marker: U.S. Veteran

Marker Stones:

(R17#5) HERMINE (R17#6) MARGUERITE
1874 - 1926 1915 - 1932

(R17#7) MICHAEL Sr. (R17#8) EDITH C.
1872 - 1943 1916 - 1965

(R17#9) MICHAEL Jr. (R17#10) DORIUS J MORIN
1909 - 1993 Maine
Pvt US Army

(R17#11) CECILE Jan 6 1907 Dec 22 1907

1903 - 1974

Marker: K. of C.

(R17#12) SOPHIE (R17#13) ALCIDE MORIN
1868 - 1943 1869 - 1925

(R17#14) Palozzi Monument

East Face:

IHS PALOZZI

West Face:

JAMES PALOZZI

Dec. 27, 1860 - March 4, 1940

his wife

MARY DI CLEMENTI

April 19, 1862 Nov. 20, 1932

IGNAZIO DI CLEMENTI

April 8, 1864 Dec. 17, 1938

Marker Stones:

(R17#15) JAMES

(R17#16) MARY

(R17#17) IGNAZIO
DI CLEMENTI

(R17#18) Bergeron Monument

INRI
JOSEPH BERGERON
1869 - 1944
LYDIA TREMBLAY
son epouse
1874 - 1934

Marker Stones:

(R17#19) **MERE**
(R17#20) **PERE**
(R17#21) **BERGERON**
ROSEANNA ALBER
1914 1905 - 19

(R17#22) Morneault Monument

North Face:

MORNEAULT

South Face:

PETER L. MORNEAULT
1907 - 1999
son epouse
URBANIE S. TALBOT
1914 -

(R17#23) Tardiff Monument

North Face:

TARDIFF
Say a Hail Mary

South Face:

1909 **GERALD L. TARDIFF** 19
his wife
1910 **CECILE M. POULIOT** 20

(R17#24) Cloutier Monument

CLOUTIER
THEOPHILE Sr. In ILDEA
1885 - 1976 loving 1889 - 1974
memory

(R17#25) Godbout Monument

East Face:

IHS
GODBOUT

West Face:

IHS
ALPHONSINE DRAPEAU
born Feb. 8, 1860 died Nov. 14, 1931

Marker: U.S. Veteran

Marker Stones:

(R17#26) **ALPHONSINE** (R17#27) **Pere**
ADOLPHE GODBOUT
1866 - 1943
(R17#28) **DOMINIC J GODBOUT** (R17#29) **GERARD J GODBOUT**
Sgt US Army **20 Mai 1902 - 28 Oct 1990**
World War II **son epouse**
Dec 8 1905 Jan 12 1980
(R17#30) **Mere** **GENEVIEVE A. RODRIQU**
CLAUDIA GODBOUT **5 Jul 1913 - 3 Jul 1956**
1873 - 1965

(R17#31) Joslin Monument

ALEXANDER A. JOSLIN
July 17, 1857 - Oct. 9, 1927
NELLIE E. his wife
Mar. 19, 1865 - Feb. 26, 1935

(R17#32) Johnson Monument

East Face:
JOHNSON
West Face:
CATHERINE A. JOHNSON
1879 - 1968
MARYBELLE JOHNSON HAYE
1908 - 1931

(R17#36) Derocher Monument

East Face:
DEROCHER
"My Jesus mercy"
West Face:
ALBERT G. DEROCHER
1882 - 1967
epoux de
REBECCA COTE
1887 - 1954
JOSEPH A. DEROCHER
1916 - 1934
MARIE D.
1886 - 1963

Marker: U.S. Veteran

Marker Stones:
(R17#33) MARYBELLE
(R17#34) MOTHER
(R17#35) NELLIE R.
MERRYMAN
1883 - 1949

Marker Stone:
(R17#37) HENRY W DEROCHER
Maine
S Sgt 2 Mt Bn 2 Mar Div
Korea
Jan 7 1925 Sept 12 1956

(R17#38) Theberge Monument

THEBERGE

Marker Stones:
(R17#39) DELIMA FORTIN
THEBERGE
1880 - 1935
(R17#42) THEBERGE
In loving memory
ERNEST J. LUCIENNE
1912 - 1973 1915 -
(R17#43) YVETTE THEBERGE
Jan. 7, 1918
Sept. 18, 1985

(R17#40) EMILE B. THEBERGE
1877 - 1939
(R17#41) THEBERGE
Jesus Mary Joseph
EMIILE O. EXILIA
1907 - 1967 1904 - 1981
(R17#44) ELPHEGE W. THEBERGE
1910 - 1976
his wife
ALTHEA I. McMACKIN
1912 - 2007

(R17#45) Brann Monument

North Face:

BRANN

Top of stone:

DANA E.
1948 - 1974

(R17#46) Poitras Monument

POITRAS

SAMUEL P. In FERNANDE M.
1906 - 1997 God's 1906 - 1998
care

(R17#47)

ROBERT DUCHARME

1922 - 1987

his wife

CLAIRE PINETTE

1923 - 1984

(R17#48) Labbe Monument

LABBE

In
God's
care

ROMUALD O.

LORETTA M

June 22, 1930 May 4, 1998 Oct. 27, 1934

(R17#49)

EARL

WILLIAM T. Jr.

GILBERTE E.

1916 - 1999

1916 - 1997

(R17#50) Labbe Monument

North Face:

LABBE

South Face:

1922 ROBERT J. LABBE 2002

his wife

1917 HELEN M. CLOUTIER 1974

Marker Stones:

(R17#51)

JENSINA G. STEVENS

1967 - 1991

beloved wife of ROBERT C. STEVENSON

(R17#52)

MAMA

(R17#53)

DAD

(R17#54) Michaud Monument

JOSEPH MICHAUD

1863 - 1933

AURELIE son epouse

1863 - 1946

MICHAUD

Marker Stones:

(R17#55)

MARIE-ANNA

(R17#56)

O DELIE

(R17#57)

PERE

(R17#58)

MERE

(R17#59)

ALICE

(R17#60) Drapeau Monument

West Face:

DRAPEAU

East Face:

JOSEPH A. DRAPEAU

1878 - 1930

his wife

MARIE LOUISE GAGNON

1875 - 1949

(R17#61) Gamache Monument

West Face:

GAMACHE

East Face:

BATISTE GAMACHE

1867 - 1932

son epouse

LUCILE FREGEAU

1869 - 1952

Marker Stones:

(R17#62)

**Beloved daughter
IRENE J. BOUCHARD**

September 7, 1922

November 7, 2002

(R17#63)

**JOSEPH A. BOUCHARD
27 Sept. 1900 - 12 Mars 19**

son epouse

YVONNE GAMACHE

23 Juin 1897 - 3 Mai 198

(R17#64) Bernier Monument

South Face:

BERNIER

North Face:

1882 GEORGE T. BERNIER 1967

son epouse

1885 HELENA DIONNE 1937

1909 MARIA 2004

1912 JOSEPH 1935

1914 JEANNE 2000

1921 ERNEST 2006

BERNIER

Marker Stones:

(R17#65)

**JOSEPH
1912 - 1935**

(R17#66)

MERE

(R17#67)

PERE

(R17#68)

**MARIA
1909 - 2004**

(R17#69)

**ERNEST J BERNIER
Sgt US Army
World War II
Jun 10 1921 Apr 4 2006**

(R17#70)

**JEANNE
1914 - 2000**

(R17#71)

**FRANCOIS X. GERTRUDE M.
1913 - 1979 1912 - 2003
BOUCHARD**

(R17#72) Niles Monument

NILES
LLOYD G. THELMA A.
1919 - 1974 1922 - 2004

Marker: U.S. Veteran

Marker Stone:
(R17#73)

LLOYD G NILES
Maine
1st Lt Army Air Forces
World War II
Mar 22 1919 Apr 9 1974

(R17#74)

THELMA A NILES
wife of LLOYD G NILES
May 23 1922 Jan 14 2004

(R17#75) Tondreau Monument

TONDREAU
LORRAINE F. ROGER O.
1915 - 1974 1911 -

In loving memory

Marker: U.S. Veteran

Marker Stones:

(R17#76) ROGER O TONDREAU Sr (R17#77)
PFC US Army
World War II
Dec 16 1911 Jul 31 2004

GRACE I MORJIN
wife of ROGER TONDREAU
November 28 1914
October 31 1986

(R17#78) Caron Monument

West Face:

Famille
A. CARON

East Face:

ARTHUR CARON
1866 - 1941
AMANDA son epouse
1874 - 1932
MARIE ANNE R. MUHLEIB
1896 - 1984

Marker Stones:
(R17#79)

VICTOR A
CARON D.D.S.
1905 - 1968

(R17#80)

GERMAINE N.
CARON
1918 - 2007

(R17#81)

FREDERIC J.
CARON M.D.
1905 - 1981

(R17#82) FREDERIC F.
28 Oct. 1945
2 Jan. 1946

(R17#83) PERE

(R17#84) LUCIENNE
LAPIERRE
1911 - 1934

(R17#85) MERE

(R17#86) Beaulieu Monument

West Face:

Our art
Father in
who Heaven
BEAULIEU
EMILE BEAULIEU
1903 - 1978
his wife
IDA BEAULIEU
1907 - 1981

East Face:

NAPOLEON BEAULIEU
1871 - 1931
his wife
PHILOMENE BEAULIEU
1877 - 1967
daughter
ALICE BEAULIEU
1898 -

Marker Stones:

(R17#87) NAPOLEON BEAULIEU
1871 - 1931

(R17#88) PHILOMENE BEAULIEU
1877 - 1967

(R17#89) Gamache Monument

GAMACHE
In God's care

Marker: U.S. Veteran

Marker Stones:

(R17#90) CLARINTHE GAMACHE
1890 - 1932
CAROL ANN HUARD
1950 - 1951

(R17#91) Epouse
JOSEPHINE B. BOLDUC
15 Jul. 1886
15 Juin 1969
Priez pour moi

(R17#92) Epoux
NAP J. GAMACHE
7 Sept. 1886
13 Nov. 1956
-Dites-un-ave-

(R17#93) ROBERT L GAMACHE
Maine
Pvt US Army
World War II
July 4 1917 Feb 7 1965

(R17#94) LOUIS I GAMACHE
Sgt US Army Air Corps
Nov 21 1920 May 23 1987

(R17#95) GEORGE A GAMACHE
S Sgt US Marine Corps
World War II
Feb 10 1913 Dec 20 1981

(R17#96) Cote Monument

COTE
"SONNY" "CONNIE"

ALBERT A.
July 18, 1929
Sept. 10, 2001

July 21, 1956
Together forever

CONSTANCE A.
Mar. 16, 1930
Feb. 7, 1999

(Note: Entwined wedding
rings above center date.)

(R17#97) Johansen Monument

JOHANSEN
ROBERT W. NANCY L.
Mar. 25, 1939 Dec. 18, 1938
Mar. 8, 1976

Marker Stone:
(R17#98)

Beloved daughter
LISA ANNE JOHANSEN
December 2, 1962
January 5, 1988

(R17#99) Haggerty Monument

HAGGERTY
DENNIS W. CATHERINE J.
Feb. 9, 1910 Oct. 31, 1910
Jan. 2, 1989

(17#100) Racine Monument

Hail Mary
RACINE
EMILIEN (FRITZ)
1910 - 1974
his wife
IRENE
1912 - 1978

(R17#102) Ouellette Monument

OUELLETTE
1902 PHILIP 1974
his wife
1900 LUCIENNE I. 1996
In loving memory

Marker Stone:
(R17#101) REMI G. RACINE S
May 2, 1938
Nov. 27, 1994

(R17#103)

CLOUTIER
ALFRED J. NELLIE S.
1916 - 1974 1914

(R17#104)

MARIE A. JOSEPH H
1907 - 1976 1911 - 1987
COTE

(R17#105) DAD

(R17#107)

TETREAULT
ARTHUR J. ANNA E.
1905 - 1974 1906 - 1990
In loving memory

(R17#106) MOM

(R17#108) Desjardins Monument

TELESPHORE DESJARDINS
1863 - 1937
son epouse
EUGENIE DRAPEAU
1863 - 1944
DESJARDINS

Marker Stones:

(R17#109) EVA M. (R17#111) PERE
1896 - 1979

(R17#110) SYLVIO T. (R17#112) MERI
1894 - 1976

(R17#113) CARMEN A.
1899 - 1966

(R17#114) **Morin Monument**

ERNEST MORIN

1872 - 1932

son épouse

EUGENIE LAPIERRE

1869 - 1961

MORIN

Marker Stones:

(R17#115)

PERE

(R17#116)

LEO
1905 - 1984

(R17#117)

ALICE
1909 - 1990

(R17#118)

ANNA
1902 - 1990

(R17#119) **Thibeault Monument**

THIBEAULT

Marker Stones:

(R17#120)

Mere
CHRISTINE
1875 - 1935

(R17#121)

Pere
AUGUSTE
1861 - 1940

(R17#122)

MARIE J.
MURPHY
1896 - 1978

(R17#123)

ROSE ANNA
1902 - 1986

(R17#124) **Higgins Monument**

HIGGINS

BEATRICE P. WALTER L.
Sept. 17, 1918 June 12, 1918
Apr. 5, 1980 Oct. 1, 1990

(R17#125) **Dubreuil Monument**

DUBREUIL

ROGER R. CLAIRE
Mar. 25, 1924 Oct. 12, 1922
July 31, 1976
Staff Sargent

(R17#128) **Small Monument**

North Face:

SMALL

ARTHUR ALICE HELEN

South Face:

ARTHUR A. SMALL

June 19, 1904 Aug. 28, 1985

ALICE M. his wife

Mar. 8, 1901 Dec. 11, 1989

HELEN A. their daughter

Aug. 21, 1941

Marker: U.S. Veteran

Marker Stones:

(R17#126)

ROGER R DUBREUIL
Tec 4 US Army
World War II
1924 1976

(R17#127)

CLAIRE B. DUBREUIL
1922

(R17#130) **Dumont Monument**

DUMONT

1899 OLIVER J. 1974 1900 ROSE 1980
Jesus Marie Joseph

(R17#129) **Bouchard Monument**

BOUCHARD

VICTOR MATTIE

1892 - 1977 1902 - 1979

(R17#131) ~~Levasseur~~ Monument

LEVASSEUR
ALPHONSE C. LAURA A.
1909 - 1974 1918 - 1977

(R17#132) Lavallee Monument

LAVALLEE
JOSEPH R. LORRAINE I
1914 - 1974 1916 - 2003

(R17#133) Bousquet Monument

BOUSQUET
ANNA E. BOUSQUET
1885 - 1973
LORRAINE G. BOUSQUET
1914 - 1986
SIMONNE BOUSQUET
1911 - 1929

(R17#134) Cote Monument

West Face:
COTE
1902 JOSEPH L. 1992 Thy will
his wife be done
1905 CECILE L. 1975
East Face:
1868 ARTHUR L. LABBE 1932
his wife
1871 MARIE LABBE 1942
1899 AMABLE ST.PIERRE 1950
his wife
1902 LEONIE ST.PIERRE 1978

(R17#135) Paiement Monument

West Face:
PAIEMENT
East Face:
1856 XAVIER PAIEMENT 1939
1868 ALBINA his wife 1947
1888 ALICE their dau. 1935
1899 JOHN B. BERUBE 1955
1890 CEDEA P. his wife 1967

Marker Stone:
(R17#136) PERE
1856 - 1939

(R17#137) Richard Monument

RICHARD
GODIAS J. ANNIE P.
1901 - 1980 1904 - 1974

(R17#138) Messier Monument

MESSIER
HENRY ETHEL
In loving memory

(R17#139) Bouchard Monument

North Face:
BOUCHARD
Forever together in God's care
South Face:
Nov. 26, 1936
WILFRED E. BOUCHARD
Apr. 19, 1913 - Oct. 30, 1993
his wife
FLORENCE Y. LIVERNOIS
May 16, 1914 -
We'll never walk alone

(R17#140) Talbot Monument

TALBOT
EMILE J. FLORA B.
1908 - 1985 1911 - 1984
In loving memory

Note: Date at top across 2 rings.

(R17#141) ~~Lamarre~~ Monument

LAMARRE
LORETTE RAYMOND ALICE
1924 - 1973 1923 - 2001 1892 - 1976

Marker: U.S. Veteran

Marker Stone:

(R17#142) RAYMOND A LAMARRE
1st Sgt US Army
World War II
Jan 7 1923 Aug 14 2001

(R17#143) Cloutier Monument

South Face:

CLOUTIER
If suis la resurrection et la vie

North Face:

JOSEPH L. CLOUTIER
27 Mai 1886 - 18 Oct. 1957
epouse, ALICE M. FORTIN
11 Decembre 1893 - 15 Juillet 1930
epouse, ANTOINETTE M. COTE
29 Avril 1896 - 30 Mai 1999
mere, CLEMENTINE F. CLOUTIER
17 Janvier 1852 - 6 Mai 1932
ALPHONSE CLOUTIER
16 Decembre 1875 - 26 Novembre 1948
ADELARD CLOUTIER
16 Mars 1913 - 27 Avril 1982

(R17#144) Lemieux Monument

West Face:

FERDINAND J. LEMIEUX
1869 - 1948
son epouse
OLYMPHE M. LIVERNOIS
1871 - 1947
LEMIEUX

East Face:

RAYMOND N. LIVERNOIS
1906 - 1934
VICTOR J. LEMIEUX
1900 - 1992
son epouse
ALBERTA F. BERNIER
1907 - 2005

Marker: U.S. Veteran

(R17#151) PAUL McKAY
1857 - 1935

(R17#152) FLORANTINE McKAY
1855 - 1940

(R17#153) ROSE GALLANT
1887 - 1943

(R17#154) (Blank)

Marker Stones:

(R17#145) RAYMOND

(R17#146) VICTOR J.

(R17#147) MERE

(R17#148) PERE

(R17#149) BERTHA F.

(R17#150) VICTOR J F LEMIEUX
US Navy
Apr 30 1932 Apr 30 1996

(R17#155) AGNES McKAY LABBE
1891 - 1984

(R17#156) **DEMETRIUS LABBE**
1882 - 1953

(R17#157) **DAVID H. PLYMPTON**
1877 - 1947

(R17#158) **Gamache Monument**

GAMACHE
AMEDEE J. MARIE ROSE
Aug. 3, 1912 May 29, 1916
Oct. 19, 1988 Apr. 18, 2006

Marker Stone:

(R17#159) **AMEDEE J GAMACHE**
Pvt US Army
World War II
Aug 3 1912 Oct 19 1988

(R17#160) **Bernier Monument**

BERNIER
1892 JOSEPH A. 1975
his wife
1895 ALBERTINE FORTIN 1983
In loving memory

(R17#161) **SAINDON**
IRENEE G. CECILE M.
1910 - 1975 1907 - 2007

(R17#162) **Smith Monument**

SMITH
RUSSELL ISABELLE
1916 - 1974 1917 - 2006

Marker Stone:

(R17#163) **RUSSELL E SMITH**
Massachusetts
Sgt Army Air Forces
World War II
Nov 3 1916 April 4 1974

(R17#164) **Belanger Monument**

BELANGER
JOHN B. YVONNE
1899 - 1973 1899 - 1975

(R17#165) **Leclair Monument**

North Face:

LECLAIR

South Face:

LEO A. LECLAIR
Aug. 25, 1895 - Aug. 27, 1973
YVONNE R. his wife
June 26, 1897 - Feb. 6, 1985

(R17#167) **Tardiff Monument**

EDWARD TARDIFF
1889 -
wife
MARY A. McGLENN
1890 - 1930
TARDIFF

Marker: U.S. Veteran

Marker Stone:

(R17#166) **LEO A LECLAIR**
Maine
Pvt US Army
World War I
Aug 25 1895 Aug 27 1973

(R17#168) **Moria Monument**

NATHANIEL

1872 - 1935

son epouse

AMANDA

1883 - 1979

ULRIC J.

1906 - 1980

MORIN

Marker Stone:

(R17#169) PERE

son epouse

BERTHA Y.

1904 - 1993

(R17#170) **Gagnon Monument**

West Face:

GAGNON

East Face:

ARTHUR GAGNON

1881 - 1942

son epouse

MARIE LOUISE COUILLARD

1881 - 1940

Marker Stones:

(R17#171) MERE

(R17#172) PERE

(R17#174) **Favreau Monument**

North Face:

IHS

FAVREAU

(R17#173) **JACQUELINE R. DALL**

August 21, 1928

April 17, 1975

her beloved daughter

LISA ANNE CARTER

March 14, 1966

May 5, 2008

South Face:

1899 JOSEPHAT A. FAVREAU 1973

his wife

1904 MILDRED P. HUNTER 1994

(R17#176) **BLANCH B. O'BRIN**

1920 -

(R17#175) **JACQUELINE R. DALL**

1928 - 1975

(R17#178) **Elie Monument**

ELIE

ARTHUR H. ELIE

1889 - 1930

wife

ALMIDA E. BRILLANT

1889 - 1986

(R17#177) **Beaudoin Monument**

North Face:

BEAUDOIN

In loving memory

South Face:

1927 ROLAND J. BEAUDOIN 1980

his wife

1927 MURIEL C. MESSIER 2004

son

1953 RONALD D. BEAUDOIN 1973

Marker Stones:

(R17#179) MOTHER

(R17#180) FATHER

(R17#181) **ROLAND E BISSON**
US Army
World War II
1914 1998

(R17#182) **Poulin Monument**
South Face:

POULIN
Jesus Marie Joseph

North Face:

POULIN
1896 **JEAN B. POULIN Sr.** 1990
son epouse
1898 **CORINNE POULIN** 1966
leur enfants
1924 **CECILE POULIN** 1929
1936 **JEAN B. POULIN Jr.** 1937

(R17#184) **Messier Mounment**

West Face:

MESSIER
My Jesus mercy

East Face:

1892 **AVELIN MESSIER** 1941
his wife
1898 **CLAUDIA PHILIPPON** 1972
their son
1923 **LEO A. MESSIER**
his wife
1924 **GISELE J. LAVOIE** 2005
their son
1949 **DENNIS P.** 1991

Marker: U.S. Veteran

Marker Stone:

(R17#183) **JEAN POULIN Jr.**
1935 - 1937

Marker Stones:

(R17#185) **Husband**
AVELIN
1892 - 1941

(R17#186) **Wife**
CLAUDIA
1898 - 1972

(R17#189) **Menard Monument**

MENARD

LIONEL K. ROLANDE E.
1914 - 1989 1908 - 1997

(R17#187) **GISELE J. MESSIER**
Dec. 15, 1924 - May 15, 2005
wife of
LEO A. MESSIER

(R17#190) **Rossignol Monument**

ROSSIGNOL

LEO CECILE
1918 1922
1941 son **DONALD** 1973

(R17#188) **DENNIS P MESSIER**
Sgt US Air Force
Vietnam
Jul 16 1949 Sep 24 1991

(R17#191) **St. Pierre Monument**

IHS
ST. PIERRE

FLORA A. OMER
1910 - 1999 Married 1929 1906 - 1982

(R17#192) DeCoster Monument

DeCOSTER
FRED DeCOSTER
1872 - 1963
MARY AGNES
1870 - 1931
their daughter
MARY HENRIETTA
1900 - 1982

Marker Stones:

(R17#193) HENRIETTA
(R17#194) MOTHER
(R17#195) Baby
KATHERINE R.
CALLAGHAN
died - 1938

(R17#196) Belanger Monument

South Face:

BELANGER
BERNIER

North Face:

ARTHUR BERGERON
1889 - 1938
CAMILLE BERNIER
1892 - 1948
EMELIA son epouse
1900 - 1949

LEONCE BELANGER
1873 - 1947
EMMA son epouse
1874 - 1952
ALICE BELANGER
1905 - 2001

Marker Stones:

(R17#197) ARTHUR (R17#198) CAMILLE
(R17#199) EMELIA (R17#200) PERE
(R17#201) MERE

(R17#203) Caron Monument

CARON
1904 ARMAND A. 1976
his wife
1913 ELIETTE 1994
Jesus Mary Joseph

(R17#202) Livernois Monument

LIVERNOIS
Dad Mom
PHILIP, Sr. ANTOINETTE
1906 - 2003 1910 - 1985

(R17#205) Caron Monument

CARON
ADELARD E. ROSE M.
1919 - 1993 1924 -

(R17#204) Caron Monument

CARON
Husband Wife
ROLAND W. EVELYN M.
1913 - 2002 1917 - 1992

Marker: U.S. Veteran

Marker Stone:

(R17#206)

ADELARD E CARON
S1 US Navy
World War II
Dec 18 1919 Mar 16 1993

(R17#207) Leclerc Monument

South Face:

JULES LECLERC
1861 - 1933
son epouse
CELINA CARON
1857 - 1933
LECLERC

(R17#212) Laffely Monument

EMILE E. LAFFELY
1903 - 1951
son epouse
JEANNETTE F. LEVESQUE
1903 - 1989

West Face:

EVA
1888 - 1980
YVONNE
1900 - 1977

Marker Stones:

(R17#213) **DEBRA ANNE PINETTE**
Nov - 1959

(R17#214) **DADDY**

(R17#215) **MAMA**

Marker Stones:

(R17#208) **MERE**

(R17#209) **PERE**

(R17#210) **YVONNE**

(R17#211) **EVA**

(R17#216) Flanagan Monument

North Face:

FLANAGAN

Marker: U.S. Veteran

South Face:

JAMES M. FLANAGAN
1912 - 1975

Marker Stone:

(R17#217)

JAMES M FLANAGAN
1 Lt US Army
World War II
1912 1975

(R17#218) Brewer Monument

BREWER

BENJAMIN **HILDA A.**
1926 - 1976 1928 - 2000
Husband Married July 6, 1948 Wife

Marker: U.S. Veteran

Marker Stone:

(R17#219)

BENJAMIN R BREWER Jr
BM2 US Navy
World War II
1926 1976

(R17#220) **MARY M. STRAHL**
March 3, 1944
June 26, 1987

(R17#221) **Simard Monument**
SIMARD
JOSEPH T. VIOLA L.
1913 - 2005 1920 - 1983
1967 ROBERT E. 1973

(R17#223) **Paieiment Monument**
PAIEMENT

DOMINIQUE VERA
1905 - 1973 1909 - 1990
In loving memory

Marker Stone:
(R17#224) (No name)
1939 - 2002

Marker: U.S. Veteran

Marker Stone:
(R17#222) **JOSEPH T SIMARD**
ADRC US Navy
Korea
Apr 12 1913 Jun 25 2002

(R17#225) **Michaud Monument**
South Face:

MICHAUD
Husband Wife
HONORE MICHAUD DELIA LACHANCE
Oct. 19, 1890 Mar. 16, 1894
Apr. 8, 1959 Sept. 18, 1987
"Please say a Hail Mary"

North Face:

AURELE MICHAUD
Feb. 17, 1861 - Aug. 3, 1931
his wife
LOUISE MENARD
Oct. 3, 1859 - Jan. 14, 1938

Marker Stones:
(R17#226) **MERIE**
(R17#227) **PERE**

(R17#228) **Bernier Monument**
South Face:

ZEPHIRIN BERNIER
1876 - 1960
son epouse
LAURA BRASARD
1885 - 1932
BERNIER

North Face:

GEORGE F. BERNIER
1910 - 1993
son epouse
LUCILLE DOYON
1915

Marker Stones:
(R17#229) **VICTOR R BERNIER**
Maine
PFC Co E 314 Infantry
World War II BSM PH
Sept 12 1911 Aug 7 1964

(R17#230) **LOUIS A BERNIER**
Massachusetts
PFC Co A 86 Engineer Bn
World War II PH
Oct 15 1914 Apr 15 1967

(R17#231) **Boucher Monument**

BOUCHER
 1879 FRANCOIS E. 1940
 son epouse
 1882 ALMA E. DUFRESNE 1939
 1910 EMILE FRANK 1955
 son epouse
 1912 MARJORIE JOHNSTON 1974

Marker Stones:
 (R17#232) LUCILLE G.
 1912 - 1983
 (R17#233) MOTHER
 (R17#234) FATHER
 (R17#235) MARJORIE
 (R17#236) E. FRANK

(R17#237)

GALLANT
 LEO J. BERNICE J.
 July 25, 1902 Aug. 25, 1904
 Mar. 10, 1976 Mar. 26, 1979

(R17#238) **Thiboutot Monument**

THIBOUTOT
 ALPHONSE V. ALDEA
 April 5, 1913 May 11, 1911
 Apr. 22, 2002 July 3, 1996

(R17#239) **Nadeau Monument**

North Face:

IHS
 NADEAU

"All I ask of you is forever to remember me as loving you."

South Face:

ROMEO "RED" NADEAU
 February 13, 1918 - August 5, 1984
 his wife
 MARCELLE B. BISSON
 July 4, 1923 -
 July 4, 1946
 their daughter their son
 PAULINE A. NADEAU RONALD J. NADEAU
 May 7, 1951 January 31, 1965
 December 17, 1996

(Note: Centered date above is across two linked rings.)

Marker Stones:

(R17#240) ROMEO NADEAU (R17#241) RONALD J NADEAU
 Tec 4 US Army Jacob's Daddy
 World War II Jan 31 1965 Dec 17 1996
 Feb 13 1918 Aug 5 1984

(R17#242) Belanger Monument

North Face:

BELANGER
In God's care

South Face:

RUSSELL J. BELANGER
Mar. 5, 1929 -
his wife
MADELEINE F. SENECAL
July 30, 1929 - July 30, 1989
their son
MICHAEL J. BELANGER
Nov. 6, 1957 - Aug. 11, 1993

(R17#244) Bisson Monument

BISSON

1929 CLAIRE 1982 1927 ROSAIRE

(R17#246) Lavoie Monument

LAVOIE
WILFRID L.
1898 - 1978
IRMA JEAN
1897 - 1978

(R17#248) Poitras Monument

North Face:

POITRAS
Jesus Marie Joseph

South Face:

1920 EDWARD J. POITRAS 2004
son epouse
1921 EMILIA J. OUELLETTE 1972

(R17#243) Langley Monument

LANGLEY

PAUL M. RENA
1905 - 1992 1906 - 1993

(R17#245) Fournier Monument

North Face:

FOURNIER

South Face:

EMILE A. FOURNIER
Nov. 10, 1903 July 31, 1999
ALICE his wife
Oct. 8, 1901 May 30, 1979
CLAUDE G. their son
Oct. 3, 1935

(R17#247) Fournier Monument

North Face:

FOURNIER

South Face:

GEORGE W. FOURNIER
Oct. 5, 1907 Mar. 15, 1998
MARIE LAURE his wife
Mar. 30, 1911 Mar. 21, 1972

(R17#249)

SWEENEY

EDWARD H.
1904 - 1972

CHARLOTTE A
1902 - 1989

(R17#250) Sutton Monument

SUTTON

IHS
JF
JOHN R. FLORENCE B.
July 25, 1919 Apr. 12, 1921
Oct. 2, 1984

Marker Stone:

(R17#251) JOHN R SUTTON
MSgt US Army
World War II
1919 1984

Marker: U.S. Veteran

(R17#252) Masse Monument

MASSE

FERDINAND A. MARIE LOUISE

1905 - 1975

1908 - 1994

(R17#253) Michaud Monument

MICHAUD

ROCH CLAIRE

1910 - 1981 1907 - 1995

In loving memory

(R17#254) Girardin Monument

GIRARDIN

1917 ARMAND L. 1972

his wife

IRENE C. MICHAUD

1914 - 1999

In loving memory

(R17#255)

ARMAND L GIRARDIN

Maine

Pvt US Marine Corps

World War II

May 22 1917 Oct 6 1972

ARMAND L. GIRARDIN

**ST. JOHN THE BAPTIST CEMETERY
PINE STREET & BATH ROAD
BRUNSWICK, MAINE**

CUMBERLAND COUNTY

**Volume 3 of 3
Ranges 18 through 20**

Donald & Mark Cheetham, 2007 - 2009

St. John the Baptist Cemetery

St. John the Baptist Cemetery is located between Pine Street and Bath Road in Brunswick, Cumberland County, Maine and is known by most simply as St. John's Cemetery. It is situated on the north side of Pine St. and the south side of Bath Rd. bordered by the Brunswick Naval Air Station on the east side and Varney Cemetery on the west side. The cemetery consists of 3,643 stones, the earliest dated 1854, is completely fenced and is still very active. A flagpole is situated near the center of the cemetery and about its base are stones representing the cemetery, the citizens of Brunswick, Elks, American Legion and Knights of Columbus. A maintenance building is located off Pine Street and the Ste. Marie family crypt is located near the center of the cemetery.

This record of St. John the Baptist Cemetery is dedicated to Judy Souther, the sextant of St. John the Baptist Church and caretaker of this cemetery, in recognition of the improvements she is making to these hallowed grounds as well as the valuable assistance she provided in connection to this record.

Contents

Volume 1 of 3 (Range 1 through 8)

- 1) Map illustrating the general arrangement of the cemetery.
- 2) Maps indicating the numbering of the ranges and detail maps.
- 3) Detail maps indicating the placement of the individual stones and markers by range.
- 4) Record of each individual stones inscription.

Volume 2 of 3 (Range 9 through 17)

- 5) Detail maps indicating the placement of the individual stones and markers by range.
- 6) Record of each individual stones inscription.

Volume 3 of 3 (Range 18 through 20)

- 7) Detail maps indicating the placement of the individual stones and markers by range.
- 8) Record of each individual stones inscription.
- 9) Additional cemetery burials.
- 10) Translations
- 11) Index by family name giving the location in the cemetery corresponding to the maps and text.

Note

Numbering of the markers is only as an aid in locating the stone within the context of this survey and do not represent any town or cemetery association designation.

Detail maps indicate monuments and marker stones by a dark outline. A double line indicates the side on which the marker stone or monument is inscribed. No double line indicates that the inscription is on the top surface of the stone.

Type of marker, be it Marble, Granite, Metal or Concrete is indicated on the detail maps for the cemetery. M = Marble, G = Granite, Mtl. = Metal, Conc. = Concrete.

This record of St. John the Baptist Cemetery was produced by Donald Cheetham of Brunswick, Maine and Mark Cheetham of Richmond, Maine 2007 - 2009.

ST. JOHN THE BAPTIST CEMETERY - Range Layout

RANGE #18

Map #1

N O R T H

A
C
C
E
S
S
R
O
A
D
W
E
S
T

E
A
S
T

G 35
Labbe

Labbe
G 34

McDermott
G 36

Laffely
G 37

Labbe
G 30

Atkins
24
Mtl.

Atkins
25
Mtl.

Karkos
G 31

Closson
G [REDACTED]
Pelletier
G 28

Potvin
G [REDACTED]

Bourgoin
G 22

Atkins
G 23

Pelletier
G 26

Pelletier
G 27

Ouellette
G 29
Ouellette
G 21

Allard
G 8

Mtl. Doiron
9

Beaudoin
G 10

Langlais
G 11

Langlais
G 12

Ducharme
G 13

Langlais
G 14

Lyon
G 16

Beaulieu
G 15

Toothaker
Mtl. 6

Coulombe
G 19

Ouellette
G 18

Ouellette
G 17

Ouellette
G 20

Pinette
G 1

Pepin
G 2

Lavoie
G 3

Strange
G 4

Toothaker
G [REDACTED]

Ouellette
G 7

A C C E S S R O A D

S O U T H

ST. JOHN THE BAPTIST CEMETERY - Range Layout

RANGE #18
Map #2

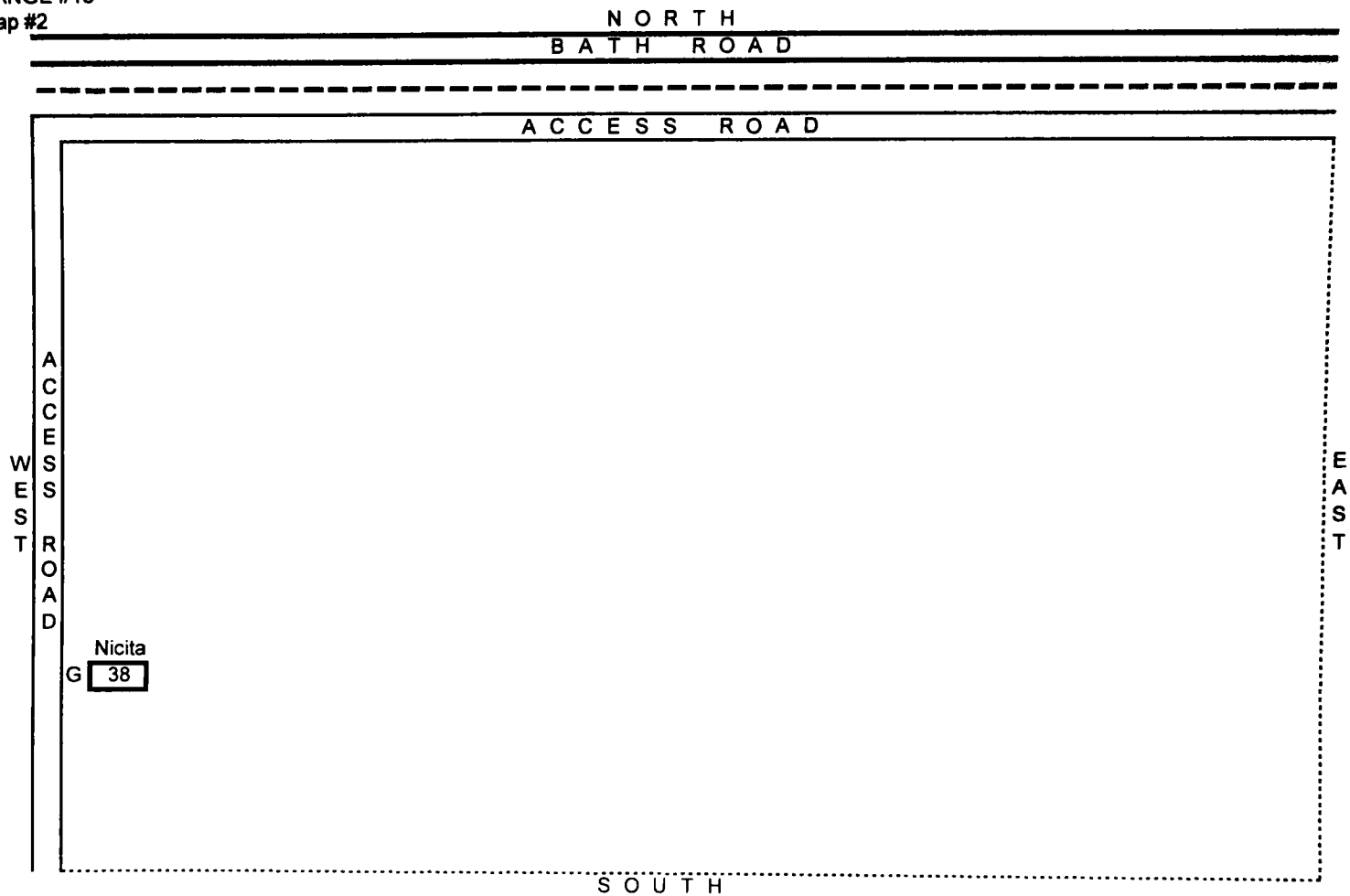

ST. JOHN THE BAPTIST CEMETERY - Range Layout

RANGE #18
Map #3

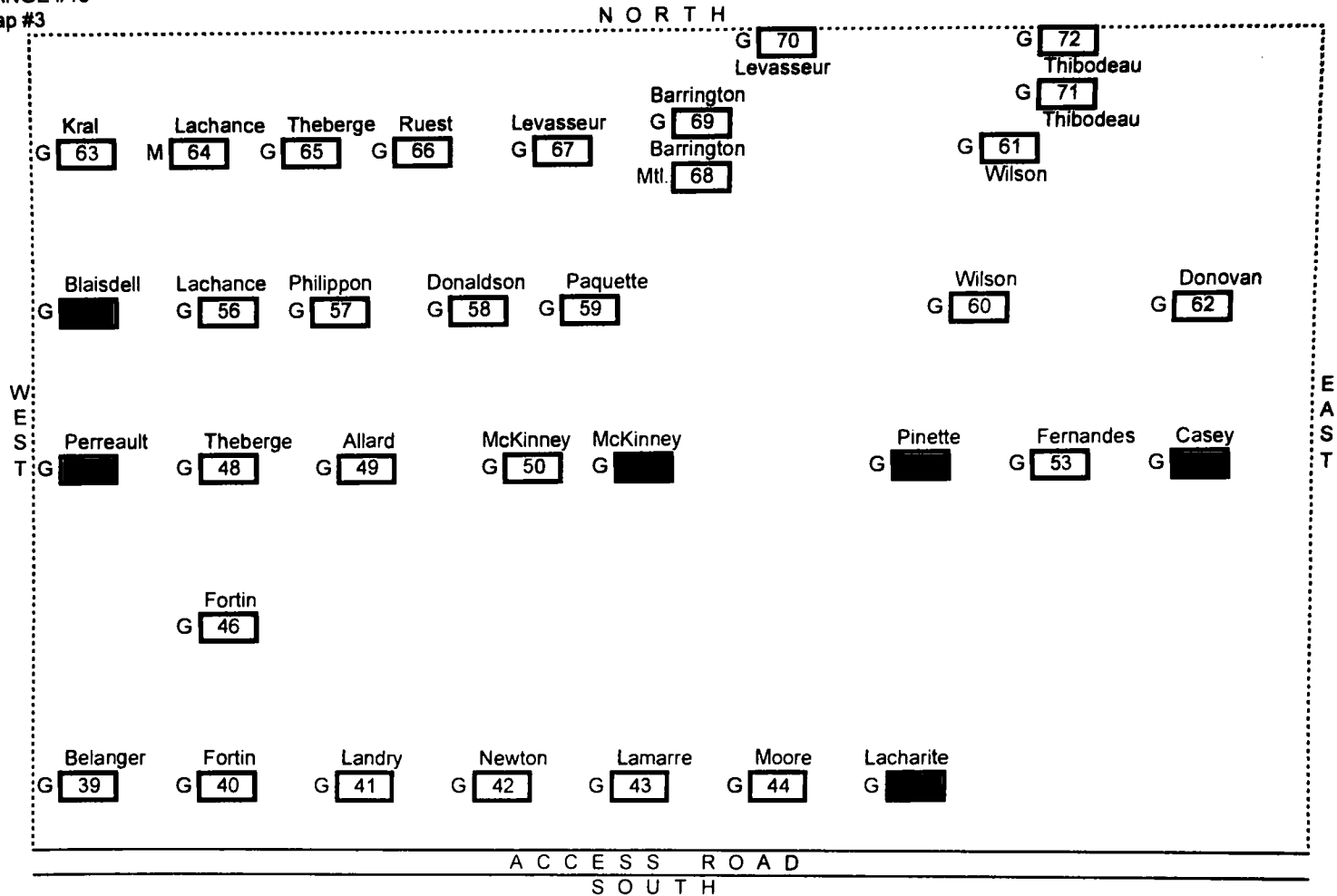

ST. JOHN THE BAPTIST CEMETERY - Range Layout

RANGE #18

Map #4

N O R T H
B A T H R O A D

A C C E S S R O A D

W
E
S
T

E
A
S
T

Tessier
G **82**

Marino
G **79**

Letourneau
G **76**

Mertz
G **77**

Marino
G **78**

Ward
G **80**

Morin
G **81**

Helie
G **73**

Lewis
G **74**

Zazeski
G **[REDACTED]**

S O U T H

ST. JOHN THE BAPTIST CEMETERY - Range Layout

RANGE #18

Map #5

N O R T H

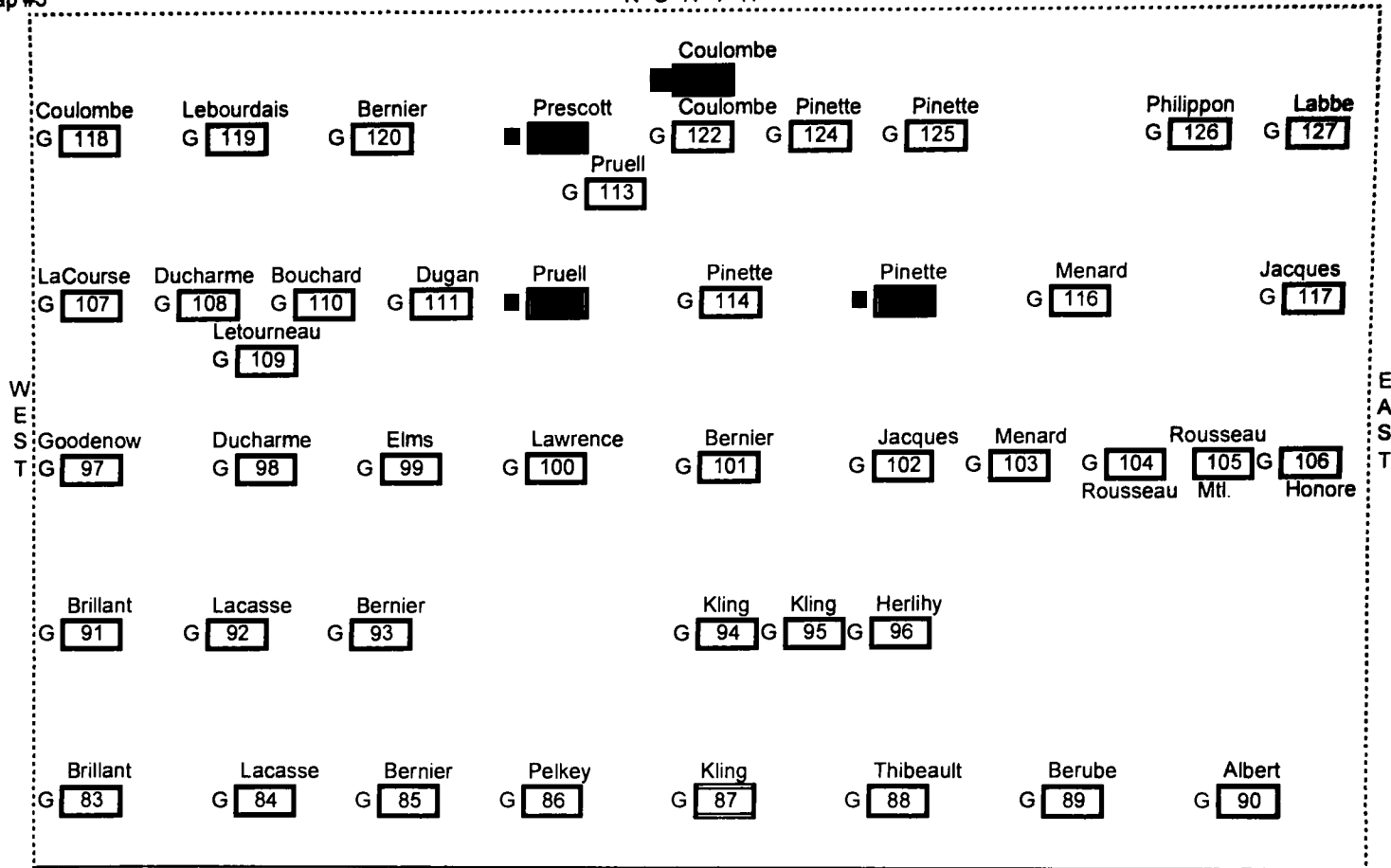

A C C E S S R O A D

S O U T H

ST. JOHN THE BAPTIST CEMETERY - Range Layout

RANGE #18
Map #6

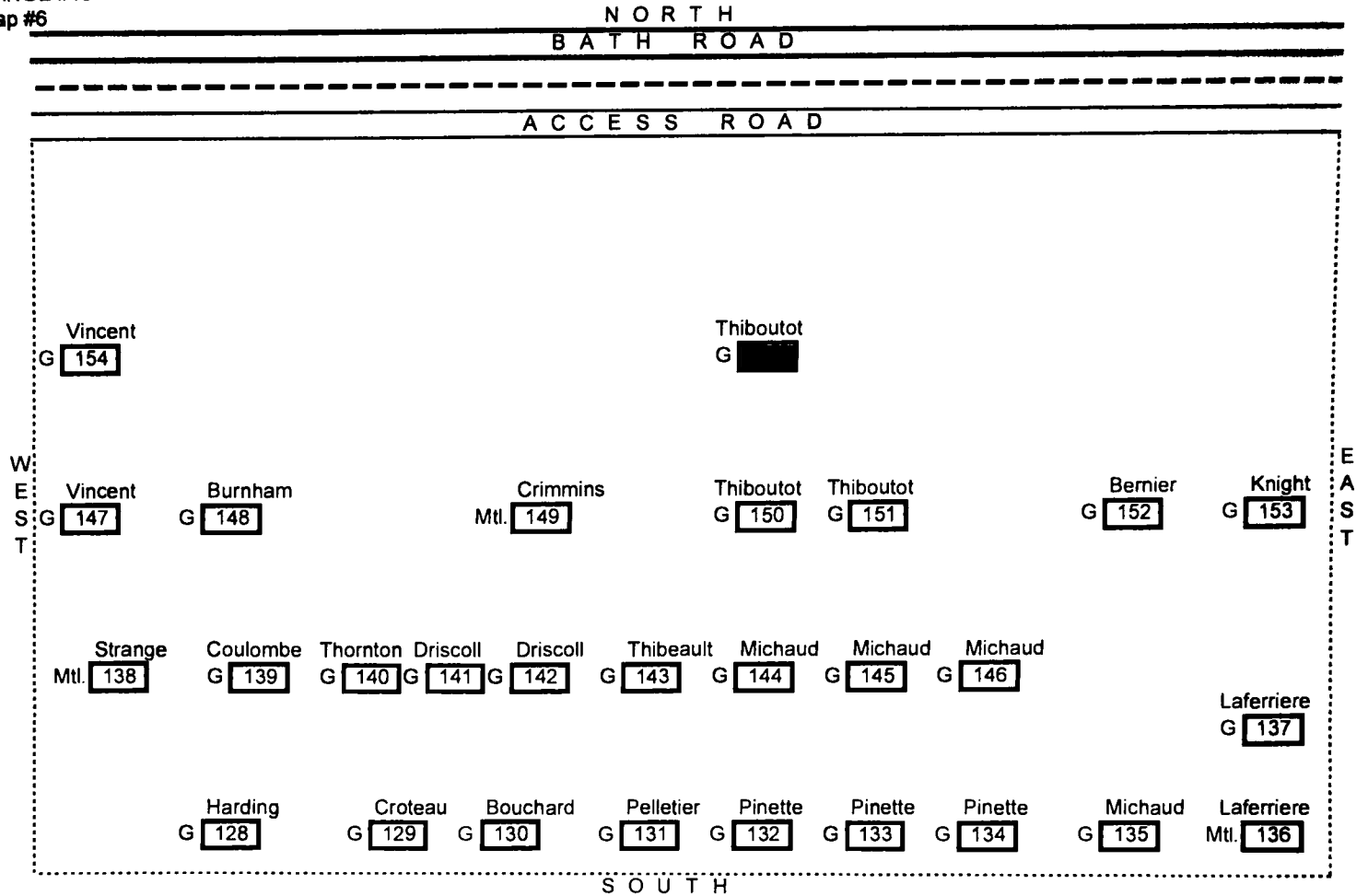

ST. JOHN THE BAPTIST CEMETERY - Range Layout

RANGE #18
Map #7

N O R T H

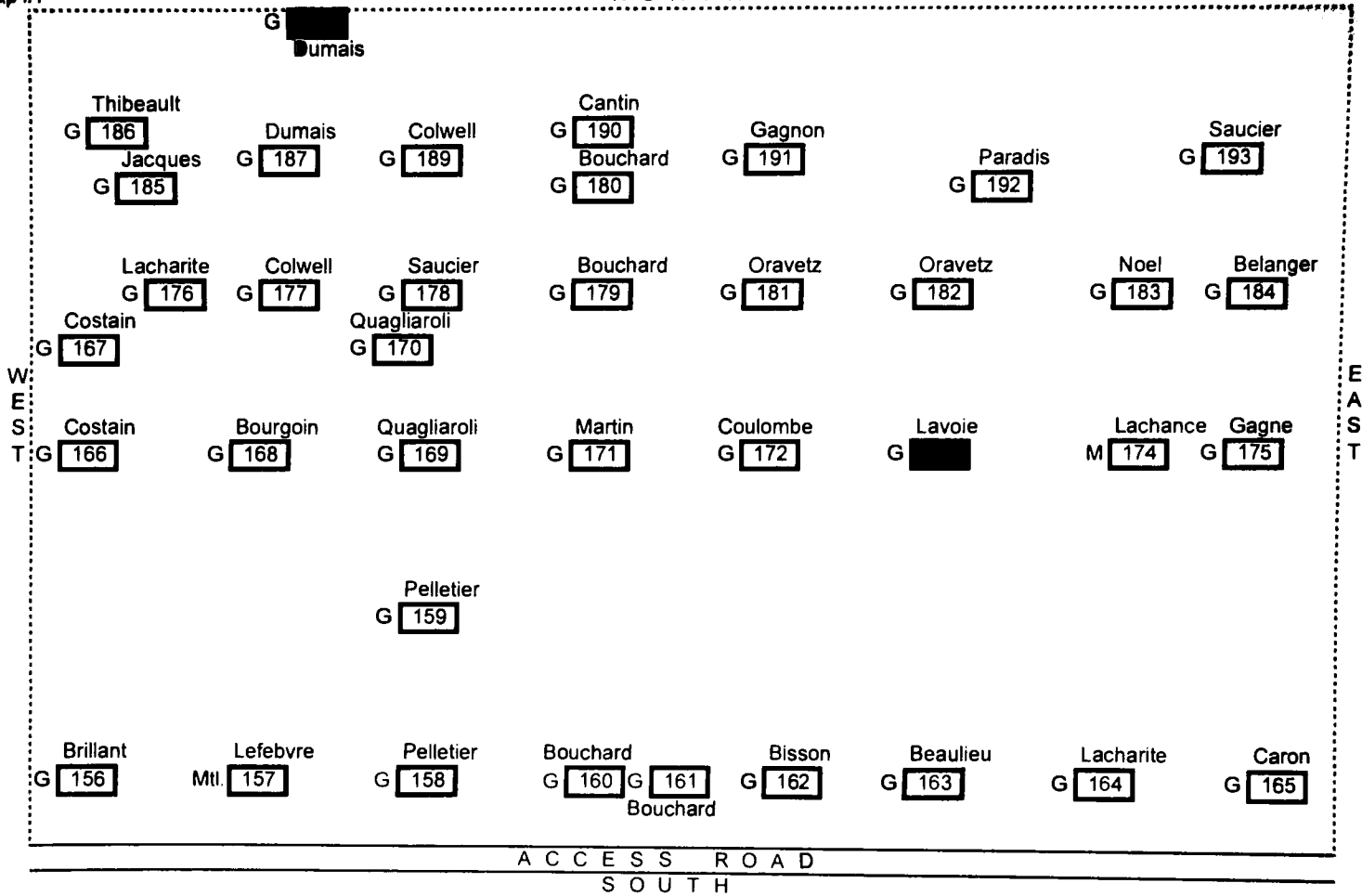

ST. JOHN THE BAPTIST CEMETERY - Range Layout

RANGE #18
Map #8

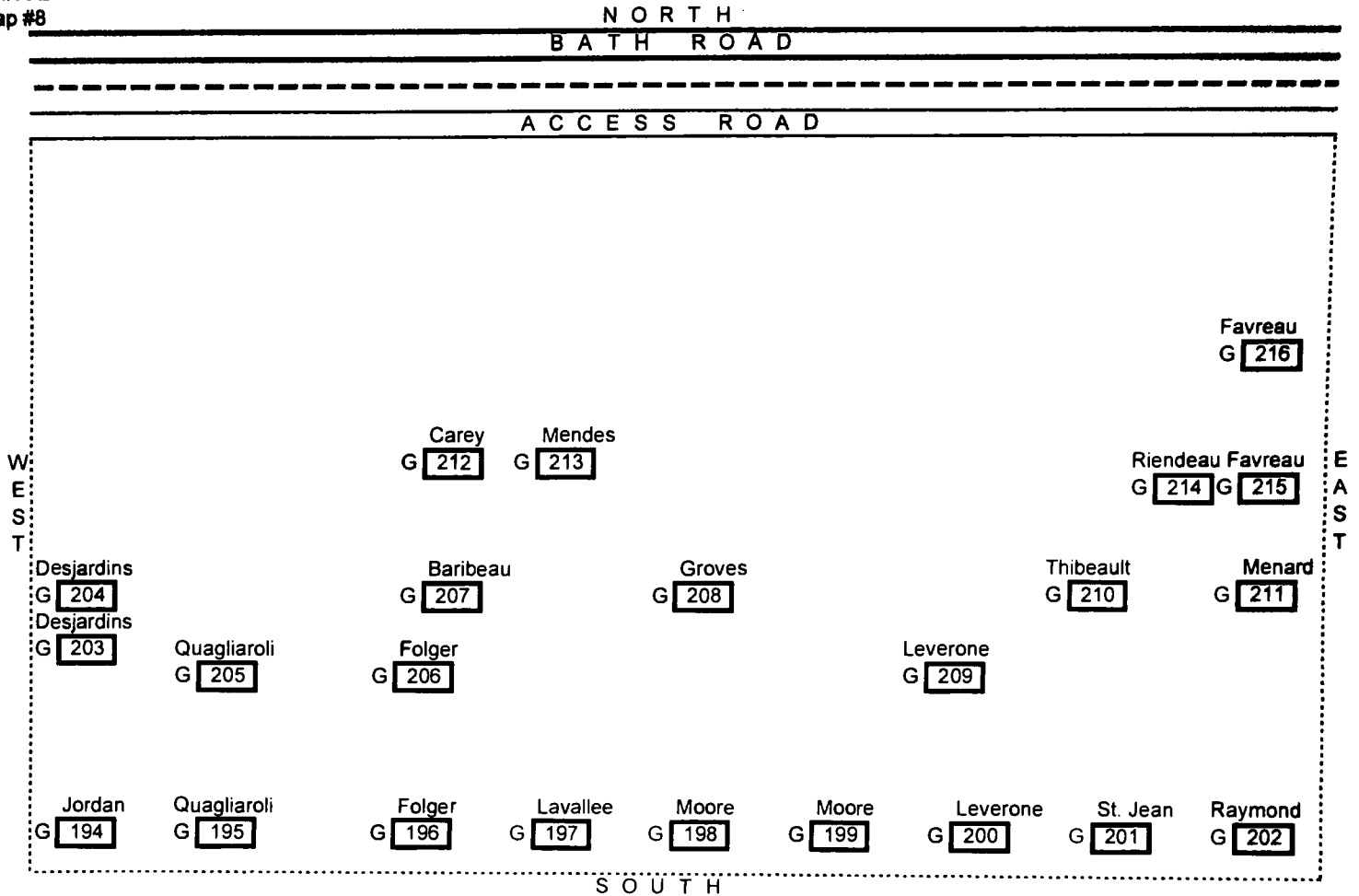

ST. JOHN THE BAPTIST CEMETERY - Range Layout

RANGE #18

Map #9

N O R T H

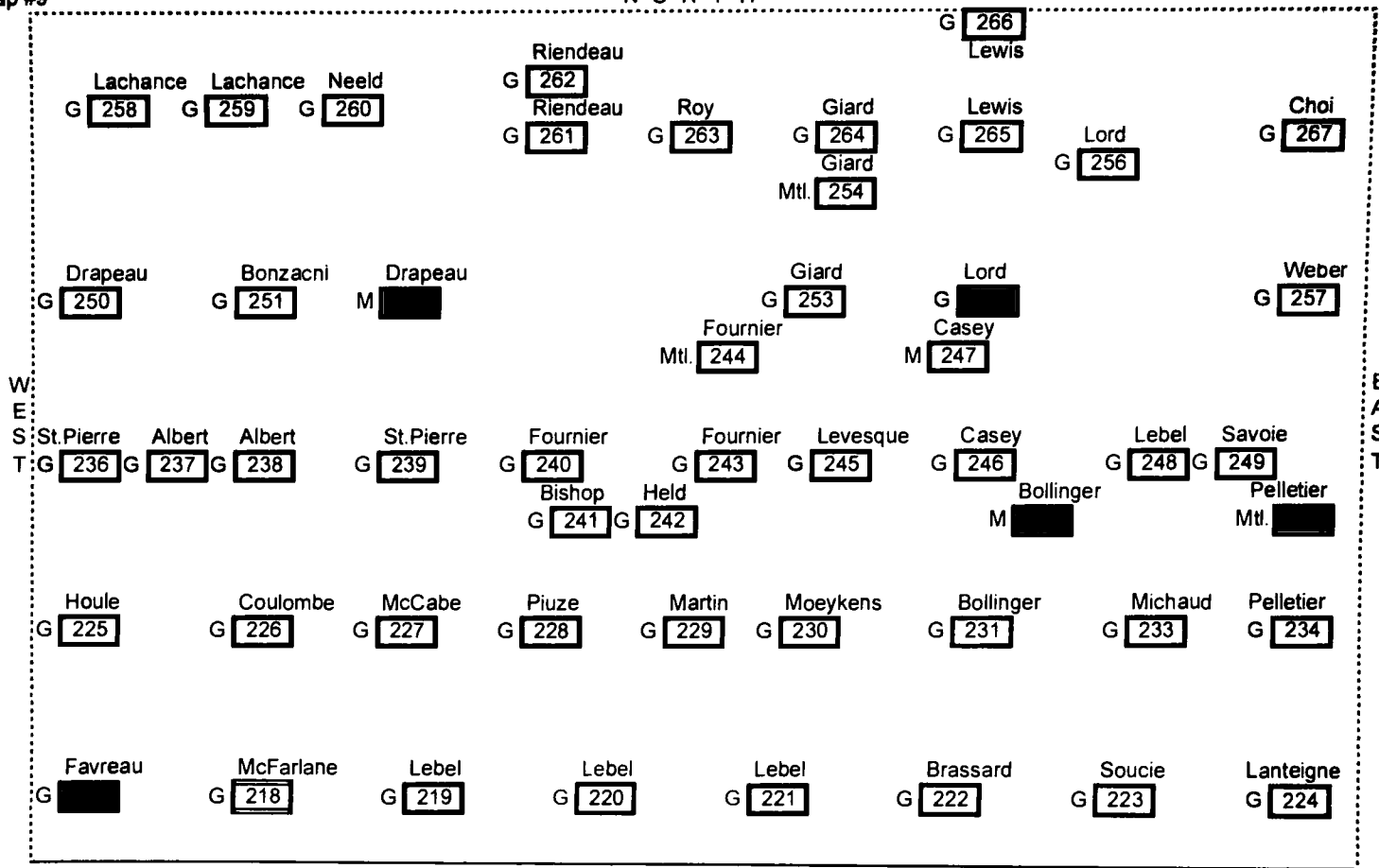

A C C E S S R O A D
S O U T H

ST. JOHN THE BAPTIST CEMETERY - Range Layout

RANGE #18

Map #10

N O R T H

B A T H R O A D

A C C E S S R O A D

W
E
S
T

E
A
S
T

Bollinger
Mtl. **279**

Bollinger
G **278**

Thiboutot
G **280**

Coffin
G **281**

Pelletier
G **282**

Tremblay
G **283**

Nutt
G **284**

Leavitt
G **285**

St. Pierre
G **276**

Davis
G **268**

O'Toole
G **269**

Yates
G **270**

Bramsen
G **271**

Stupinski
G **272**

Nolan
G **[REDACTED]**

Murillo
G **[REDACTED]**

St. Pierre
G **275**

Larrabee
G **[REDACTED]**

S O U T H

ST. JOHN THE BAPTIST CEMETERY - Range Layout

RANGE #18
Map #11

N O R T H

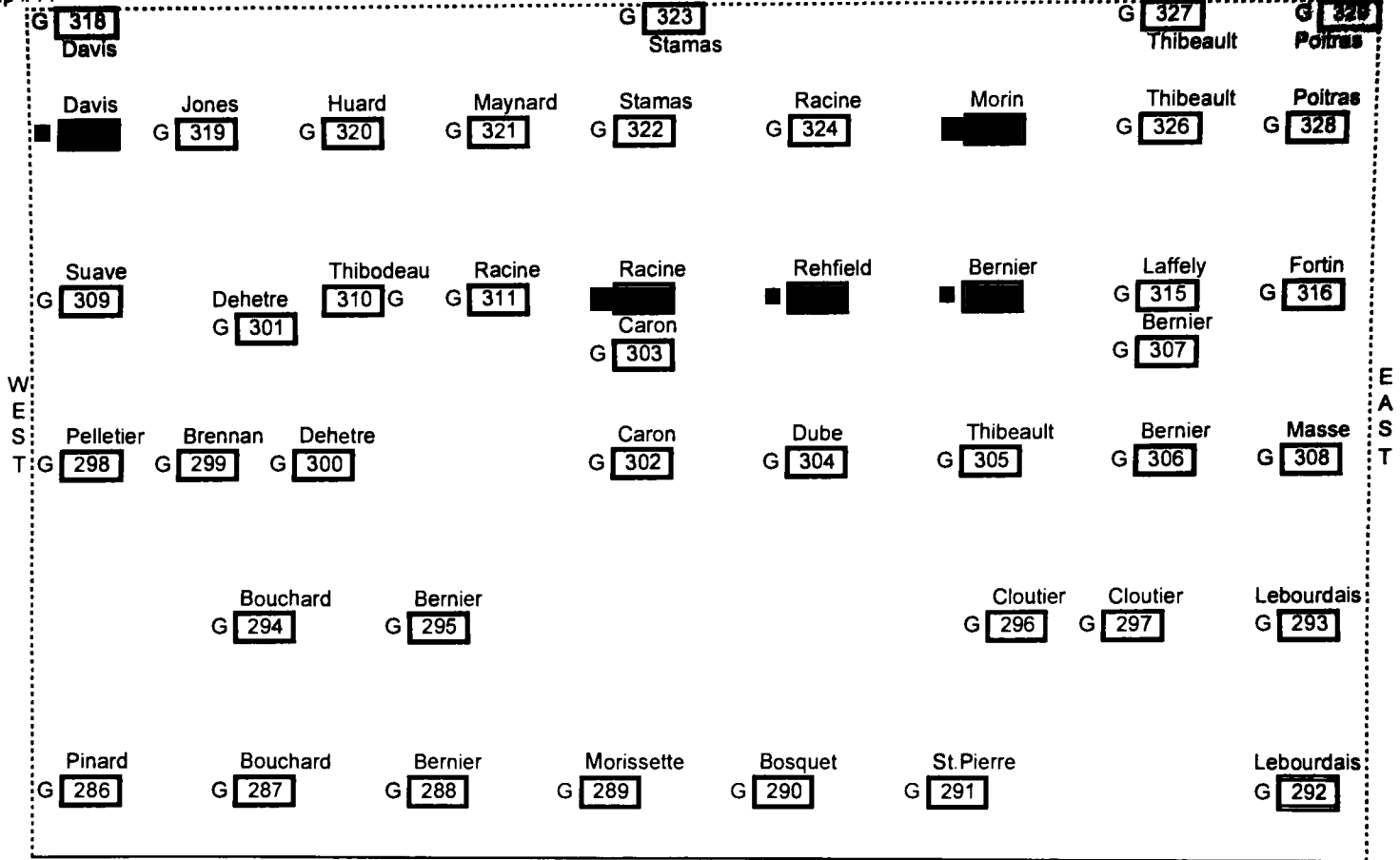

A C C E S S R O A D
S O U T H

ST. JOHN THE BAPTIST CEMETERY - Range Layout

RANGE #18
Map #12

N O R T H

B A T H R O A D

A C C E S S R O A D

W
E
S
T

E
A
S
T

Duval
G 344

Helie
G 340

Lavigne
G 341

Thibeault
G 342

Duval
G 343

Rodrigue
G 345

Stamas
G 346

Kenny
G 347

Rich
G 348

Rich
G 349

Hage
G 350

Reddy
G 351

Messier
G [REDACTED]

Brady
G [REDACTED]

Yacano
G 330

Messier
G 331

Desjardins
G 333

Fraser
G 334

Smart
G 336

Morneau
G 337

Livernois
G 338

Young
G 339

S O U T H

ST. JOHN THE BAPTIST CEMETERY - Range Layout

RANGE #18

Map #13

N O R T H

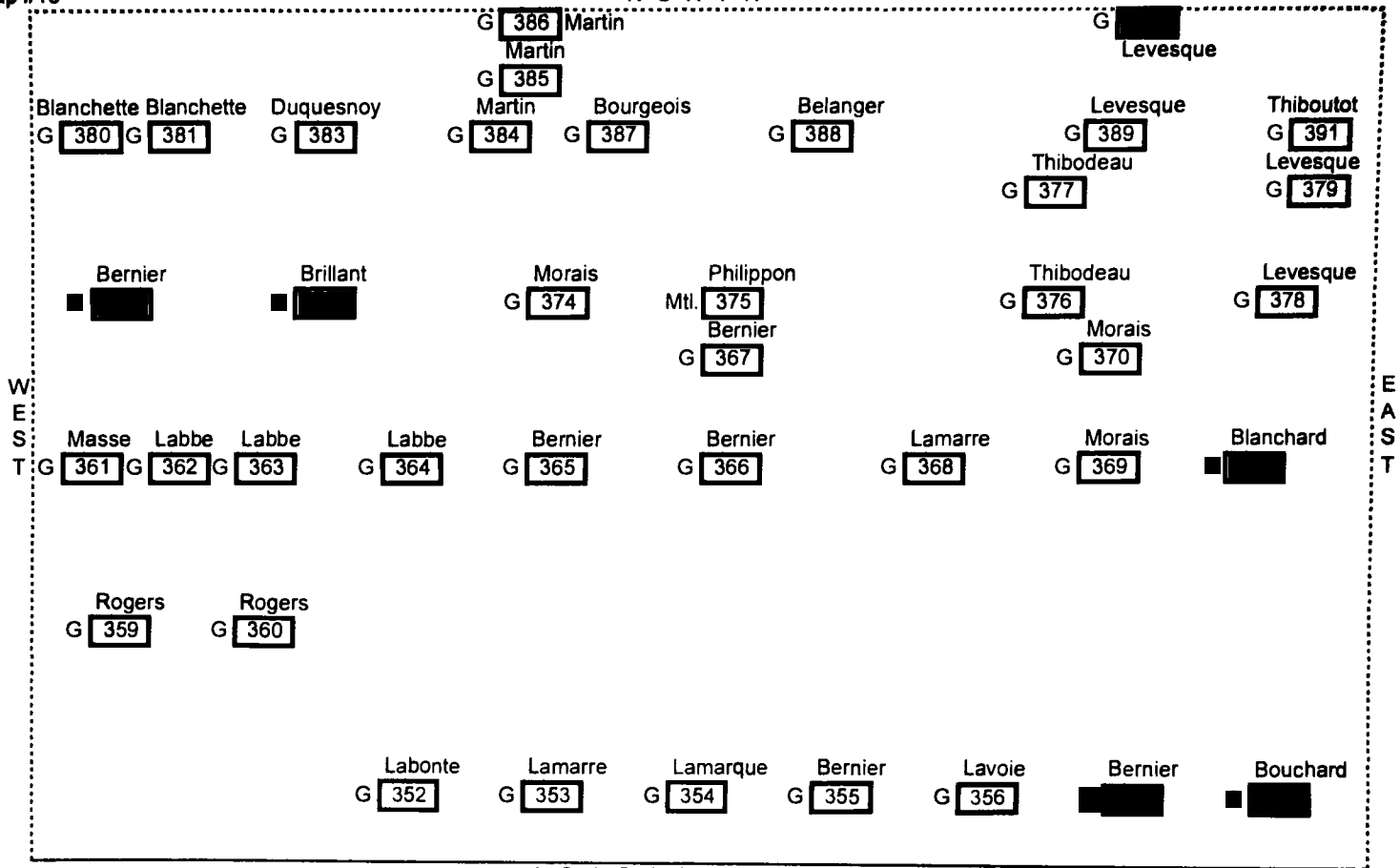

ST. JOHN THE BAPTIST CEMETERY - Range Layout

RANGE #18

Map #14

N O R T H

B A T H R O A D

A C C E S S R O A D

W
E
S
T

E
A
S
T

St. Pierre
G 406

G 400	G 401	G 402	G 403	G 404	G 405	G 407	G 408	G 409
Lucas	Wolfe	Wolfe	Mendes	St. Pierre	St. Pierre	Pratt	Dumont	Campbell
		Charron					Beaulieu	
		Mtl. 393					G 398	

G 382	G 392	G 394	G 395	G 396	G 397	G 399
Blanchette	Charron	Breton	Merritt	Kane	Beaulieu	Bolduc

S O U T H

ST. JOHN THE BAPTIST CEMETERY - Range Layout

RANGE #18

Map #15

N O R T H

W
E
S
T

E
A
S
T

Cloutier
G 428

Dauphin
Mtl. 429

Bernier
G 430

Stetson
■

Violette
G 424

Bernier
G 425

Riendeau
G 426

Dumais
■

Perez
G 419

Ouellette
G 420

Mosher
G 421

Morin
■

Chasse
G 416

Hughes
G 418

Thibeault
G 410

Morin
■

Gaudreau
G 412

Philippon
G 413

Chasse
G 414

Chasse
■

Radcliffe
■

A C C E S S R O A D
S O U T H

ST. JOHN THE BAPTIST CEMETERY - Range Layout

RANGE #18
Map #16

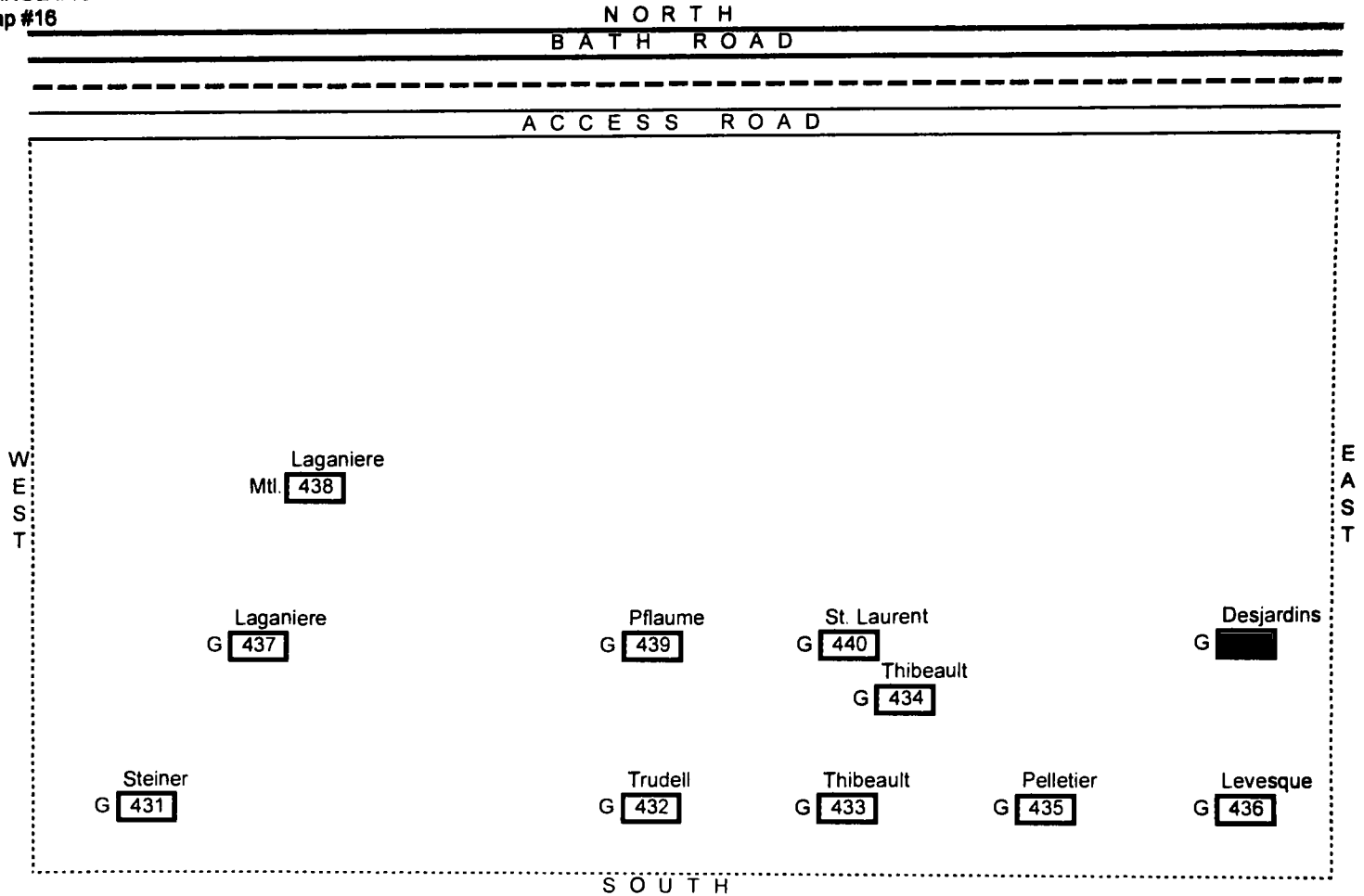

ST. JOHN THE BAPTIST CEMETERY - Range Layout

RANGE #18
Map #17

N O R T H

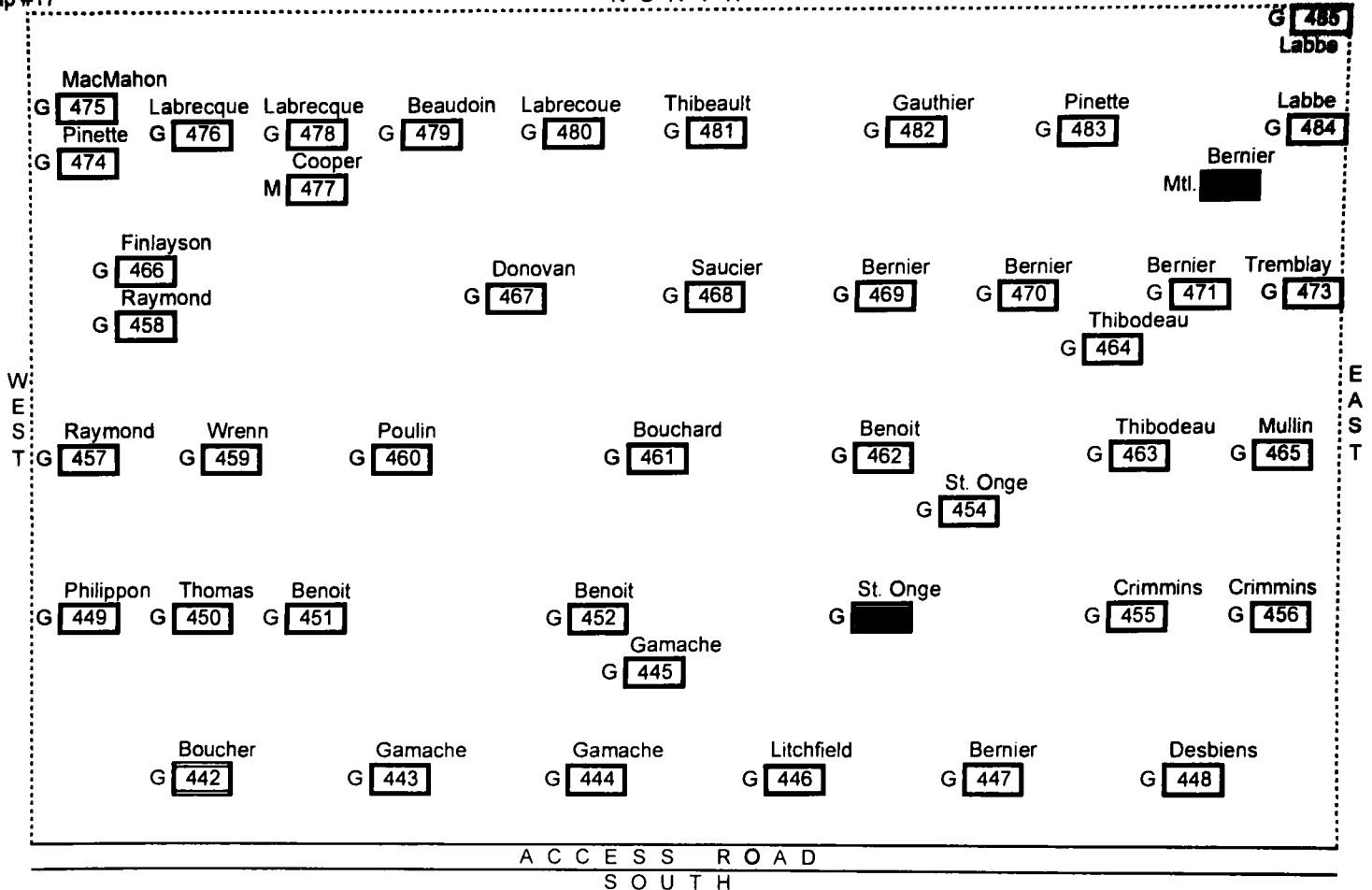

ST. JOHN THE BAPTIST CEMETERY - Range Layout

RANGE #18
Map #18

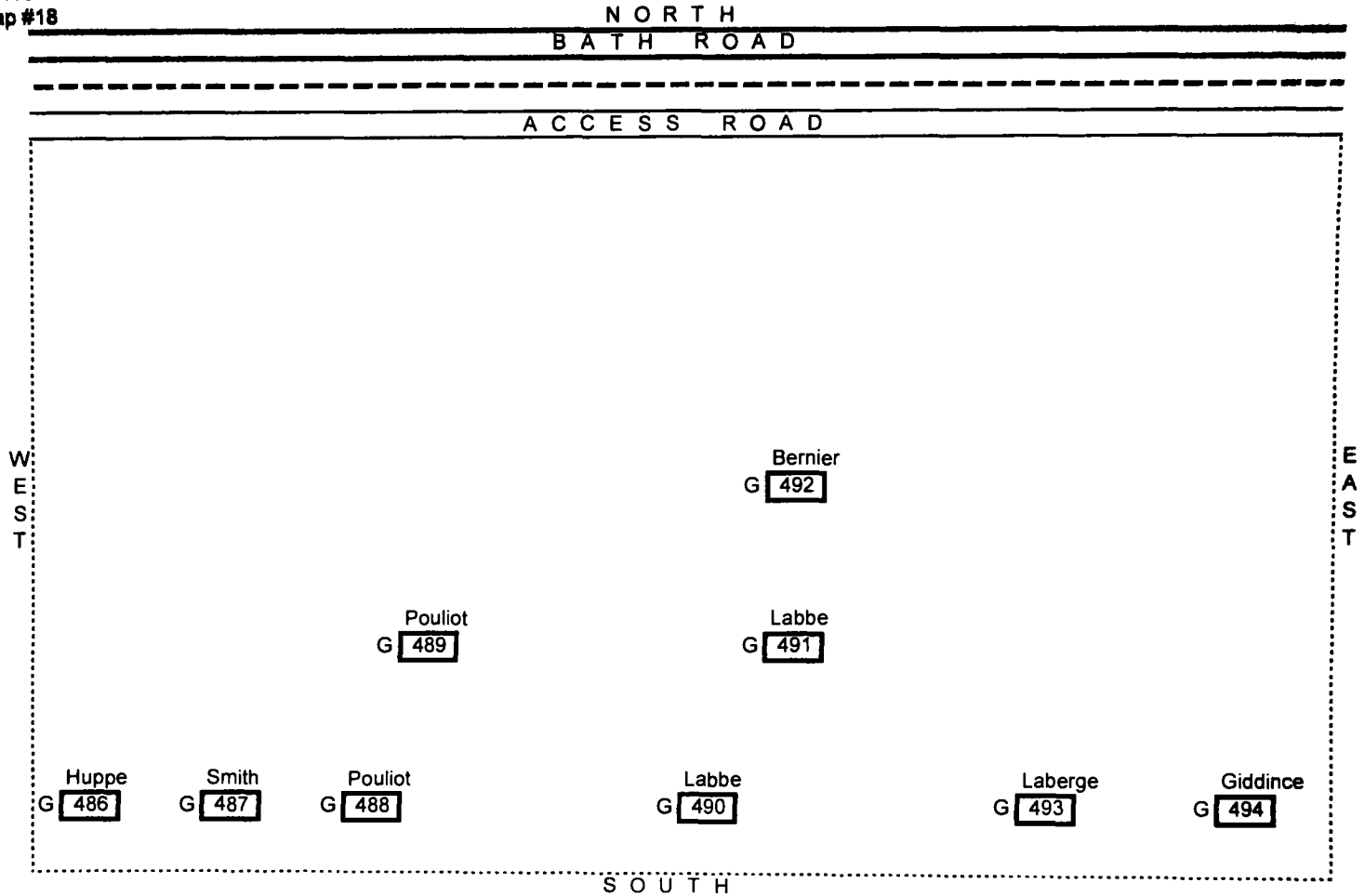

ST. JOHN THE BAPTIST CEMETERY - Range Layout

RANGE #18

Map #19

N O R T H

W
E
S
T

E
A
S
T

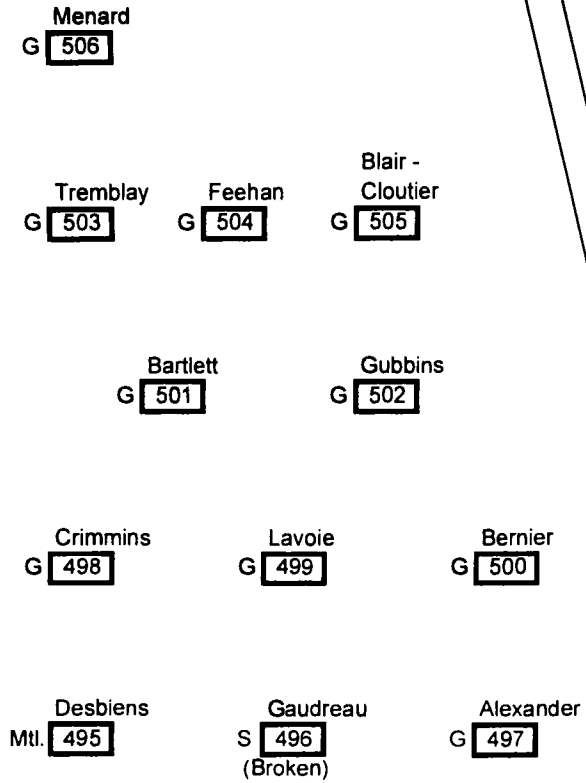

A C C E S S R O A D

S O U T H

ST. JOHN THE BAPTIST CEMETERY - Range Layout

RANGE #18

Map #20

N O R T H

B A T H R O A D

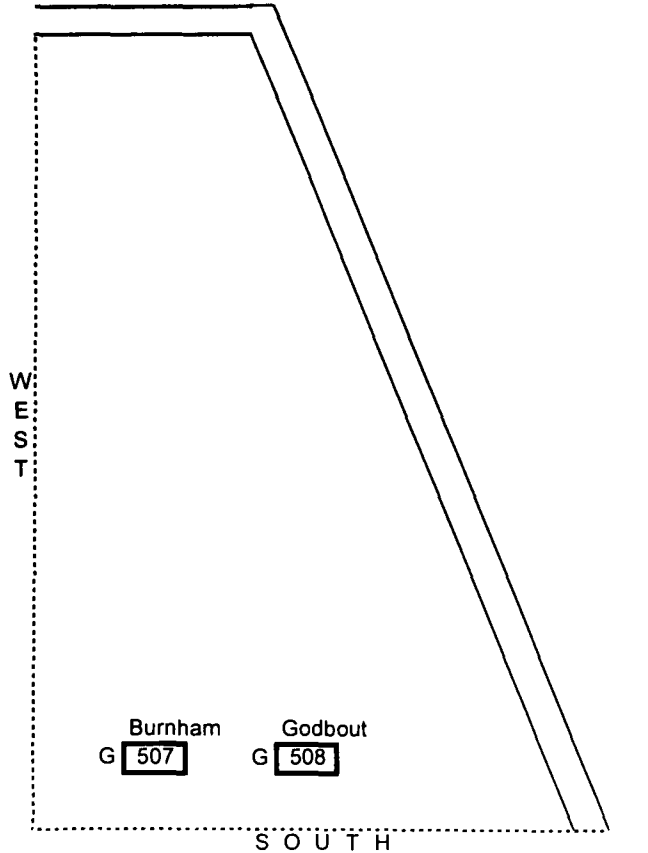

Burnham
G 507

Godbout
G 508

S O U T H

RANGE #18

- (R18#1) **ALPHONSE CECILE**
 1902 - 1977 1902 - 1986
PINETTE
- (R18#2) **PEPIN**
MARGARET O. LAURIER J. MARLENE Y.
 1907 - 1977 1912 - 1989 1933 - 2006
- (R18#3) **LAVOIE**
RAYMOND N. ROLANDE L.
 1926 - 1925 -
 Our Father Let us pray Hail Mary
 who art in heaven full of grace
- (R18#4) **MARY V. MALCOLM R.**
 Aug. 11, 1902 Sept. 28, 1902
 Feb. 19, 1976 Aug. 10, 1985
STRANGE
- (R18#5) **TOOTHAKER Sr.**
ROBERT ODETTE
 U.S. Navy Nurse
 1925 - 1980 1930 -
 In God's care
- (R18#6) **ROBERT V TOOTHAKER Sr**
 BM2 US Navy
 World War II
 1923 1980
- (R18#7) North Face:
 The Annunciation
- South Face:
OUELLETTE
ALBERT A.
 March 3, 1898 - May 31, 1976
 his wife
DIANA M. HARVEY
 March 9, 1902 - May 30, 1975
- (R18#8) **NORMAN E. ALLARD**
 June 2, 1947 - Feb. 20, 2005
LINDA D. ALLARD
 Sept. 30, 1945
- (R18#9) **VIOLET DOIRON**
 1925 2007
- (R18#10) **CONRAD R. BEAUDOIN**
 Dec. 26, 1931
ROBERTA JEAN BEAUDOIN
 Feb. 17, 1934 - Sept. 27, 2002
JOANNE M. BEAUDOIN
 June 9, 1954
- (R18#11) **LANGLAIS**
ISOLDE JOSEPH F. SONYA M.
 Feb. 8, 1934 June 10, 1928 Aug. 11, 1952
 Oct. 29, 1979
- (R18#12) **MADÉLINE M. LANGLAIS**
 Jesus Mary Joseph
 July 3, July 17,
 1924 2004
- (R18#13) **CECILE H. DUCHARME**
 Jesus Mary Joseph
 Oct. 1, Aug. 21,
 1917 1979

- (R18#14) LANGLAIS
 EDWARD P. DELINA
 Apr. 18, 1898 July 1, 1905
 May 31, 1992 Nov. 24, 1997
- (R18#15) BEAULIEU
 HERCULE L. EDNA T.
 Oct. 13, 1917 Apr. 17, 1914
 Apr. 20, 1997 Mar. 11, 1997
 Together
 forever
- (R18#16) MADELINE O. LYON
 May 26, 1934
 Dec. 23, 2005
- (R18#17) OUELLETTE
 ALBERT Z. DENISE R.
 July 28, 1929 May 30, 1931
 Aug. 17, 1994
- (R18#18) NEIL A. OUELLETTE
 May 2, Aug. 13,
 1954 2003
- (R18#19) 1900 HENRY J. COULOMBE 1979
 son epouse
 1902 ALIDA M. ALLARD 1986
 file
 1928 YOLANDE T. COULOMBE
- (R18#20) OUELLETTE
 MAURICE J. IRENE D.
 July 28, 1927 Jan. 2, 1933
 Nov. 23, 2003
- (R18#21) MAURICE J OUELLETTE
 US Navy
 World War II
 Jul 28 1927 Nov 23 2003
- (R18#22) BOURGOIN
 ALFRED C. EVELYN A.
 1909 - 1983 1915 - 1987
- (R18#23) ATKINS
 ALFRED L. Jr. ROSE M.
 Sept. 18, 1923 Aug. 10, 1925
 Jan. 23, 1994 Mar. 27, 1995
- (R18#24) ALFRED L ATKINS III
 US Navy
 Sep 27 1958 Jul 18 2006
- (R18#25) ALFRED L ATKINS
 BTG 3 US Navy
 World War II Korea
 Sep 18 1923 Jan 23 1994
- (R18#26) MAURICE W. PELLETIER
 Feb. 10, 1941
 Son of JOSEPH E. and JEANNETTE F.
- (R18#27) PELLETIER
 JEANNETTE F. JOSEPH E.
 1917 - 1983 1917 - 2000
- (R18#28) JOSEPH E PELLETIER
 PFC US Army
 World War II
 Feb 17 1917 Jun 7 2000

(R18#29)

OUELLETTE
RAYMOND L. PHYLLIS A.
1936 - 1981 1937 -

(R18#30)

LABBE
Husband Wife MARY
RAYMOND MADELINE RANDALL
1923 - 1991 1930 - 1906 - 1982

(R18#31)

KARKOS
PAUL CECILE E.
1910 - 1987 1918 - 1983

(R18#32)

CLOSSON
HERBERT G. ADRIENNE E.
Oct. 3, 1919 Feb. 22, 1920
Sept. 15, 1983

(R18#33)

POTVIN
LOUIS R. LEAH V.
1917 - 1984 1913

(R18#34)

Beloved wife & mother	LABBE	Beloved husband & father
PATRICIA A.	Beloved daughter	RAYMOND M.
Feb. 6, 1962	CHRISTINA M.	Sept. 23, 1959
	Nov. 13, 1984	Sept. 16, 2004
	July 27, 1986	

(R18#35)

"Our little angel"
CHRISTINA M. LABBE
November 13, 1984
July 27, 1986

(R18#36)

MARGARET E.
McDERMOTT
May 17, 1900
July 26, 1991

(R18#37)

PHILIPPE E. LAFFELY
Oct. 22, 1927 - Sept. 30, 2000
his wife
DORIS R. BOUTOT
June 11, 1932 -
In God's care

(R18#38)

CHARLES S. NICITA
Mar. 20, 1920 - June 15, 2005
FRANCES M. NICITA
Jan. 13, 1921

(R18#39)

BELANGER
NAPOLEON R. LUCILLE M.
1911 - 1974 1911 - 2000

(R18#40)

FORTIN
HENRY GERMAINE
1913 - 1974 1918 - 2001

(R18#41)

LANDRY
THERESE ARTHUR
1914 - 1975 1912 - 1970

(R18#42)

NEWTON
YVONNE M. BASIL G.
1910 - 1975 1914 - 2002

(R18#43)

LAMARRE
RUTH E. GERARD F.
Oct. 4, 1915 Apr. 7, 1912
July 27, 1977 Nov. 7, 1982

(R18#44)

MOORE
ROY W. VENISE L.
July 16, 1918 Mar. 12, 1920
May 22, 1975 Oct. 15, 2004

(R18#45)

LACHARITE
ALBERT H. NORA L.
1905 - 1975 1908 - 1994

(R18#46)

HENRY FORTIN
AM3 US Navy
Aug 22 1913 Oct 9 1974

(R18#47)

PERREAULT
LEO PAUL DONNA M.
1937 - 1979 1941 -
In loving memory

(R18#48)

THEBERGE
WILLIAM E. ROSALIE D.
1911 - 1979 1913 - 2003

(R18#49)

SARTO J. IRENE G.
1919 - 2005 1917 - 2002
ALLARD

(R18#50)

ARTHUR V McKINNEY
PFC US Army
World War II
May 1 1925 Aug 27 2003

(R18#51)

RICHARD A. McKINNEY
Nov. 20, 1946 - Mar. 17, 1979
What the heart has once owned
and had, it shall never lose
in God's care.

(R18#52)

PINETTE
RAYMOND A. ALVINE D.
1919 - 1978 1920 -

(R18#54)

CASEY
JOSEPH I. ADRIENNE L.
1901 - 1979 1905 - 1987

(R18#53)

AMELIA FERNANDES
May 20, April 23,
1898 1979

(R18#56)

LACHANCE
EDMOND FIDELIA M.
1896 - 1981 1899 - 1996

(R18#55)

PRISCILIA A. GUY E.
1928 - 1981 1932 -
BLAISDELL

(R18#57) PHILIPPON
IHS ROSARIO O. CECILE E.
1911 - 1993 1910 - 1998

(R18#58) MARY COLLETTA
DONALDSON
June 22, 1902
August 21, 1982

(R18#59) PAQUETTE
ADELARD HELENA
1900 - 1981 1907 - 1990

(R18#60) WILSON
ROBERT J. NOELLA M.
1926 - 1982 1928 - 1999

(R18#61) ROBERT JOSEPH WILSON
S1 US Navy
World War II
Dec 16 1926 Nov 18 1982

(R18#62) DONOVAN
GRATTON H. MARY AGNES
1909 - 1981 1913 - 1997

(R18#63) KRAL
EDWARD F. RELLA M.
1920 - 1984 1918 - 1997

(R18#64) EDMOND
LACHANCE
Pvt
US Army
World War I
Sep 13 1896
Jun 10 1981

(R18#65) THEBERGE
CHARLES J. CECILE T.
June 12, 1912 Apr. 19, 1938 Sept. 26, 1913
Feb. 4, 1989 Feb. 20, 2006

(Center date with two linked rings.)

(R18#66) RUEST
ALFRED DONALDA P.
1909 - 1990 1916 - 1984

(R18#67) DAVID L. GEORGIANNA
1904 - 1962 1909 - 1983
LEVASSEUR

(R18#68) MARION H BARRINGTON
PO1 US Navy
World War II
Jan 28 1926 May 7 2002

(R18#69) BARRINGTON
MARY LOU MARION "Pappy"
Nov. 23, 1921 Jan. 28, 1926
Jan. 31, 1984 May 7, 2002

(R18#70)	<p>DAVID L. LEVASSEUR Aug. 12, Nov. 6, 1904 1962 Husband of GEORGIANA LABBE</p>	(R18#71)	<p>MARCELLA M THIBODEAU beloved wife of VERNON N THIBODEAU Nov 4 1919 Aug 29 2001</p>
(R18#72)	<p>VERNON N THIBODEAU PFC US Army World War II Oct 20 1916 May 9 1985</p>	(R18#73)	<p>HELIE MAURICE I. MURIEL J. Aug. 11, 1925 Mar. 13, 1924 Apr. 21, 1999 Sept. 18, 2003</p>
(R18#74)	<p>GUY E LEWIS Jr PFC US Army World War II Mar 20 1922 Mar 31 2003</p>	(R18#75)	<p>ZAZESKI DORIS M. June 19, 1939 April 14, 1999</p>
(R18#76)	<p>M. CAROLINE LETOURNEAU June 12, July 26, 1925 2006 "Forever loved"</p>	(R18#77)	<p>MERTZ RONALD PATRICIA O'MEARA Apr. 27, 1940 Apr. 15, 1943 May 6, 2007</p>
(R18#78)	<p>MARINO BENITO J. Nov. 6, 1925 Nov. 27, 2005</p>	(R18#79)	<p>BENITO J MARINO US Navy Nov 6 1925 Nov 27 2005</p>
(R18#80)	<p>In loving memory Mother Father ANNA M. WARD EDWARD WARD June 30, 1924 Together June 20, 1924 Oct. 15, 2005 forever</p>	(R18#81)	<p>GERALD R. MORIN July 19 Oct. 17 1952 1999</p>
	(R18#82)		<p>HERVEY A TESSIER Cpl US Marine Corps World War II Aug 9 1922 Oct 1 2006</p>

(R18#83) BRILLANT
ROMAIN LUCILLE R.
Nov. 8, 1924 July 9, 1921
Dec. 16, 2004

(R18#84) LACASSE
HENRY A. YOLANDE M.
1912 - 1975 1919 - 1995

(R18#85) ALFREDA M. BERNIER
1903 - 1981

(R18#86) PELKEY
PATRICK RHEA M.
Aug. 3, 1915 July 2, 1939
Mar. 22, 2006

(R18#87) South Face:

KLING
WALTER L.
Feb. 5, 1896 May 19, 1984
his wife
MARION ALEXANDER
July 7, 1893 Mar. 11, 1983
their daughter
CONSTANCE K. HERLIHY
Aug. 12, 1924
their son
DAVID P. HERLIHY
Dec. 2, 1960 May 4, 1982

(R18#88) THIBEAULT
EUGENE H. Sr. HELENA
1901 - 1974 1897 - 1980
Jesus Marie Joseph

North Face:

The Resurrection

(R18#89) The rose still blooms
Married June 15, 1940
Husband Wife
IRENEE J. BERUBE ANITA NORMAND BERUBE
Nov. 21, 1906 Mar. 12, 1914
Aug. 18, 2000 July 11, 1994

(R18#90) ALBERT
ROBERT A. ROLLANDE N.
1913 - 1984 1916 - 2007

(R18#91) ROMAIN BRILLANT
YN3 US Navy
World War II
Nov 8 1924 Dec 16 2004

(R18#92) HENRY A LACASSE
MM3 US Navy
World War II
1912 1975

(R18#93) ANDREW E BERNIER
PFC US Army
World War II
Nov 9 1924 Sep 1 2000

(R18#94) MARION R. KLING
1893 - 1983

(R18#95) WALTER L. KLING
1896 - 1984

(R18#96) DAVID P. HERLIHY
1960 - 1982

(R18#97) GOODENOW
MARIE A. ERNEST C.
1928 - 1978 1923 -

(R18#98) DUCHARME
YVETTE R. RAYMOND J.
Jan. 1, 1920 Sept. 25, 1919
Oct. 19, 1978 Aug. 23, 1994

(R18#99) ELMS
WILLIAM E. FLORENCE E.
Mar. 25, 1909 June 23, 1912
Jan. 5, 1980 Dec. 21, 2005

(R18#100) LAWRENCE
A. JACK ALICE A.
1898 - 1978 1899 - 1978

(R18#101) C. BERNIER
CALIXTE CELENDIA RAYMOND
1903 - 1984 1901 - 1994 1931 - 1985

(R18#102) JACQUES
In loving memory
EDMOND R. SUZANNE J.
1943 - 1978 1943 -

(R18#103) MENARD
ODILAS YVONNE
1899 - 1985 1904 - 1996

(R18#104) ANNE - MARIE
DRAPEAU ROUSSEAU
1903 -

(R18#105) JOSEPH H ROUSSEAU Jr
Maine
Colonel US Army
World War I & II
Class of 1920 USMA
April 5 1899 March 29 1969

(R18#106) JOSEPH HONORE III
PETER
1932 - 1945

(R18#107) MITCHELL D. RENA R.
1907 - 1981 1905 - 1993
LaCOURSE

(R18#108) RAYMOND J DUCHARME
1st Lt US Army
World War II Korea
Sep 25 1919 Aug 23 1994

(R18#109) LETOURNEAU
1911 DORIA LETOURNEAU 1982
his wife
1914 ADRIENNE M. COUTURE 1981

(R18#110) BOUCHARD
JOSEPH A. LOUISE J.
1919 - 1981 1928 - 2002

(R18#111) Mother
CHARLOTTE B. DUGAN
1917 - 1980

(R18#112) JOHN J. Jr. JOSEPHINE M.
1919 - 1980 1922
PRUELL

(R18#113) JOHN J PRUELL Jr
PFC US Army
World War II
1919 1980

(R18#114) PINETTE
MARY J.
Aug. 31, 1944

RICHARD F.
Sept. 5, 1981
Dec. 21, 1938
June 19, 2001

(Note: 2 linked rings over center date.)

(R18#115) PINETTE
LAURIER A. VIRGINIA R.
1912 - 2005 1913 - 2004

(R18#116) GERARD O. VALENCIA L.
1926 - 1927 -
MENARD

(R18#117) JACQUES
RAYMOND E. SOLANGE M. GERARD F.
Jan. 2, 1918 June 2, 1918 May 14, 1956
Feb. 5, 1996 Aug. 13, 2005

(R18#118) COULOMBE (R18#119) LEBOURDAIS
HARVEY J. SIMONNE B. GEORGE L. ALMINA
Mar. 22, 1909 Mar. 11, 1910 1894 - 1987 1900 - 1987
Mar. 17, 1985 June 27, 1999

(R18#120) BERNIER
ROBERT J. THERESA F. (Note: 2 linked rings over
Jan. 12, 1929 Feb. 2, 1952 Nov. 16, 1929 center date.)
Jan. 29, 2006

(R18#121) PRESCOTT
Our beloved daughter
KRISTEN R.
1977 - 1985

(R18#122)

COULOMBE
DAVID J. CHRISTINA J.
May 25, 1957 July 20, 1951

(R18#123)

Their son
ROGER J.
Apr. 5, Sept. 24,
1984 1984

(R18#124)

RICHARD F PINETTE
US Marine Corps
Dec 31 1938 Jun 19 2001

(R18#125)

PINETTE
KENNETH B.
Dec. 8, 1936 Nov. 19, 1955
Aug. 19, 2006

SHIRLEY E.
Apr. 24, 1935
Dec. 21, 2000

(Note: 2 linked rings over
center date.)

(R18#126)

PHILIPPON
ROMEO J. CORDELIA
1904 - 1984 1907 - 1999

(R18#127)

LABBE
LOUIS A. Married ANNIE S.
1895 - 1985 June 5, 1895 - 1984
1916

(R18#128)

JEANNETTE H. HARDING
May 14, 1933
June 27, 1989
Our loving mother

(R18#129)

CROTEAU
PAUL A. SIMONNE A.
1937 - 1999 1937

(R18#130)

MARCEL N. BOUCHARD
Aug. 30, 1929
Nov. 4, 1989

(R18#131)

PELLETIER
GEORGE J. DORIS C.
Feb. 20, 1926 Jan. 6, 1928
Mar. 5, 1987 Oct. 11, 1985

(R18#132)

DAVID I. PINETTE
Aug. 24, 1919

(R18#133)

GLORIA C. PINETTE
June 29, 1926
Sept. 18, 1987

(R18#134)

PINETTE
ROBERT M.
1915 2005

(R18#135)

MICHAUD
J. ADRIEN M. CLAIRE
July 30, 1920 Dec. 2, 1920
July 19, 2004

(R18#136) ROLAND F. MEY A.
1931 - 2007 1934 -
LAFERRIERE

(R18#137) ROLAND F LAFERRIERE
SSgt US Marine Corps
Korea Vietnam
Nov 29 1931 Aug 21 2007
Purple Heart

(R18#138) WILLIAM D STRANGE
1933 2007

(R18#140) THORNTON
JEANNETTE A. JOHN P.
Jan. 22, 1918 Sept. 15, 1950
Oct. 4, 2006 Nov. 14, 2000

(R18#139) GERARD R. COULOMBE
July 2, 1922 - June 28, 2002

(R18#141) MURIEL D. DRISCOLL
Beloved wife of
JAMES R. DRISCOLL
June 18, 1924 - Nov. 12, 2007

(R18#142) JAMES R. DRISCOLL
RM1 US Navy
WWII Korea
Oct. 1, 1921 - Mar. 23, 2003

(R18#144) DAVID T. MICHAUD Sr.
April 10, 1935

(R8#143) ROGER M. THIBEAULT
Nov. 17, 1933 Oct. 16, 2000
his wife
MARION E. THIBEAULT
Nov. 30, 1933

(R18#145) ANITA M. MICHAUD
January 2, 1935

(R18#146) DAVID T. MICHAUD Jr.
November 7, 1959
October 8, 2000

(R18#147) VINCENT
HENRI LEON DORIS DUPERRÉ
Apr. 1, 1914 May 31, 1928
May 14, 2005

(R18#149) THOMAS E CRIMMINS
Maj US Army
Aug 5 1945 Mar 5 2003

(R18#148) BURNHAM
ROBERT G. MARK T. FLORENCE E.
Apr. 22, 1921 Dec. 6, 1958 Oct. 29, 1918
Dec. 25, 2003 Apr. 3, 2006

(R18#150) THIBOUTOT
HENRY G. LOUISE C.
Apr. 10, 1936 Feb. 13, 1937
May 25, 2007 Feb. 22, 2003

(R18#151) ROBERT O. THIBOUTOT Sr.
August 11, 1917
January 1, 2004

(R18#152) **MARTHA H. BERNIER**
December 26, 1910
July 5, 2003
In God's care.

(R18#153) **KNIGHT**
So much in love
RICHARD A. **ALINE ARLENE A.** (Note: 2 linked rings
Dec. 31, 1938 Dec. 12, 1964 Mar. 26, 1939 above center date.)
July 30, 2001
Last journey home

(R18#154) **HENRI L VINCENT** (R18#155) **HENRY G THIBOUTOT**
SSgt US Army Cpl US Marine Corps
World War II Korea
1914 2005 Apr 10 1936 May 25 2007

(R18#156) **ADRIEN E.** **ALICE A.**
April 13, 1913 **BRILLANT** July 30, 1915
March 7, 1995 Jesus Marie Joseph Dec. 14, 1974

(R18#157) **MARY LAFEBVRE** (R18#158) **PELLETIER**
1915 - 1974 Husband Wife
ALCIDE F. **CECILE G.**
1916 - 1975 1922 -
In loving memory

(R18#160) **BOUCHARD**
JOSEPH MAURICE **CLARA JO**
1935 1945
(R18#159) **ALCIDE F PELLETIER**
Tec 4 US Army
Nov 21 1916 Jan 22 1975

(R18#161) **BOUCHARD**
WILLIAM E. **SOPHIE**
1905 - 1986 1910 - 1997

(R18#162) **BISSON** (R18#163) **BEAULIEU**
ARCHILLE **OLIVINE** **J. ALPHONSE** **URSULE A.**
1908 - 1981 1909 - 1999 1914 - 2001 1912 - 2004
My Jesus mercy

(R18#164)

LACHARITE
BERTRAND A. CONSTANCE
1912 - 1980 1916 - 1990

(R18#165)

CARON
LOUIS PHILIP LUCILLE R.
1909 - 1997 1910 - 1984

(R18#166)

COSTAIN
GEORGE T. GRACE E.
Dec. 15, 1902 Oct. 5, 1904
Sept. 24, 1985 July 19, 1996

(R18#167)

CAMILLA JANE
COSTAIN
July 19, 1933
Jan. 3, 2001

(R18#168)

BOURGOIN
WILLIAM L. Thy will
May 9, 1907 be done
May 30, 1988

CLARA
Nov. 25, 1905
Sept. 18, 1992

(R18#169)

QUAGLIAROLI
JOSEPH J. GLORIA E.
1902 - 1985

(R18#170)

JOSEPH J QUAGLIAROLI
Pvt US Army
World War II
Mar 16 1902 May 27 1985

(R18#171)

ALBIENE J. MARTIN
1906 - 1980

(R18#172)

COULOMBE
Husband Wife
OMER J. FLORENCE
1912 - 2002 1917 - 1992

(R18#173)

LAVOIE
MARIE-ANNE PIERRE
1903 Jan. 1, 1978 1902 Mar. 6, 1984

(R18#175)

GAGNE
ARTHUR A. IDA T.
1912 - 1977 1913 - 1999

(R18#174)

GERARD J LACHANCE
Tec 5 US Army
World War II
Sep 15 1922 Jan 9 1978

(R18#176)

LACHARITE
HENRI R. ROSE A.
1908 - 1980 1907 - 1999

(R18#177)

ANTHONY M. COLWELL Jr.

1927 - 2001

DOROTHY D. COLWELL

1930 -

ANTHONY M. COLWELL III

Our father 1960 - 1980 Hail Mary
who art in heaven Let us pray full of grace

(R18#178)

RITA MARIE SAUCIER

October 30, 1924

November 29, 2006

Sweet Mom

forever in our hearts

(R18#179)

BOUCHARD

EMILE E.

ADRIENNE B.

WWII U.S. Navy

his wife

1908 - 1993

1906 - 1990

(R18#180)

EMILE E BOUCHARD

US Navy

World War II

Jun 12 1908 Apr 13 1993

(R18#181)

LETA M ORAVETZ

1920 1996

(R18#182)

STEVE ORAVETZ

MSgt US Air Force

World War II Korea

1912 1982

(R13#183)

ERNESTINE L.

ALPHONSE L.

1906 - 1982

1912 - 1989

NOEL

(R18#184)

BELANGER

RAOUL L.

PRISCILLA G.

1915 - 1989

1922 -

(R18#185)

RAYMOND E JACQUES

PFC US Army

World War II

Jan 2 1918 Feb 5 1996

(R18#186)

THIBEAULT

RAOUL J.

LOUISE R.

Sept. 30, 1904

Aug. 3, 1905

Aug. 15, 1985

Oct. 12, 1983

God is love

(R18#187)

DUMAIS

ROBERT L. LOUISE B.

Mar. 3, 1915 May 17, 1922

Oct. 12, 1997

(R18#189)

ANTHONY M COLWELL Jr

Cpl US Army

World War II Korea

Apr 25 1927 Aug 15 2001

(R18#188)

ROBERT L DUMAIS

US Navy

World War II

Mar 3 1915 Oct 12 1997

(R18#190)

CANTIN
RODOLPHE F. ALICE M.
1912 - 1990 1907 - 1983

(R18#191)

GAGNON
PLACIDE E. CECILE A.
June 27, 1911 Feb. 14, 1919
Dec. 22, 1991

(R18#192)

ROLAND R PARADIS
SN US Navy
World War II
Sep 25 1926 Apr 17 1982

(R18#193)

Husband SAUCIER Wife
GEORGE A.
1922 - 1988

(R18#194)

JORDAN
ELMER J. ANTOINETTE L.
1906 - 2005 1907 - 1989

(R18#195)

VICTOR J QUAGLIAROLI
Nov. 19, 1950
June 3, 1993
Eternal peace with God

(R18#196)

Mike's FOLGER
Papa
MARTIN O. PRISCILLE A.
1920 - 1990 1923 -

(R18#197)

MICHAEL MARTIN
LAVALLEE
May 13, 1966 - Apr. 29, 1989
Eric's beloved father
now his guardian angel

(R18#198)

ALLISON M. MOORE
Mar. 3, 1972 Mar. 15, 1998
Grieve not nor speak of me with
tears ... but laugh and talk
of me as if I were beside you.

(R18#199)

RANDELL C. MOORE
December 21, 1942
May 3, 2001

(R18#200)

LEVERONE
ALFRED E. LILLIAN L.
July 26, 1921 Apr. 25, 1926
Jan. 29, 1998

(R18#201)

ST. JEAN
LUCIEN
Sept. 20, 1916 June 21, 1941
Oct. 2, 2002

CORINNE
Mar. 15, 1917
Aug. 4, 2006

(Note: 2 linked rings
under center date.)

(R18#202)

DONALD O.
May 19, 1937
May 14, 2006

RAYMOND

Sept. 3, 1956

DENISE D.
Mar. 3, 1937

(Note: 2 linked rings
over center date.)

(R18#203)

LIONEL J. DESJARDINS
Oct. 3, 1933 May 9, 2007
JEANNINE M. DESJARDINS
Dec. 28, 1936
JEFFREY J. DESJARDINS
Apr. 1, 1957

(R18#204)

DANIEL J DESJARDINS
Sp 4 US Army
May 23 1959 Mar 2 2000

(R18#205)

VICTOR J QUAGLIAROLI
Sp 4 US Army
Vietnam
Nov 19 1950 Jun 3 1993

(R18#206)

MARTIN O FOLGER
US Navy
World War II
Nov 21 1920 Jun 18 1990

(R18#207)

BARIBEAU
GERARD A. LOUISE A.
Dec. 6, 1910 June 16, 1914
Dec. 30, 1999 April 7, 2006

(R18#208)

ARTHUR B. GROVES
May 30, 1927 - Aug. 21, 1999
CELINE J. GROVES
Sept. 18, 1931
RACHEL GROVES
Apr. 30, 1957

(R18#209)

ALFRED E LEVERONE
US Army
World War II
Jul 26 1921 Jan 29 1998

(R18#210)

THIBEAULT
ROGER J. DORIS L.
1936 - 1937 - 1999

(R18#211)

MENARD
PAUL L.
Dec. 24, 1932 May 11, 1957

JEANNETTE R.
Sept. 4, 1933
Dec. 27, 2003

(Note: 2 linked rings
above center date.)

(R18#212) ANTONIO W. CAREY
Sept. 17, 1942 -
JULIE A. CAREY
May 17, 1946 -
MATTHEW S. CAREY
Aug. 15, 1970 - May 18, 2005

(R18#213) JOSEPH M. MENDES
Jan. 23, 1931 Dec. 17, 2003
LOUISE C. MENDES
Aug. 14, 1934

(R18#215) FAVREAU
RONALD R. THERESA M.
July 9, 1929 Sept. 26, 1929
Jan. 28, 2002

(R18#214) DENNIS W. RIENDEAU
January 17, 1947
July 1, 2002

(R18#217) FAVREAU
ANNIE WILBROD O.
1902 - 1974 1898 - 1992
Jesus Marie Joseph

(R18#216) RONALD R FAVREAU
US Army
Korea
Jul 9 1929 Jan 28 2002

(R18#219) JOEL P. ROSE C.
1898 - 1974 1906 - 1973
LEBEL

(R18#218) South Face:
Rev. J. WALTER
McFARLANE
July 5, 1899 - Dec. 15, 1979
North Face:
The Crucifixion

(R18#220) In memoriam
Fr. ALBERT LEBEL S. M.
1903 1975
Ordained Priest 1930

(R18#221) PIERRE PAUL MARIE IDA
1902 - 1995 1892 - 1978
LEBEL

(R18#222) BRASSARD
ALMA M. JOSEPH F.
1895 - 1973 1885 - 1973

(R18#223) Husband Wife
CHESTER J. SOUCIE HILDA A. FENIMORE
April 2, 1905 Nov. 23, 1907
Feb. 21, 1975 June 25, 1976
SOUCIE
In loving memory

(R18#224) LANTEIGNE
ELIZABETH M. WILFRID J.
1901 - 1981 1903 - 1979

(R18#225) HOULE
GERARD LEO J.
1924 - 1977 1903 - 1985
In God's care

(R18#226)

COULOMBE
LUCIENNE M. GEORGE J.
1915 - 1977 1914 - 1994
In God's care

(R18#227)

McCABE
MATTHEW J. GEORGIANNA J.
1901 - 1985 1912 - 2005

(R18#228)

PIUZE
ALFRED F. JEANNE
1909 - 1985 1906 - 1997

(R18#229)

VIOLETTE R. MARTIN
Sept. 27, 1917
Feb. 8, 2006

(R18#230)

MOEYKENS
MAURICE J. BLANCHE I.
1902 - 1978 1919 - 1989

(R18#231)

BOLLINGER
PAULINE C. JOHN G.
1924 - 2001 1922 - 1978

(R18#233)

LUDGER JEANNETTE
1904 - 1983 1907 - 1978
MICHAUD

(R18#232)

JOHN G BOLLINGER
ACdr US Navy
Korea Vietnam
Sep 7 1922 Apr 21 1978

(R18#234)

PELLETIER
PRISCILLE C. WALLACE A.
1921 - 2005 1921 - 2000

(R18#235)

WALLACE A PELLETIER
PFC US Army
World War II
July 11 1921 Mar 5 2000

(R18#236)

ROBERT H. MUGUETTE D.
1937 - 1980 1938 -
In loving
memory
ST. PIERRE

(R18#237)

ANNE J. ALBERT
1932 -

(R18#238)

ALBERT
ALFRED L. AGNES P.
1902 - 1980 1912 - 2003

(R18#239)

ST. PIERRE
YVONNE M. ALFRED J.
Oct. 23, 1905 Apr. 5, 1905
Mar. 26, 1980 May 27, 1988

(R18#240)

ROGER J. FOURNIER
June 21, 1955
Mar. 5, 1998
Son of ANTONIO and HAZEL

(R18#241)

ROLAND F. BISHOP
Apr. 5, 1926
May 6, 2000

(R18#242) JUNE G. HELD
June 21, 1928 Apr. 25, 2006
ALLEN E. HELD
May 29, 1934

(R18#243) FOURNIER
ANTONIO A. HAZEL ATKINS
July 30, 1923 June 6, 1925
Feb. 4, 1994 Dec. 28, 1998

(R18#244) ANTONIO A FOURNIER
Tec 5 US Army
World War II
Jul 30 1923 Feb 4 1994

(R18#245) LEVESQUE
EUGENE C. ALEXINA A.
1905 - 1980 1897 - 1989

(R18#246) CASEY
JOHN B. GERTRUDE
1913 - 1980 1918 -

(R18#247) JOHN B CASEY
S Sgt US Army
World War II
1913 1980

(R18#248) LABEL
HENRY EVA
1895 - 1981 1896 - 1981

(R18#249) ROMAIN B. SAVOIE
1929
MADELEINE M. his wife
1926

(R18#250) LOUIS J DRAPEAU
LCdr US Navy
World War II
Nov 29 1913 Feb 13 2004

(R18#251) HENRY V BONZACNI
Lt US Navy
World War II
May 1 1918 Mar 19 1998

(R18#252) GEORGE DRAPEAU Jr
LCdr US Navy
World War II
Sep 27 1908 Oct 25 1999

(R18#253) GIARD
MARCEL JOSEPH NANCY CHARRON
Aug. 8, 1918 Oct. 4, 1917
Jan. 15, 2002 July 24, 2007

(R18#254) MARCEL J GIARD
Maj US Army
World War II
Aug 8 1918 Jan 15 2002

(R18#255) LORD
ANTONIO S. ADRIENNE B.
1914 - 1985 his wife
1918 - 1997

- (R18#256) ANTONIO S LORD
Sgt US Army
World War II
Apr 22 1914 Sep 13 1985
- (R18#257) PATRICIA R. WEBER
1947 - 1983
- (R18#258) ROLANDE LACHANCE
Mar. 10, 1923
Feb. 2, 2005
- (R18#259) LIONEL C LACHANCE
Tec 4 US Army
World War II
Feb 26 1919 Jan 27 2004
- (R18#260) Mother dear
MAMIE M. NEELD
April 16, 1911
November 8, 2000
- (R18#261) HALEY LYNN RIENDEAU
with fond memories and
loss in our hearts
we will always
love you
Mom and Dad
March 13, 1997
- (R18#262) What the heart has cherished
can not be forgotten
ROGER CAMILLE
RIENDEAU, Jr.
March 4, 1953 - December 7, 2001
- (R18#264) MARK J. GIARD. D.C.
October 24, 1955
July 9, 1991
- (R18#263) ROY
JEAN PAUL MURIELLE C.
Aug. 2, 1921 Nov. 8, 1923
Feb. 4, 1997 Sept. 15, 2002
- (R18#265) LEWIS
FRED E. LEWIS VENISE CHARRON
Apr. 28, 1924 Oct. 25, 1922
Jan. 1, 2003
- (R18#266) FRED E LEWIS
MOMMI US Navy
World War II
Apr 28 1924 Jan 1 2003
- (R18#267) YOUNGJIN CHOI
born Nov. 30, 1969 in Seoul, Korea
died May 14, 1993
- (R18#268) Beloved mother
VALEDA J. DAVIS
June 16, 1913
July 15, 2001

(R18#269) O' TOOLE
VICTOR P. CLAIRE M.
Aug 23, 1917 Sept. 1, 1947 Nov. 14, 1923
Apr. 13, 2000 (Note: Center date with 2 linked rings above.)

(R18#270) YATES (R18#271) BRAMSEN
LUCAS M. LOUISE PETER JOSEPH ANNE MARGARET
June 3, 1902 Apr. 13, 1907 Maj. U.S. Air Force beloved wife
Feb. 20, 1999 July 13, 1998 World War II 29 Jun 1928
3 Apr 1920 - 11 Jul 1998

(R18#272) STUPINSKI
HENRY M. CLARA C. (Note: Center date over 2 linked rings.)
Sept. 8, 1928 Oct. 2, 1949 Mar. 6, 1925
Aug. 7, 1998

(R18#273) NOLAN
JAMES J. BERNADETTE P. (Note: Center date under 2 linked rings.)
July 16, 1928 June 27, 1953 Dec. 17, 1921
May 14, 1999

(R18#274) Dad (R18#275) ST. PIERRE
OTILIO L. MURILLO CHARLES O. EDNA S.
December 13, 1934 Dec. 6, 1915 Oct. 2, 1921
January 1, 1998 Feb. 22, 2004

(R18#276) CHARLES O ST PIERRE (R18#277) LARRABEE
Sgt US Army WILLIAM E. BARBARA H.
World War II 1947 1944 - 2000
Dec 6 1915 Feb 22 2004

(R18#278) BOLLINGER (R18#279) J BOYD BOLLINGER
JOHN BOYD SP4 US Army
July 24, 1946 Vietnam
Apr. 28, 2007 Jul 24 1946 Apr 28 2007

(R18#280)

THIBOUTOT

ROLAND J. Sr. RUTH H.
1915 - 2006 July 10, 1937 1918 - 2001

(Note: Center date over 2
linked rings.)

(R18#281)

JEANNETTE M. COFFIN
August 11, 1936

(R18#282)

ROBERT J. PELLETIER
January 26, 1969
September 23, 2000

(R18#283)

CHARLES E. TREMBLAY
Mar. 15, 1922 - Aug. 9, 2000
his wife
GEORGETTE F. TREMBLAY
Nov. 27, 1922 -

(R18#284)

GLORIA RUSSETT NUTT
January 18, 1922
March 15, 2000
You are loved

(R18#285)

AGNES D. LEAVITT
Nov. 23, 1914 Feb. 22, 2000

(R18#286)

YVETTE PINARD
Apr. 19, 1909
Sept. 29, 1975

(R18#287)

BOUCHARD

GERALD Together GERMAINE
1919 - 1986 forever 1920 -

(R18#288)

BERNIER
EDWARD J. THERESE
1931 - 1976 1933 -
In loving memory

(R18#289)

MORISSETTE

M. EVA J. ERNEST
June 25, 1902 Jan. 2, 1896
Nov. 7, 1975 Nov. 20, 1984

(R18#290)

ARTHUR J. INEZ E.
1908 - 1985 1913 - 2007
BOUSQUET

(R18#292) South Face:

LEBOURDAIS

GEORGE C.

March 12, 1915 - Dec. 7, 1980
his wife

EUGENIE MENARD

Jan. 30, 1917 -

North Face:

John Baptizes Jesus

(R18#291)

ST. PIERRE

WILLIAM F. Jr. GERMAINE B.
Apr. 4, 1914 Nov. 24, 1915
June 9, 1997

(R18#293)

GEORGE C LEBOURDAIS
Tec 4 US Army
World War II
1915 1980

- (R18#294) Son
MAURICE W. BOUCHARD
August 6, 1943
August 19, 1999
- (R18#295) **JOSEPH EDWARD BERNIER**
Cpl US Army
Korea
1931 1976
- (R18#296) ANITA CLOUTIER
July 24, 1926 - July 18, 1998
wife of
GEORGE R. POTTER
- (R18#297) **FERDINAND J N CLOUTIER**
Maine
T Sgt Army Air Forces
World War II
April 18 1910 Oct 25 1973
- (R18#298) **JERRY R. PELLETTIER**
Sept. 4, May 8,
1959 1981
- (R18#299) **BERNARDINE BRENNAN**
1934 - 1998
- (R18#300) DEHETRE
MARIE T. **REAL F.**
1926 Married 1923 - 1979
 May 29,
 1948
- (R18#301) **REAL F DEHETRE**
SSgt US Army
World War II
1923 1979
- (R18#302) CARON
FERNAND PUDGY **ALICE DEHETRE**
1914 - 1995 1921 -
- (R18#303) **FERNAND N CARON**
Sgt US Army
World War II
Oct 8 1914 Jun 23 1995
- (R18#304) DUBE
LEO **LUCILLE** **MICHAEL**
1908 - 1986 1910 - 1982 1943
In loving memory
- (R18#305) THIBEAULT
IDA M. **IRENEE R.**
1911 - 1979 1912 - 1994
In loving memory
- (R18#306) BERNIER
JOSEPH A. **CLAIRE I.**
1921 - 1979 1921 - 2005
- (R18#307) **JOSEPH A BERNIER**
Tec 4 US Army
World War II
1921 1979

(R18#308) GERALDINE F.
MASSE
1914 - 1982

(R18#309) SAUVE
JAMES A.
1914 - 1981

(R18#310) THIBODEAU
PAUL J. IRENE G.
Jan. 20, 1923 Oct. 15, 1919
July 13, 2001

(R18#311) RACINE
IMELDA ROSARIO
1902 - 1970 1898 - 1982

(R18#312) RACINE
PAUL E. NANCY V.
1936 - 2003 1935 - 1988

(R18#313) MARILYN T. REHFIELD
Dec. 27, 1938
Aug. 7, 1983

(R18#314) LUCIENNE L. BERNIER
Jan. 4, May 17,
1911 1994

(R18#315) "Babe" his wife
WILFRED M. YVONNE T.
1929 - 1987 1932 -
Together forever
LAFFELY

(R18#316) FORTIN
MARGUERITE M. J. ANTONIO
Dec. 30, 1916 Feb. 10, 1918
May 11, 1983

(R18#317) DAVIS
JOHN B. GILBERTE A.
Apr. 21, 1913 June 5, 1916
Dec. 24, 1992

(R18#318) JOHN B DAVIS
US Navy
World War II
Apr 21 1913 Dec 24 1992

(R18#319) JONES
ROBERT JOHN JOAN CATHERINE
1923 - 1990 1925 -

(R18#320) HUARD
JEAN B. ANNIE F.
1922 - 2001 1922 - 1984

(R18#321) MAYNARD
ANDREW R. Together AGNES A.
July 2, 1917 forever Nov. 19, 1934
Aug. 30, 2004

- (R18#322) STAMAS
PETER Married THERESA ROY
1921 - 1985 Aug. 9, 1922 -
1947
- (R18#323) PETER STAMAS
AZO US Navy
WWII Korea Vietnam
Aug 25 1921 Jan 30 1985
- (R18#324) RACINE
GERARD R. MARY S.
May 2, 1916 Aug. 30, 1921
May 22, 2004
- (R18#325) MORIN
CLAUDE E. LEONA A.
Oct. 29, 1928 Feb. 10, 1917
Dec. 24, 1985 Apr. 30, 1988
- (R18#326) THIBEAULT
FLORIDO G. IRENE E.
Apr. 6, 1916 Mar. 14, 1915
June 22, 2000
Married Oct. 5, 1946
- (R18#327) FLORIDO G THIBEAULT
Sgt US Army
World War II
Apr 6 1916 Jun 22 2000
- (R18#328) POITRAS
ROSAIRE LEO MARIE ROSE
1918 - 1986 1922 -
- (R18#329) ROSAIRE LEO POITRAS
PFC US Army
World War II
Feb 13 1918 Nov 28 1986
Purple Heart
- (R18#330) JOHN D YACANO
S Sgt US Marine Corps
World War II
Jan 15 1919 Jun 6 2000
- (R18#331) MESSIER
PHILIP L. KATHLEEN
1924 - 1990 1925 - 1998
- (R18#332) PHILIP L MESSIER
US Navy
World War II
Mar 21 1924 Aug 6 1990
- (R18#333) DESJARDINS
PAUL T. GLADYS BAUMANN
1920 - 1995 1926 - 2002
We love you
- (R18#334) Beloved mother
MARY A. LEX FRASER
November 3, 1910
August 6, 2004
- (R18#335) JAMES JIM BRADY Jr.
July 10, 1930 - Feb. 12, 2006
ETHEL M. BRADY
Jan. 27, 1934 -

(R18#336)

	SMART		
OSCAR J.		BEULAH M.	(Note: Center date and text below
1917 - 2003	Married	1917 -	2 linked rings.)
	Oct. 1, 1941		

(R18#337)

MORNEAU
 GERARD J. ALINE V.
 July 16, 1916 July 5, 1924

(R18#338)

LIVVERNOIS
 JEAN PAUL YVETTE M.
 Nov. 3, 1920 July 21, 1919
 Feb. 16, 2005 Aug. 29, 2005
 Married May 30, 1949

(R18#339)

LAWRENCE H YOUNG
 AFCM US Navy
 Vietnam
 Feb 7 1937 Sep 18 2000

(R18#340)

HELIE
 ROBERT L. DOROTHY L.
 Jan. 7, 1921 Jan. 18, 1920
 June 28, 2001

(R18#341)

CLAUDIA LAVIGNE
 October 4, 1910
 March 27, 1999

(R18#342)

	THIBEAULT	
LAUREAT J.		SIMIENNE L.
Dec. 12, 1926	May 28, 1949	Oct. 21, 1928
		Mar. 14, 2004

(Note: Center date below 2 linked rings.)

(R18#343)

	DUVAL	
GEORGE W.		CONSTANCE L.
Dec. 31, 1920	May 30, 1950	Feb. 10, 1923
June 11, 2005		Jan. 1, 1999

(Note: Center date over 2 linked rings.)

(R18#344)

GEORGE W DUVAL
 S Sgt US Army Air Force
 World War II
 Dec 31 1920 Jun 11 2005

(R18#345)

BLANCHE DIONNE
 RODRIGUE
 1904 - 2000
 In God's care

- (R18#346) PETER M. STAMAS
1950 - 1997
- (R18#347) EDNA M. KENNY
November 9, 1903
February 4, 1997
- (R18#348) CALVIN W RICH
Lt Col US Army Air Forces
WWII Korea Vietnam
Aug 3 1916 Dec 6 1999
- (R18#349) LEIGH K. RICH
Mar. 24, 1921
Sept. 4, 1996
- (R18#350) HAGE
OLAF H. 3rd ELIZABETH G.
July 12, 1939
July 17, 1996
- (R18#351) FREDERICK WARREN REDDY
US Navy
Sep 7 1931 Dec 13 1995
- (R18#352) ELIZABETH PIERRE R.
1912 - 1975 1905 - 1980
LABONTE
- (R18#353) EMELIA LAMARRE
Oct. 19, 1896
Nov. 28, 1975
- (R18#354) LAMARQUE
SYLVIO E. FRED A O.
1912 - 2003 1912 - 1996
Together forever
- (R18#355) JEANNE A. BERNIER
1913 - 1988
- (R18#356) EVA LAVOIE
Feb. 11, 1905 - Nov. 24, 1976
In loving memory
- (R18#357) BERNIER
GEORGE MARY
Sept. 2, 1906 Feb. 10, 1914
Apr. 23, 1977
- (R18#358) ALICE Y. BOUCHARD
Dec. 23, 1972
- (R18#359) CHARLES A. ROGERS
Oct. 10, 1916
Jan. 11, 1984
- (R18#360) HELEN M. ROGERS
Dec. 4, 1915
Oct. 31, 1974
- (R18#361) JEAN L. MASSE
1914 - 1989

(R18#362) ALICE M.
LABBE
Mar. 1, 1911
July 18, 2004

(R18#363) PHILIP O.
LABBE, Jr.
July 29, 1907
Dec. 30, 1998

(R18#364) LABBE
WILLIAM J. DORA A. BUKER
Mar. 26, 1904 Jan. 26, 1907
Apr. 15, 1986 May 16, 1987

(R18#365) BERNIER
AURORE D. ALCIDE A.
May 28, 1903 Nov. 6, 1907
Mar. 5, 1992 Dec. 26, 1979

(R18#366) J. ROBERT R. BERNIER
their son In God
June 11, Oct. 29, we
1942 1979 trust

(R18#367) J ROBERT R BERNIER
A1C US Air Force
Vietnam
Jun 11 1942 Oct 29 1979

(R18#368) LUCIENNE E. LAMARRE
1923 - 1981

(R18#369) FELIX O. MARY E.
1918 - 1981 1922 -
MORAIS

(R18#370) FELIX OMER MORAIS
1st Sgt US Army
World War II
1918 1981

(R18#371) BLANCHARD
OMER ALPHONSINE
1906 - 1987 1910 - 1993

(R18#372) LAURA V. BERNIER
Sept. 21, 1908 - May 30, 2006

(R18#373) BRILLANT
LUCIEN E. LORETTA A.
Sept. 30, 1909 Mar. 18, 1915
Sept. 22, 1994

(R18#374) MICHAEL K. TIMOTHY O.
1952 - 1982 1955 - 1985
MORAIS

(R18#375) PHILIPPON
Holy Bible Together forever
GERARD J. MARTHA M. DANIELLE J.
1915 - 1987 1915 - 1949 -

- (R18#376) THIBODEAU
HENRY LUCILLE A.
Oct. 23, 1910 Dec. 31, 1912
May 5, 1994
In loving memory
- (R18#377) HENRY C THIBODEAU
Tec 5 US Army
World War II
Oct 23 1910 May 5 1994
- (R18#378) LEVESQUE
ROBERT F. JEANNE
Aug. 12, 1917 Feb. 14, 1918
May 1, 1993
In loving memory
- (R18#379) ROBERT F LEVESQUE
US Army
World War II
Aug 12 1917 May 1 1993
- (R18#380) BLANCHETTE
1925 FREELAND A. 2000
his wife
1926 MARIE FLORENCE
- (R18#381) Daughter
LINDA J.
BLANCHETTE
1947 -
- (R18#382) FREELAND A BLANCHETTE
Cpl US Army
World War II
Jan 5 1925 May 23 2000
- (R18#383) DUQUESNOY
ROGER P. RHEA A.
Feb. 25, 1934 Apr. 24, 1954 Dec. 31, 1933
Nov. 28, 1996 (Note: 2 linked rings under center date.)
- (R18#384) Daughter
IRENE L. MARTIN
1931 - 1984
- (R18#385) Father
ROBERT T. MARTIN
1936 - 1999
- (R18#386) ROBERT THURON MARTIN
SOC US Navy
Jun 10 1936 May 6 1999
- (R18#387) BOURGEOIS
NARCISSE J. HEDWIDGE M.
Feb. 9, 1910 Jan. 11, 1913
June 2, 1998
- (R18#388) BELANGER
EUDORE C. GEORGETTE M.
Dec. 22, 1912 Sept. 28, 1940 June 11, 1921
Apr. 10, 2001 (Note: 2 linked rings under center date.)

(R18#388)

LEVESQUE
ROSAIRE DORIS E.
Oct. 1, 1916 Nov. 5, 1923
Aug. 5, 1997 Nov. 19, 1998

(R18#390)

ROSAIRE LEVESQUE
Pvt US Army
World War II
Oct 1 1916 Aug 5 1997

(R18#391)

REMY A THIBOUTOT
L Cpl US Marine Corps
Jun 5 1937 Feb 26 1989

(R18#392)

CHARRON
WILLIAM P. MARGARET K.
Aug. 2, 1918 Apr. 19, 1919
Mar. 15, 1996 Feb. 21, 2002

(R18#393)

WILLIAM P CHARRON
Cpl US Army
Aug 2 1918 Mar 15 1996

(R18#394)

BRETON
IRENE A. ADELARD J.
Jan. 12, 1913 Dec. 6, 1895
May 24, 1994 June 30, 1996

(R18#395)

MERRITT
CECILE A.
May 26 1917 Dec. 9, 2007

(R18#396)

Beloved mother
MABEL C. KANE
April 18, 1923
October 24, 1993

(R18#397)

BEAULIEU
BERNARD F. MONIQUE D.
1924 - 1995 1926 -
Together always

(R18#398)

BERNARD F BEAULIEU
S Sgt US Marine Corps
World War II
Dec 27 1924 Jul 22 1995

(R18#399)

RAYMOND R. BOLDUC
US Navy
World War II Korea
Apr 9 1927 Nov 29 2007

(R18#400)

LUCAS
MICHAEL A.
Oct. 14, 1910 Oct. 29, 1934
Jan. 15, 2000

LUCIENNE A.
Mar. 17, 1911
Mar. 26, 1996

(Note: 2 linked rings under center date.)

- (R18#401) FRANCIS L. WOLFE
October 24, 1928
December 2, 2004
In loving memory
- (R18#402) LORRAINE M. WOLFE
January 18, 1932
May 28, 2004
In loving memory
- (R18#403) MENDES
FRANCIS A. ELAINE
May 30, 1929 Sept. 3, 1932
Oct. 5, 1995
- (R18#404) EDWARD J. ST. PIERRE
April 9, 1922
May 13, 2007
- (R18#405) PAUL L ST. PIERRE
Aug. 14, 1928
Sept. 16, 2003
- (R18#406) EDWARD J ST PIERRE
US Army
World War II
Apr 9 1922 May 13 2007
- (R18#407) LESA A. PRATT
Sept. 20, 1960 - July 2, 1995
Infant daughter
HILARIE GRACE Feb. 1986
- (R18#408) DUMONT
JOSEPH C. YVETTE A.
Jan. 21, 1918 May 8, 1937 Apr. 13, 1920
(Note: Center date over 2 linked rings.)
- (R18#409) CAMPBELL
G. RAYMOND GEORGETTE T.
Sept. 22, 1914 Sept. 4, 1937 May 5, 1918
July 19, 1996 May 28, 1995
(Note: Center date over 2 linked rings.)
- (R18#410) THIBEAULT
HENRY W. JEANNE
1911 - 1996 1910 - 2000
- (R18#411) MORIN
CHARLES A. MARIE ANNE
1901 - 1977 1908 - 2006
- (R18#412) JOSEPH V. GAUDREAU
July 8, Feb. 11,
1900 1982
- (R18#413) PHILIPPON
JOSEPH ROSE ANNA
Mar. 1, 1898 Dec. 30, 1902
Jan. 7, 1982 Dec. 29, 1990
- (R18#414) M ANN CHASSE
Jun 6 1923 Oct 25 1998
- (R18#415) WILLIAM A CHASSE
Capt US Army
World War II
Feb 2 1918 Nov 26 1990

(R18#416) CLINTON A CHASSE
Dec 20 1954 Jan 4 2007

(R18#417) ARTHUR P. RADCLIFFE, Jr.
July 4, 1961
KAREN L. HUGHES his wife
June 2, 1964
MICHAEL A. HUGHES their son
May 13, 1980 - Feb. 23, 2008

(R18#418) JOSEPH H HUGHES
Cpl US Army
World War II
Jan 11 1920 Apr 12 1991

(R18#419) CARLOS S. PEREZ
Sept. 29, 1953
Nov. 24, 1979

(R18#420) We picture you
Dad
and we have everything
BRUCE P. OUELLETTE
Jan. 23, 1943 - Apr. 21, 1985

(R18#421) BETTY OUELLETTE MOSHER
Sept. 18, July 10,
1912 1988

(R18#422) MORIN
ANDRE CATHERINE
Dec. 26, 1913 Married July 8, 1917
Dec. 17, 1992 Dec. 26, 1936 Oct. 1, 1980

(Note: Center date and text
below 2 linked rings.)

(R18#423) ROSE STETSON
1905 1994

(R18#424) VIOLETTE
MARIE F. PIKE
Mar. 25, Nov. 5,
1915 1996

(R18#425) BERNIER
ROGER M. MONIQUE M.
Jan. 18, 1925 Oct. 27, 1928
Dec. 27, 2000

(R18#426) RIENDEAU
IRENE J. HELENA VIGEANT
July 9, 1913 June 22, 1935 Apr. 13, 1916
Nov. 28, 1988 Oct. 25, 1999

(Note: Center date below 2
linked rings.)

(R18#427) DUMAIS
JOHN B. LEODORA E. J. RONALD
Dec. 14, 1913 June 19, 1911 Mar. 23, 1943
Sept. 13, 1984 Nov. 23, 1983 Nov. 26, 1983

(R18#428)

CLOUTIER

HUBERT J. AUDREY M.
Feb. 12, 1911 Mar. 8, 1915
July 31, 2000 Dec. 1, 1995

(R18#429)

DAUPHIN
URBAIN
1924
Together
forever
PAULINE
1927

(R18#430)

BERNADETTE YVONNE
MENARD BERNIER
June 18, 1959 - Apr. 18, 1991

(R18#431)

STEINER

EDWARD T. VICTORIA B.
13 Oct. 1907 12 Oct. 1906
23 Oct. 1993 31 Dec. 2004

(R18#432)

DORIS L. TRUDELL
Nov. 20, 1924
Oct. 2, 1991

(R18#433)

THIBEAULT

(R18#434)

EMILE J THIBEAULT Jr
Cpl US Army
Korea
Aug 14 1932 Sep 15 1991

EMILE J. Jr. CAROLE A.
Aug. 14, 1932 July 25, 1933
Sept. 15, 1991

(R18#435)

Mother

MARIE N. PELLETIER
December 22, 1925
March 19, 1993

(R18#436)

K of C LEVESQUE
ROSARIO "PETE" Married MARY JANE
Aug. 16, 1915 Sept. 5, Apr. 12, 1918
1938 Dec. 26, 2000

(R18#437)

LAGANIERE

ROLAND B. PRISCILLA J.
Mar. 4, 1930 Nov. 17, 1930
Dec. 28, 2001
Married January 6, 1951
In our hearts and thoughts forever

(Note: Center text and date below
two linked rings.)

(R18#438)

ROLAND B LAGANIERE
GM 2 US Navy
Mar 4 1930 Dec 28 2001

(R18#439)

KARL PFLAUME
July 27, 1926
January 22, 2007

(R18#440) ST. LAURENT
GEORGE CHANTAL
Dec. 28, 1932 Jan. 17, 1937
July 7, 2001
ROBERT DANIEL
Nov. 15, 1960 Sept. 26, 1967
Nov. 17, 1998 Jan. 19, 1999

(R18#441) DESJARDINS
ALBERT H. BLANCHE B.
1923 - 1924 - 1993

(R18#443) LUCY A. GAMACHE
1956 - 1977
Say a Hail Mary

(R18#442) South Face:

BOUCHER
BELONE
June 29, 1886 - Aug. 16, 1968
his wife
MODESTE PLOURDE
Oct. 13, 1893 - Feb. 13, 1968
their sons
CLIFFORD J.
May 25, 1922 - Apr. 15, 1993
SAMUEL L. R.
June 22, 1930 - May 8, 2002
his wife
RITA D. LEVESQUE BOUCHER
June 6, 1930 - Mar. 20, 1988

(R18#444) GAMACHE
CHARLES L. NANCY L.
1923 - 2001 1931 - 2001

(R18#445) CHARLES L GAMACHE
Pvt US Army
Apr 12 1923 Nov 29 2001

North Face:

The Nativity

(R18#446) WILFORD W. JEANNETTE T.
1907 - 1977 1905 - 2001
LITCHFIELD

(R18#447) BERNIER
PAUL E. BERTHE L.
1914 - 1977 1918 - 1993

(R18#448) YVETTE FORTIN
DESBIENS
Dec. 17, 1913
Apr. 9, 1988
A friend to all

(R18#449) CERENUS E. EMELIA M.
1902 - 1991 1904 - 1993
PHILIPPON

(R18#450) JOHN H. CECILE P.
1918 - 1991 1931 - 1980
THOMAS

(R18#451) BENOIT
1900 ARTHUR C. BENOIT 1980
his wife
1903 ROSA CARON 1982

(R18#452)

BENOIT
HENRY L. GRACE L.
1904 - 1977 1910 - 2000

(R18#453)

ST. ONGE
JEAN ROBERT
May 1, 1925 June 30, 1951
Dec. 13, 2003

LOUISE E. COTE
Jan. 10, 1930
Jan. 14, 2007

(Note: Center date over 2
linked rings.)

(R18#454)

JEAN ROBERT ST. ONGE
US Coast Guard
World War II
1925 2003

(R18#455)

GERTRUDE A. CRIMMINS
Nov. 28, 1905
Dec. 4, 1990

(R18#456)

M. EDNA CRIMMINS
Sept. 5, 1897
Aug. 31, 1986

(R18#457)

RICHARD R. LUCILLE F.
1932 - 1983 1932 - 2006
RAYMOND

(R18#458)

RICHARD R RAYMOND
PFC US Army
Apr 4 1932 Oct 12 1983

(R18#459)

WRENN
EDWIN S. MARGARET M.
1904 - 1983 1910 - 1984

(R18#460)

PAULINE T. POULIN
April 13, 1902
May 19, 1995

(R18#461)

BOUCHARD
An angel of life
ROBERT F. ANNE M.
Aug. 22, 1947 Dec. 15, 1946
June 4, 2005
May 30, 1970

(R18#462)

BENOIT
THEODORE A. CECILE H.
1906 - 1991 1911 - 2005

(Note: Center date below 2 linked rings.)

(R18#463)

THIBODEAU
GERARD J. LORRAINE P.
July 26, 1920 June 30, 1921
Nov. 1, 1983 Jan. 26, 1995

(R18#464)

GERARD J THIBODEAU
S Sgt US Army
World War II
Jul 26 1920 Nov 1 1983

(R18#465) KENNETH S. MULLIN
May 25, 1932 Oct. 29, 1983
Sadly missed by
Mom - Dad - Sister - Brothers

(R18#466) OLGA E. FINLAYSON
Nov. 6, 1900
Aug. 18, 1990

(R18#467) MATTHEW JAMES
DONOVAN
July 29, 1961 - Oct. 16, 1990

(R18#468) SAUCIER
Loving companions
RICHARD J. JOHN LEE O.
Jan. 18, 1959 Oct. 9, 1961
Feb. 18, 1998 May 15, 1990

(R18#469) BERNIER
RAYMOND J. FLORENCE H.
Mar. 14, 1916 June 12, 1917
Feb. 19, 2001 June 12, 1991

(R18#470) BERNIER
REMI J. SIMONE A. (Note: Center date over 2 linked
Sept. 19, 1925 Jan. 25, 1947 Oct. 14, 1927 rings.)
Sept. 8, 1997 Mar. 30, 1997

(R18#471) JANET P. BERNIER
January 10, 1948
September 21, 1989

(R18#472) REMY J BERNIER
PFC US Army
World War II
Sep 19 1925 Sep 8 1997
Purple Heart

(R18#473) Mother
CARMELLE C. TREMBLAY
Feb. 5, 1927 - July 13, 1985

(R18#474) PHILIP O PINETTE
Cpl US Army
Dec 28 1930 Oct 26 1990

(R18#475) Beloved mother
CATHERINE MacMAHON
1913 - 1991

(R18#476) RAYMOND G. LABRECQUE
Sept. 29, 1965

(R18#477) DENNISON COOPER
AE 3 US Navy
1964 1984

(R18#478) THERSA A. LABRECQUE
July 17, 1958

(R18#479)	IRENE C. BEAUDOIN Sept. 21, 1931	(R18#480)	CLEMENT L. LABRECQUE Mar. 26, 1929 Jan. 2, 1994
(R18#481)	THIBEAULT KEVIN R. LINDSEY HOPE Nov. 14, 1963 June 8, 1991 May 23, 1991 "Our little angel."	(R18#482)	GAUTHIER LEOPOLD JEANNE 1905 - 1964 1908 - 2002 Jesus - Marie - Joseph
(R18#483)	PINETTE ROGER G. SHEILA A. Oct. 21, 1923 Jan. 31, 1927	(R18#484)	LABBE RUDOLPH L. BELLA Z. Apr. 13, 1917 May 7, 1916 Sept. 16, 1990 Oct. 26, 1997
(R18#485)	RUDOLPH L LABBE SFC US Army Apr 13 1917 Sep 16 1990	(R18#486)	HUPPE ROMEO J. RITA C. Dec. 9, 1923 May 25, 1925 Mar. 2, 1993
(R18#487)	LORRAINE LaBRECQUE SMITH Nov. 26, 1933 June 16, 1992	(R18#489)	ARTHUR J POULIOT Cpl US Army World War II 1914 2001
(R18#488)	ARTHUR "CHICK" Apr. 25, 1914 Jan. 16, 2001	POULIOT	JEAN L. May 30, 1920 Nov. 23, 1992
(R18#490)	MAURICE Sr. Oct. 17, 1933 June 20, 1992	LABBE You'll never walk alone	NORA E. (Note: Center text and date June 2, 1936 over 2 linked rings.)
	Married Apr. 16, 1955		

- (R18#491) **MAURICE J LABBE Sr**
BT3 US Navy
Korea
Oct 17 1933 Jun 20 1992
- (R18#492) **MARIE L. BERNIER**
"ROSETTE"
Mar. 7, 1910
July 29, 1994
- (R18#493) **LABERGE**
EMILIE F. ALICE A.
1905 - 1992 1907 - 1994
- (R18#494) **GIDDINCE**
HARRY W. GLORIA L.
1933 1933 - 1982
- (R18#495) **JOSEPH A DESBIENS**
PFC US Army
World War II
Jul 3 1913 Aug 12 1978
- (R18#496) **WILLIAM GAUDREAU**
1 Oct. 1980
- (R18#497) **ALEXANDER**
ALICE F. WILLIAM E.
1915 - 1980 1911 - 1990
- (R18#498) **JOHN A. CRIMMINS**
Sept. 19, 1899
Mar. 25, 1980
- (R18#499) **ROGER LIONEL LAVOIE**
SP 5 US Army
1941 1980
- (R18#500) **PHILIP E. BERNIER**
Dec. 26, May 19,
1908 1982
- (R18#501) **JAMES F BARTLETT** (R18#502) **GUBBINS**
US Navy THOMAS JOSEPH MARY DALL
World War II May 19, 1912 June 12, 1910
Sep 22 1925 Jul 10 1983 July 1, 1983
Joy she gave, joy she found.
- (R18#503) **FERNAND CAMILLE TREMBLAY** (R18#504) **MARY H. FEEHAN**
Tec 5 US Army Aug. 28, 1922 June 1, 1985
World War II Beloved mother
Nov 12 1923 Sep 22 1998 and grandmother

(R18#505) BLAIR - CLOUTIER
ANGELINA C. CLEMENTINE V.
Feb. 25, 1912 Sisters Apr. 25, 1909
Dec. 27, 1984 Sept. 27, 1988

(R18#506) MENARD (R18#507) BURNHAM
MARCEL A. JANE G. STANLEY D. JEANNINE S.
Mar. 12, 1923 Nov. 21, 1924 Mar. 7, 1944 Sept. 17, 1944
Nov. 22, 1989 July 15, 1990

(R18#508) GODBOUT
THOMAS ELIZABETH
Nov. 16, 1906 Love Dec. 10, 1905
Oct. 30, 1992 forever Nov. 28, 1990

ST. JOHN THE BAPTIST CEMETERY - Range Layout

Range #19

Map #1

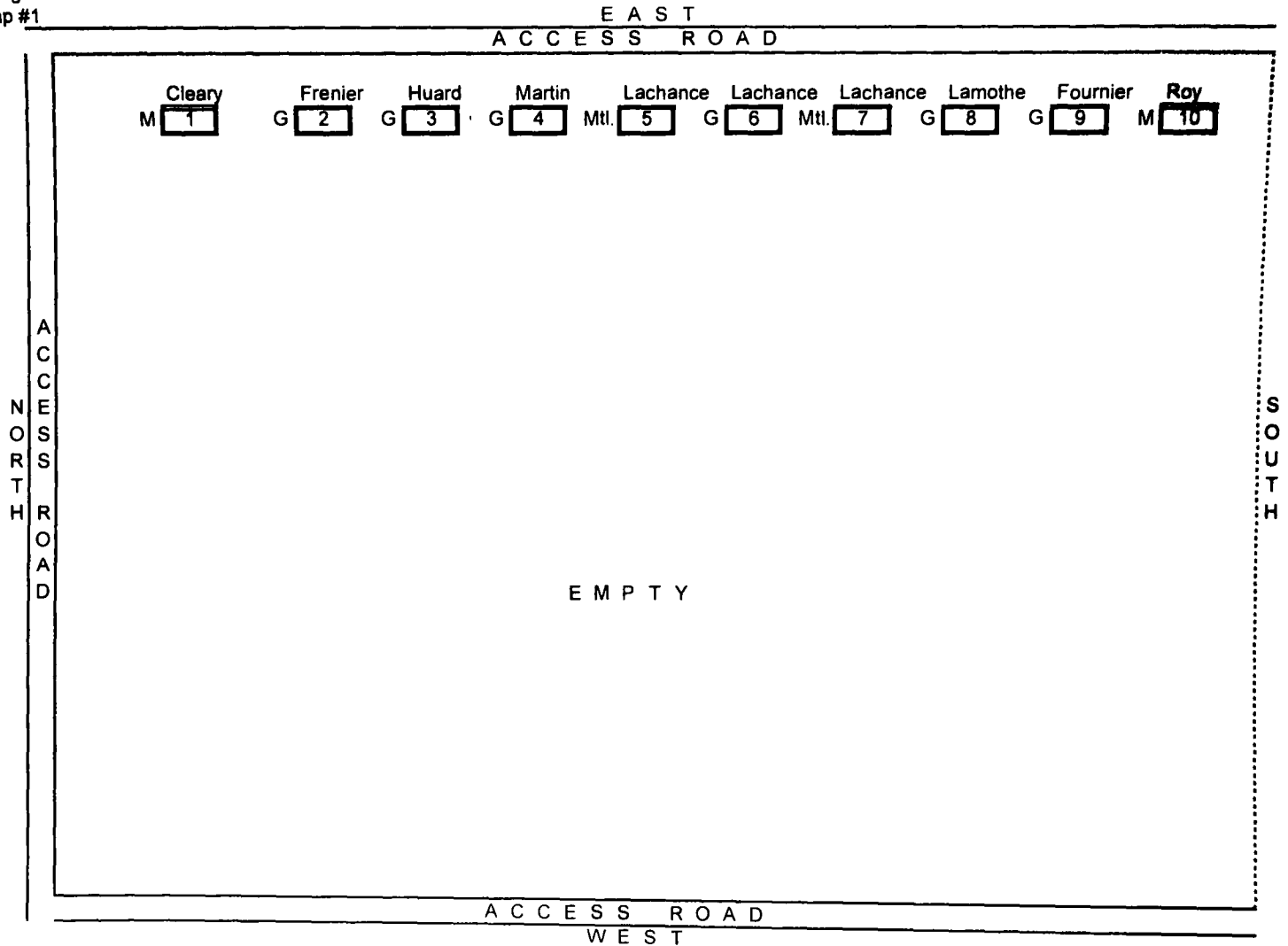

ST. JOHN THE BAPTIST CEMETERY - Range Layout

Range #19

Map #2

E A S T

N
O
R
T
H

S
O
U
T
H

G 25
Dumais
Monument

Letarte
G 24

Dionne
Monument
G 22

St. Pierre
Monument
G 23

Talbot
Monument
G 19

Boucher
Monument
G 20

Marie
G 21

Bois / Cloutier
Monument
G 17

Cloutier
Monument
G 18

Gerow
Monument
G 16

A C C E S S R O A D
W E S T

ST. JOHN THE BAPTIST CEMETERY - Range Layout

Range #19

Map #3

E A S T
A C C E S S R O A D

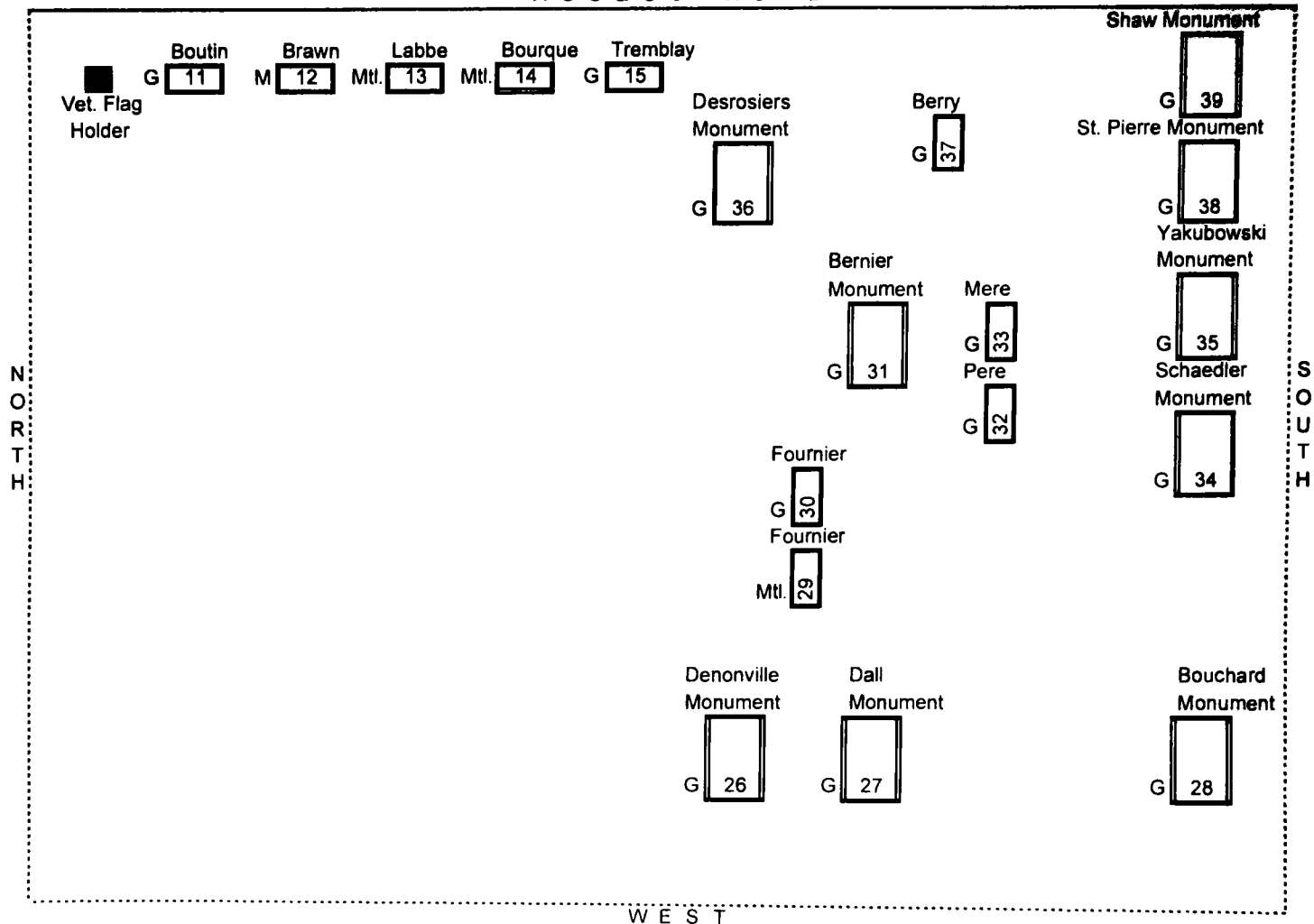

ST. JOHN THE BAPTIST CEMETERY - Range Layout

Range #19

Map #4

E A S T

N
O
R
T
H

S
O
U
T
H

Paquette
M 61

Paquette
G 62

Moreau
Monument
G 63

Urban
Monument
G 64

Moreau
Monument
G 65

Babineau
G 66
Thibodeau
Monument

Babineau
G 67

Fortin Monument
G 74 G 69 G 75 G
Raymond

Granite
Curbing

Tondreau
G 60

Babineau
G 68

Concrete Curbing

Marie Pere Mere Aldea
G 70 G 71 G 72 G 73 G
G G

G 47 G 50
Bouchard
Monument

Bouchard
G 51

Bouchard
G 52

G 53
Moreau
Monument

M 55
Arthur

Moreau
Monument
M 56

Bernier
Monument
G 58

Mother Father
G 48 G 49
Granite Curbing

M 54
Ludger

G 57
Florian/Liane

M 59
Wilfrid
Granite Curbing

Concrete Curbing

G 40
Caron
Monument

M 41
Lachapelle

G 42
Harvey

G 43
Bernier

G 45 G 46
Verna Joseph

M 44
Menard
Monument

A C C E S S R O A D

W E S T

ST. JOHN THE BAPTIST CEMETERY - Range Layout

Range #19

Map #5

E A S T

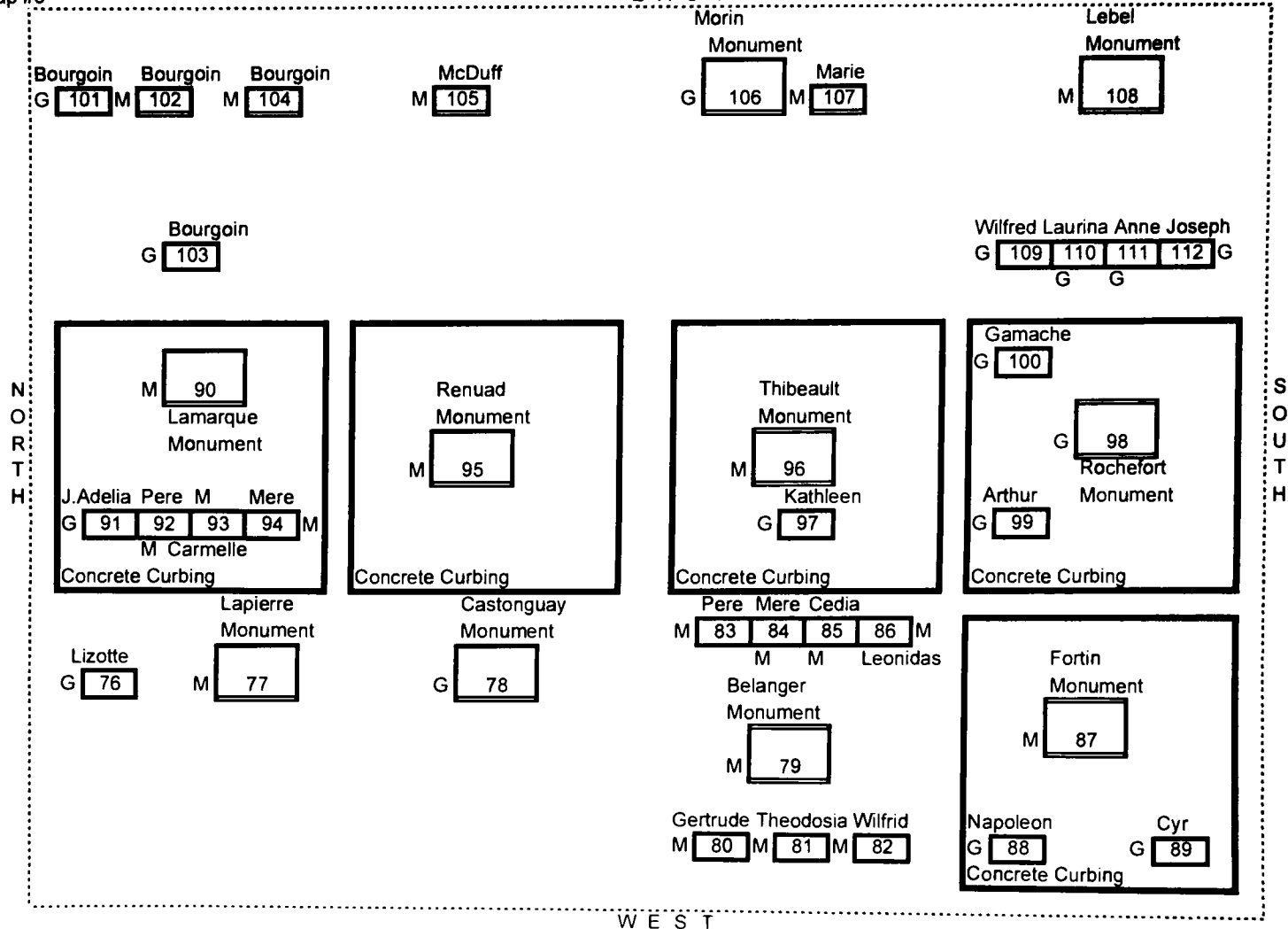

W E S T

ST. JOHN THE BAPTIST CEMETERY - Range Layout

Range #19

Map #6

E A S T
A C C E S S R O A D

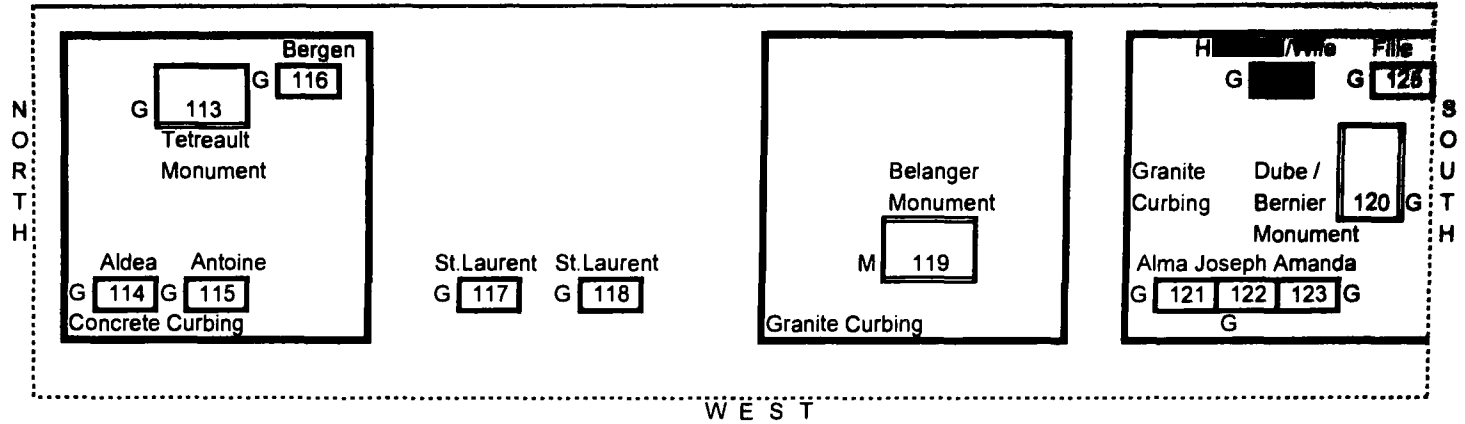

ST. JOHN THE BAPTIST CEMETERY - Range Layout

Range #19

Map #7

E A S T

N
O
R
T
H

S
O
U
T
H

Baribault
Monument
G 147

Brillant
Monument
G 148

G 149
Bernier
Monument
Mere Pere Agathe
G 150 G 151 G
Concrete Curbing

Bouchard Monument
M 153
Concrete Curbing Mtl. (?) 158
Emile Rose Marie Xavier
G 156 G Mtl. Mtl.

Antoinette Debra
M 140 141 Mtl.
Menard
Monument
Granite Curbing
M 135
Grand Grand
Mere Pere Mere Pere
M 136 138 139 M
M M

Castonguay
Monument
G 142
Father
G
Granite Curbing

Epoux Joseph
G Mtl. 146
G 144
Michaud
Monument
Concrete Curbing

(Empty)
Concrete Curbing

Moore
Monument
G 128

Caron
Monument
G 129

Staley
G 130 G
Bernier
Monument
Pere Mere Roland
G 131 G 132 G
Concrete Curbing

A C C E S S R O A D
W E S T

ST. JOHN THE BAPTIST CEMETERY - Range Layout

Range #19

Map #8

E A S T

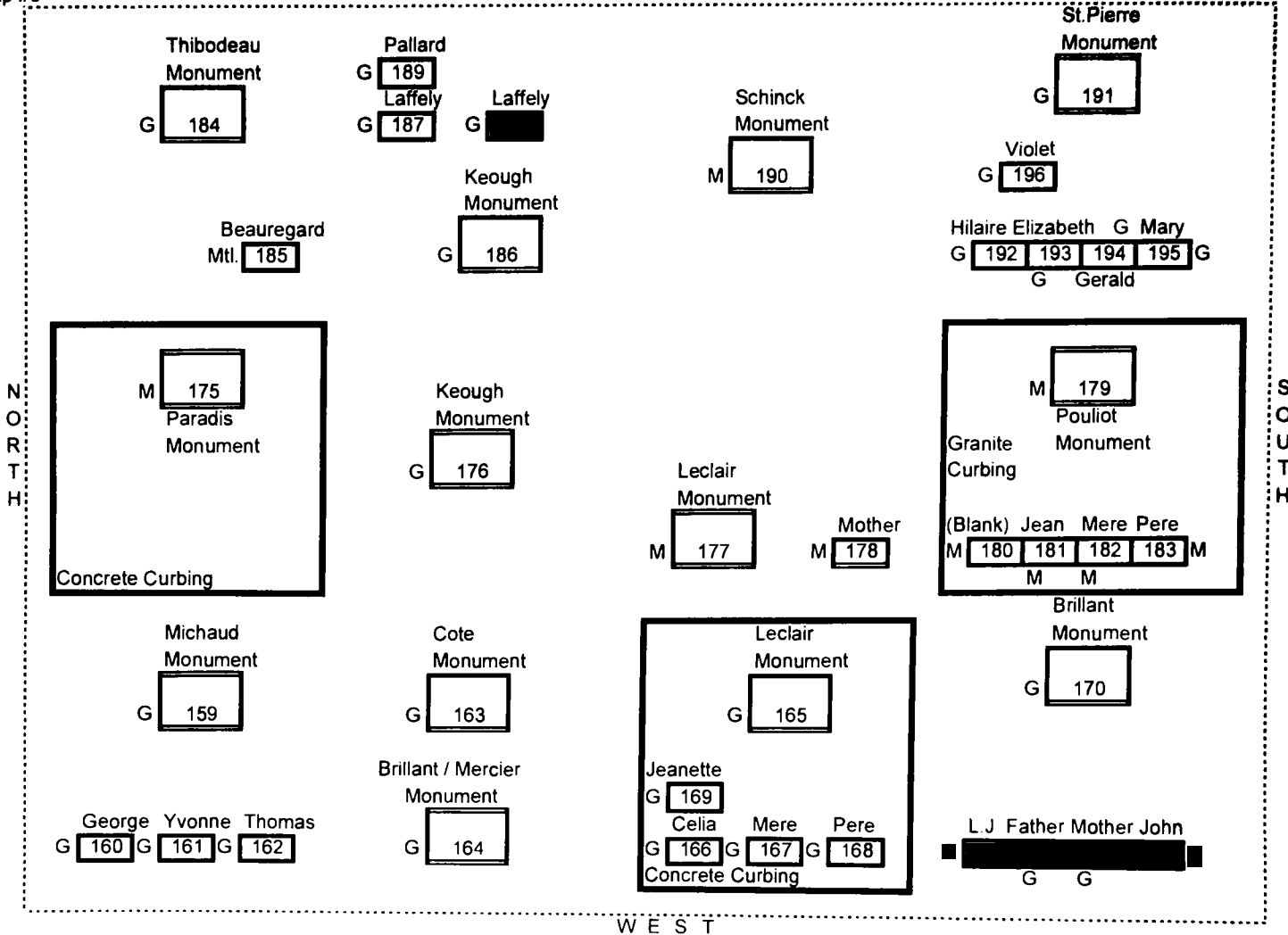

Thibodeau Monument

G 184

Pallard

G 189

Laffely

G 187

Laffely

G [Blacked out]

Schinck Monument

M 190

St. Pierre Monument

G 191

Violet

G 196

Keough Monument

G 186

Beauregard

Mtl. 185

Hilaire Elizabeth G Mary

G 192 193 194 195 G

G Gerald

M 175

Paradis Monument

Keough Monument

G 176

Leclair Monument

M 177

Mother

M 178

M 179

Pouliot

Granite Monument Curbing

(Blank) Jean Mere Pere

M 180 181 182 183 M

M M

Concrete Curbing

Michaud Monument

G 159

Cote Monument

G 163

Leclair Monument

G 165

Brillant Monument

G 170

George Yvonne Thomas

G 160 G 161 G 162

Brillant / Mercier Monument

G 164

Jeanette

G 169

Celia

G 166

Mere

G 167

Pere

G 168

Concrete Curbing

L.J. Father Mother John

[Blacked out] G G

W E S T

N O R T H

S O U T H

ST. JOHN THE BAPTIST CEMETERY - Range Layout

Range #19

Map #9

E A S T
A C C E S S R O A D

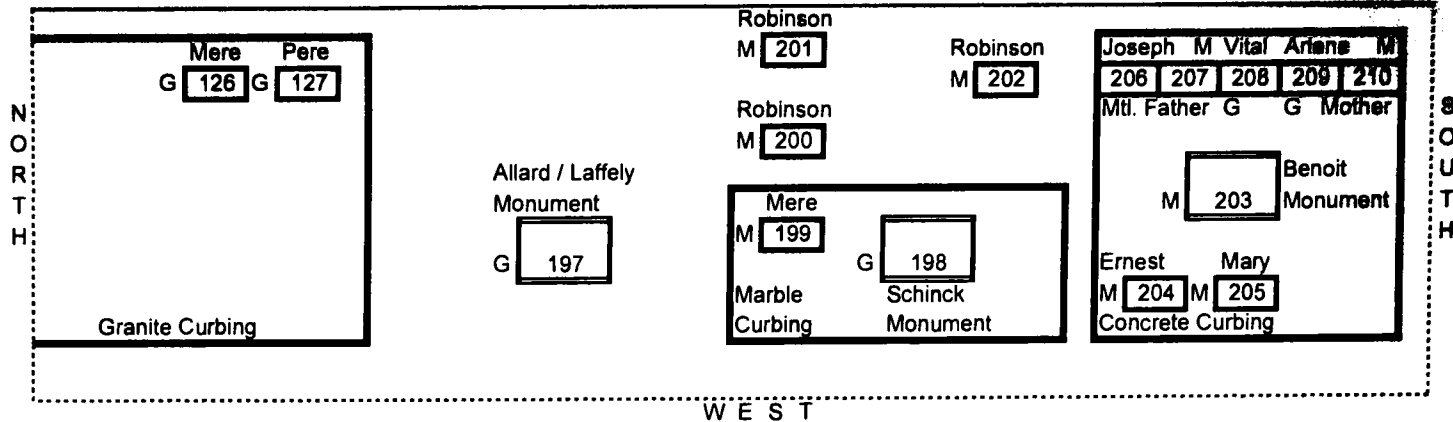

ST. JOHN THE BAPTIST CEMETERY - Range Layout

Range #19

Map #10

E A S T

N
O
R
T
H

S
O
U
T
H

Eugene M **229** Fils M **230**
Pelletier
Monument
Granite M **224**
Curbing
Marie Theodora M Mere
M **225** **226** **227** **228** M
M Pere

Allard
G **[REDACTED]**
Concrete Curbing

Lovett
M **[REDACTED]**

Paquette
Monument
G **233**
Granite Curbing

Nadeau
Monument
M **219**

Menard
Monument
G **222**

Bernard
G **[REDACTED]**
Concrete
Curbing
McElhinny / Ouellette
Monument
G **220**

Bernier
Monument
G **223**
Concrete Curbing

Caron
Marie M **213** Monument
G **212**

Ruest
Monument
G **216**

Baribeau
Monument
G **211**

Edouard
M **[REDACTED]**

Marie
M **[REDACTED]**

John
M **[REDACTED]**

Daniel
M **218**

A C C E S S R O A D

W E S T

ST. JOHN THE BAPTIST CEMETERY - Range Layout

Range #19

Map #11

E A S T

N
O
R
T
H

S
O
U
T
H

Menard
Monument
M 270

Labbe
Monument
G 275

Alphonse
M 277 M 279
Lavoie
Monument
Mere
M 278
Granite Curbing

Rose
M 287 M 280
Louis Laffely
G 284 Monument
Louis R. Marie
G 285 G 286
Louis Pere Mere
M 281 M 282 M 283
Concrete Curbing

(Blank) Pere Alice Mere
M M

Labbe
Conc. ████████

Gamache
M 256

Gamache
G ████████

Masse Monument
G 258
Madeleine
G 263 Granite Curbing
Liane Lorenzo Mere Pere
G 259 260 261 262 G
G G

Tremblay Monument
G 264
Frank
M 265
Roy
G 266
Concrete Curbing

M 267
Brassard / Lamarre
Monument
Claudia
M 268 Mere
M 269

Doris
G ████████ G 234
Brillant
Concrete Monument
Curbing
Jean Mere Pere Emilien
G 236 ████████ 238 239 G
G G

Laberge/Brillant
Monument
G 240
Claire
G ████████
Ernest Eugenie Lionel
G 241 G 242 G 243

Pere Mere
M 249 M 250
M 245
Cloutier
Concrete Monument
Curbing
Adelard Marie Marie
M 246 M 247 M 248

Lamarque/
Dumais 251 G
Monument
Leonie/
Mere Pere Henry
G ████████ G 254 255 G
St.Pierre
G ████████
Granite Curbing

W E S T

ST. JOHN THE BAPTIST CEMETERY - Range Layout

Range #19

Map #12

E A S T
A C C E S S R O A D

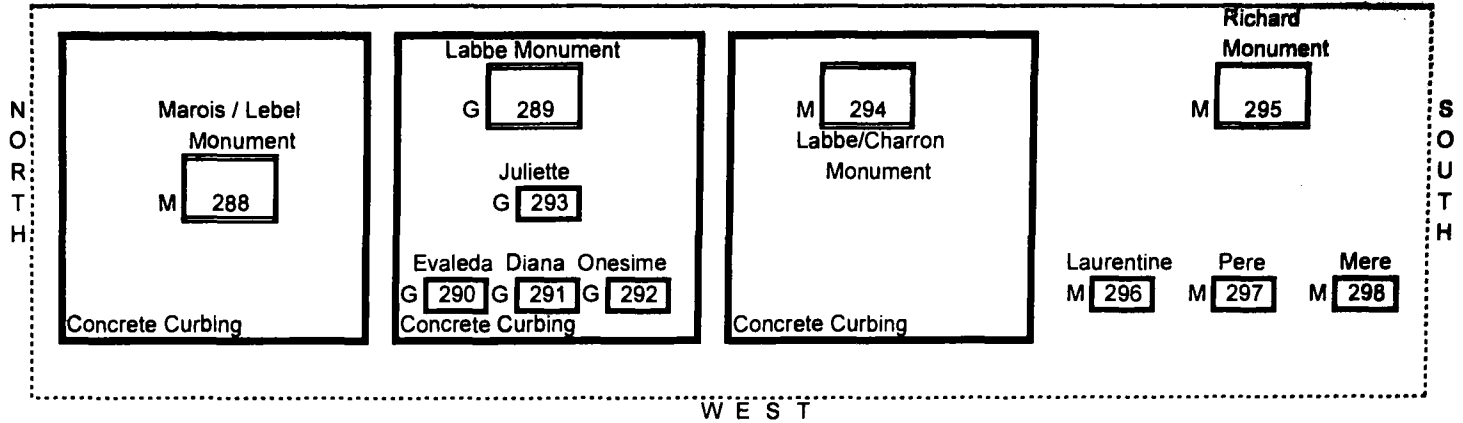

ST. JOHN THE BAPTIST CEMETERY - Range Layout

Range #19

Map #13

E A S T

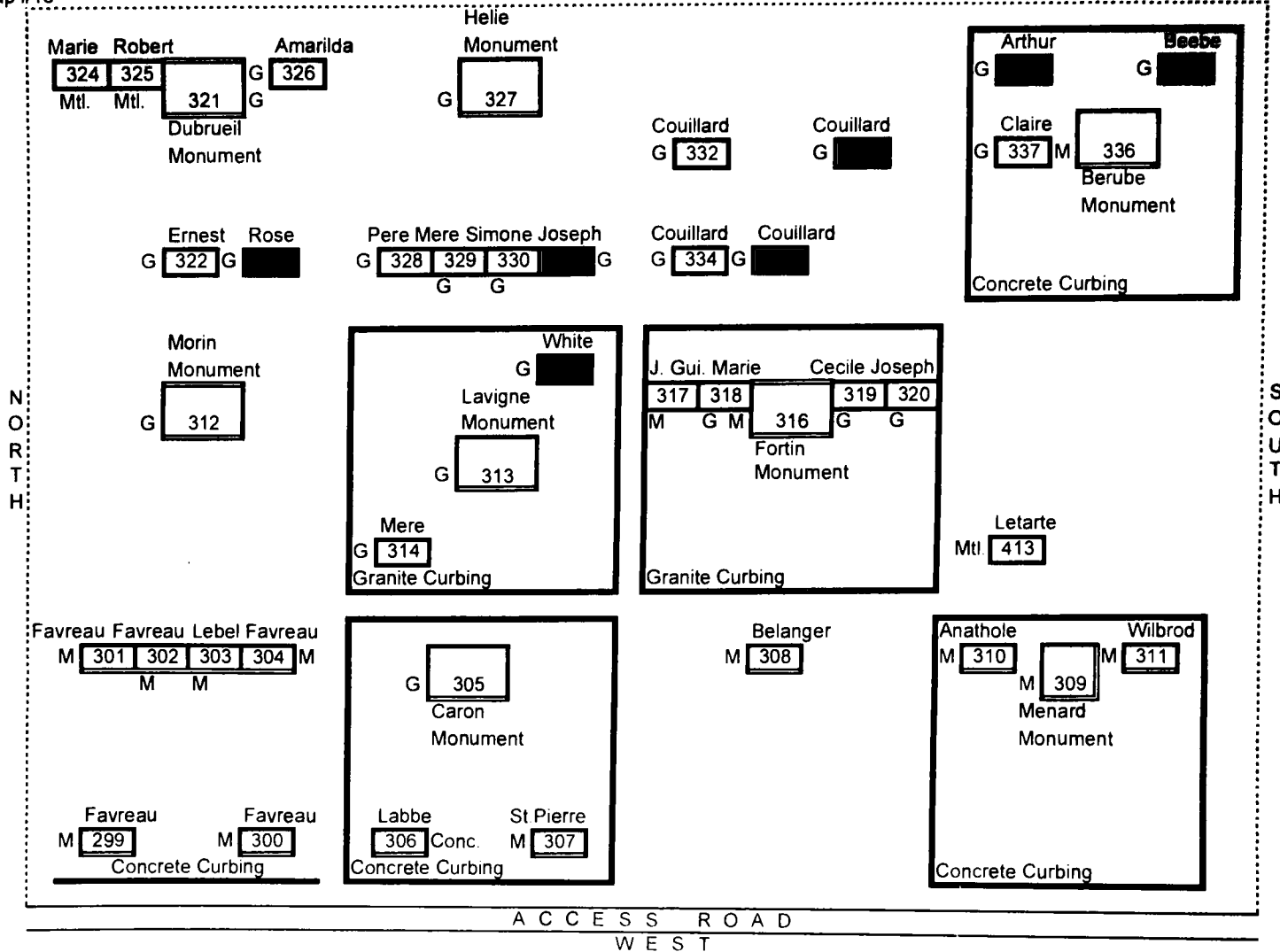

ST. JOHN THE BAPTIST CEMETERY - Range Layout

Range #19

Map #14

E A S T

N
O
R
T
H

S
O
U
T
H

G 372
Lavoie
Monument

Concrete Curbing

Florindy Gerald 375 376 G 373 M [REDACTED]
Mtl. Mtl. Livernois
Monument

Oliver/Beatrice
374

Lemieux
Monument
M 378
Granite
Curbing

Pere Mere Epouse
M 379 380 381 382 M
M M Joseph

Dagenais
Monument
M 383

Granite Curbing

Labbe
Monument
G 355 G 360 Adrien

Therrien
Monument
G 362

Concrete Curbing

Lowell
Monument
M 363

Joseph William
M 364 M 365

Edward Blanche Lucien
G 369 G 370 G [REDACTED]
Bernier/LaBrecque
Monument
G 366

Mere Pere
Conc. 367 368
Concrete Curbing Conc.

Oliva Chase Mere Pere
G 356 [REDACTED] 358 359 G
G G

Vermette
Monument
G 361

Dionne
Monument
M 340

Marquis Marquis
M 345 M 346

Brochu
Monument
G 347

Pere Mere Maurice
352 353 348 [REDACTED]
M M M Mtl.
Dube Monument
David/Carol
G [REDACTED]

Philip/Alice Steven
M 349 M 350
Granite Curbing

Pere
M 341

Mere
M 342

Lachance
G 343

Larbage
G 344

W E S T

ST. JOHN THE BAPTIST CEMETERY - Range Layout

Range #19
Map #15

E A S T
A C C E S S R O A D

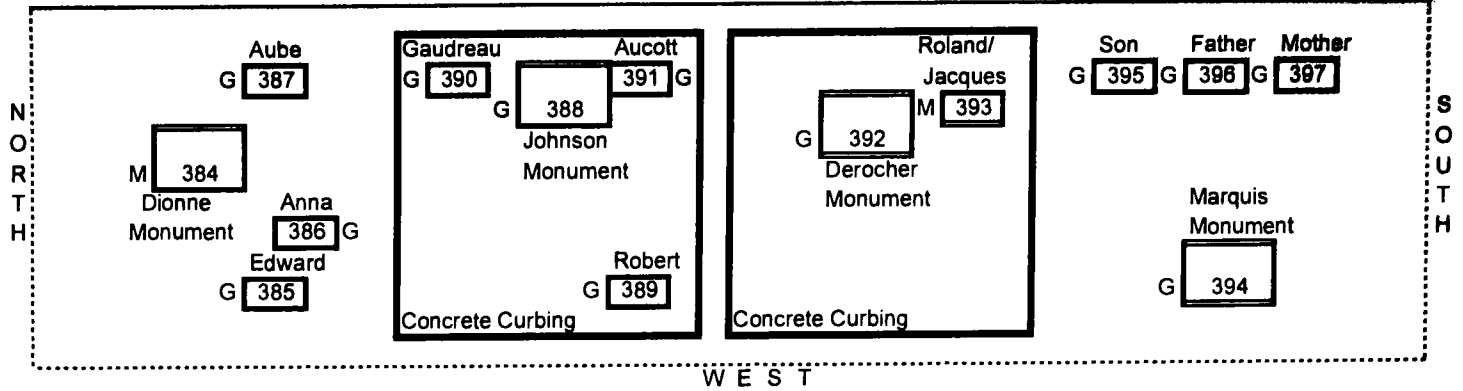

ST. JOHN THE BAPTIST CEMETERY - Range Layout

Range #19
Map #16

E A S T

N
O
R
T
H

S
O
U
T
H

Deschenes
Monument
G 430

Fortin
Monument
M 432

Theodore/ Lebourdais
Adelia Monument
G 439 M 435
Mere Pere Simonne
M 436 M 437 M 438
Concrete Curbing

George Leo
Tetreault Monument
G 443 M 440 444 G
Omer Lucien
G 441 G 442
Concrete Curbing

Pierrette
Mtl. []
Hermengeildi Wilfred/
Mtl. 433 M 434 Odnia

Ursale/
Albert/
Simonne

Rebecca Pere Emma
M 420 M 421 M 422
Bouchard
Monument
G 416

Brillant Brilliant Brilliant Brilliant
G 424 G [] 426 M []
G

Roger
G 429
Caouette
Monument
G 428

Letarte
Monument
G 412

Alexis Emma
G 414 G 415

Loretta Anita Joseph
M 417 G 418 M 419

Brillant
M []

Concrete
Blocks

Caron Caron
401 M 398
Wood
Caron Caron
G 399 G 400
Concrete Curbing

Pinette Pinette Pinette
G 403 G 404 G 405
Pinette
G 402
Concrete Curbing

Grand Pere Pere
G 410 G []
Michaud
Monument
G 406
Joseph/
Mere Josephine Adolphe
G 407 G 408 M 409
Concrete Curbing

A C C E S S R O A D
W E S T

ST. JOHN THE BAPTIST CEMETERY - Range Layout

Range #19

Map #17

E A S T

Access
Road

S
O
U
T
H

N
O
R
T
H

Cloutier
Monument

M 476

Tupper
Monument

G 478

Lapierre

G 477

Mary Jane

G 479

James

G 480

Oncle

467

Conc.

Concrete
Curbing

Pere

465

Conc.

Mere

466

Conc.

Concrete Curbing

Labbe

472

G

Labbe M Labbe Labbe

M 468 469 470 471

Labbe C&M C&M

Caron

G 474

Caron
Monument

M 473

G 475

Concrete Curbing

Castonguay

Lemieux

Pere Mere Ernest Adele

G 458 459 460 461 G

G G

Monument Toth Toth Toth

G 452 G 462 463 464 G

G G

M 445

Gamache

Concrete Monument
Curbing

Ernest M Louise G Alphon

G 446 447 448 449 G

G Zelea

Daraiche Wallace

G 450 G 451

Alfred

M 453

Victore

M 454

Jumeau Florida Fils

G 455 456 457 G

G

W E S T

ST. JOHN THE BAPTIST CEMETERY - Range Layout

Range #19

Map #18

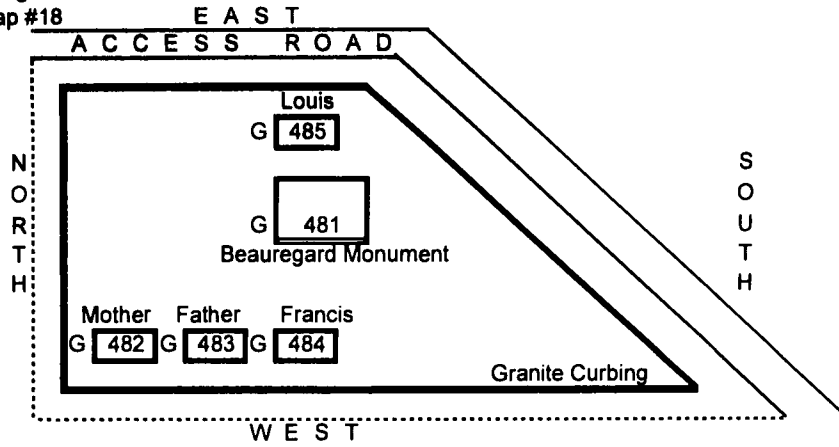

ST. JOHN THE BAPTIST CEMETERY - Range Layout

Range #19
Map #19

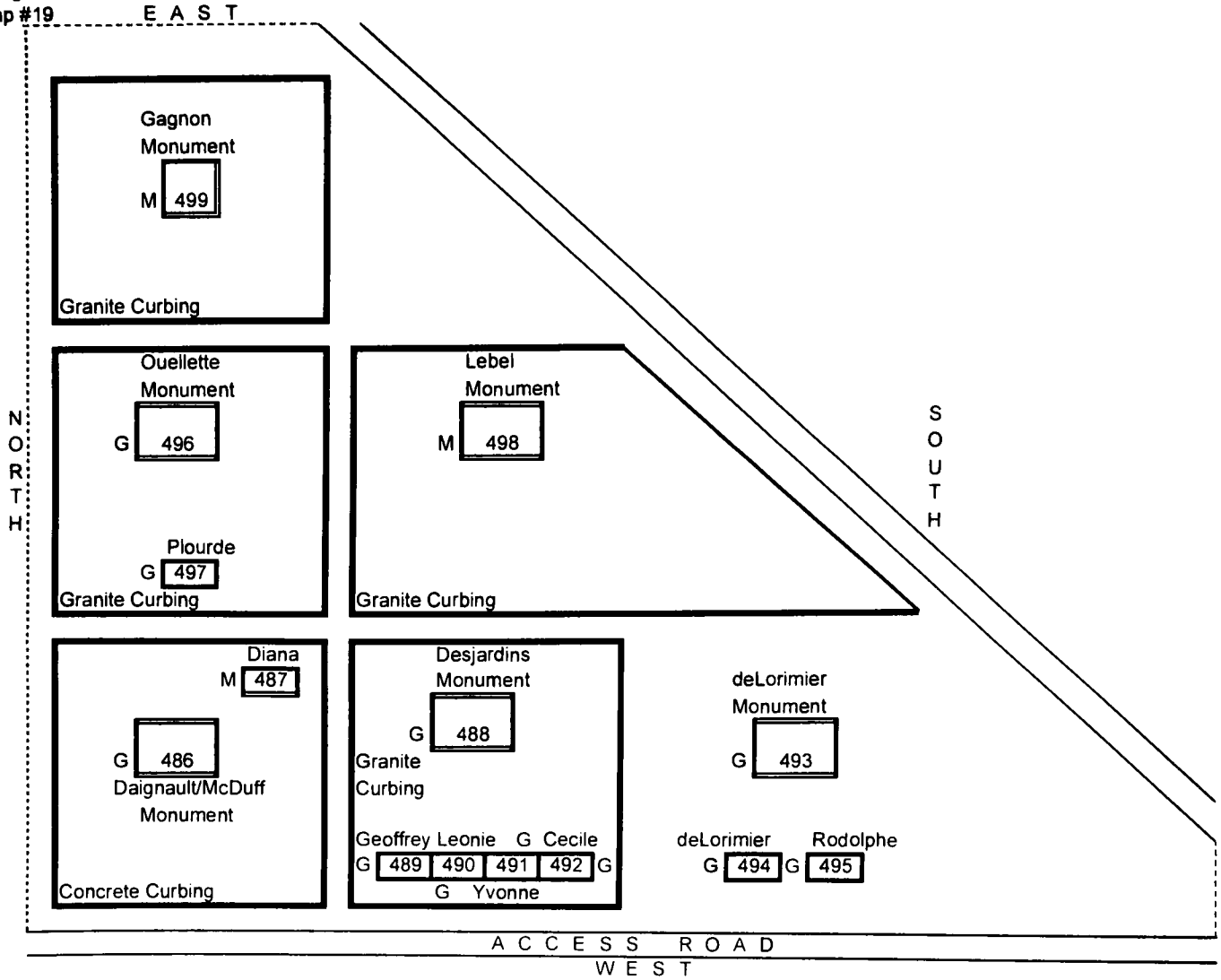

ACCESS ROAD
WEST

RANGE #19

(R19#1)

**JOSEPH
EDWARD
WILLIAM
CLEARY**
Blksmith 1
US Navy
World War I
January 20 1879
October 30 1954

Marker: U.S. Veteran

(R19#2)

**DELIA M.
FRENIER**
1893 - 1952

(R19#3)

**HUARD
FRANCOIS EMMA**
1877 - 1953 1880 - 1950

(R19#4)

Our mother
ELSIE MARTIN
Mar. 12, 1924
Mar. 31, 1952

(R19#5)

Pere **P. LACHANCE**
1869 - 1947

(R19#6)

PHILIBERT LACHANCE
1869 - 1947
son epouse
LYDIA BOUCHER
1868 - 1956

(R19#7)

LYDIA LACHANCE
1868 - 1956

(R19#8)

ARTHUR LAMOTHE
1917 - 1947

(R19#9)

ADELARD FOURNIER
1870 - 1947

PARMELA B. his wife
1880 - 1946

(R19#10)

MINNIE ROY
1872 - 1946

(R19#11)

OCTAVE BOUTIN
April 14, 1864
August 23, 1945

(R19#12)

**JOHN O.
BRAUN**
1883 - 1944

(R19#13)

JOSEPH AMEDE LABBE
Pvt US Army
World War I
Jan 7 1889 Jan 28 1944

Marker: U.S. Veteran

(R19#14) ALFRED F BOURQUE
1886 - 1944

(R19#15) Mother
ALICE TREMBLAY
1878 - 1943

(R19#16) Gerow Monument

South Face:

GEROW

North Face:

Mother
LEVONIA E.
1877 - 1955
ARVILL J.
1905 - 1964
his wife
HELEN M.
1908 - 1964
dau.
IDIS E.
1944 - 1945
INFANT FORTIN
1952

(R19#17) Bois / Cloutier Monument

South Face:

BOIS
CLOUTIER

North Face:

CAMILLE CLOUTIER
died May 5, 1943 at age of 65 yrs.
his daughter
GRAZIELLA C. BOIS
April 11, 1903 - Mar. 8, 1966
her husband
ALCIDE BOIS
Jan. 24, 1894 - Dec. 11, 1941

(R19#18) Cloutier Monument

South Face:

CLOUTIER

North Face:

1872 JOSEPHINE M. 1941
1873 TREFFLE J. 1958
1904 AGNES T. 1994
1907 ALBERT J. 1997

(R19#19) Talbot Monument

TALBOT
1885 LOUIS TALBOT 1955
son epouse
1888 ROSE ANNA LACASSE 1971
leurs enfants
1928 LAURENT 1946
1907 MARIE CLAIRE BOUCHER 1946
1855 JOSEPH LACASSE 1944

(R19#22) Dionne Monument

South Face:

DIONNE
Sacred heart of Jesus have mercy on us

North Face:

1878 CHARLES DUBE 1945
1882 MARIE-LOUISE DESLAURIER 1962
daughter
1911 EVA M. DUBE DIONNE 1972
her husband
1906 OVILA J. DIONNE 2000
daughter
1933 MARJORIE EDITH DIONNE 1935

(R19#20) Boucher Monument

IHS
1876 HORACE 1941
1881 MARIE 1960
WILFRED J. DEROCHER
1910 - 1989
YVETTE M. his wife
1911 - 1997
BOUCHER

Marker Stone:

(R19#21) MARIE

(R19#23) St. Pierre Monument

South Face:

ST. PIERRE

North Face:

1885 ALEXIS L. ST. PIERRE 1941
son epouse

1890 ANNA M. BECHARD 1981

(R19#24)

ALFRED J. LETARTE
Cpl US Army
March 27 1894 Dec 29 1974

Marker: U.S. Veteran

(R19#25) Dumais Monument

DUMAIS

K of C

R. H. "CHARLIE" Married

June 7, 1912 July 6

May 7, 1998 1940

RN

LUCILLE R.

Mar. 5, 1917

Jan. 12, 2001

(R19#26) Denonville Monument

South Face:

DENONVILLE

North Face:

1901 LOUIS J. 1951
his wife

1904 ROSALIE T. 1988
their son

1930 ROLAND E. 1945

(R19#27) Dall Monument

South Face:

DALL

North Face:

1886 HENRY J. DALL 1949

1887 EVA L. his wife 1973

1922 RICHARD S. their son 1941

(R19#28) Bouchard Monument

South Face:

BOUCHARD

In God's care

North Face:

Nov. 24, 1930

ALBERT A. "BLACKIE" BOUCHARD

Feb. 2, 1907 - Jan. 20, 1997

his wife

MARY G. BOUCHARD

Sept. 26, 1909 - Aug. 9, 2005

(R19#29)

ALBERT J FOURNIER
Maine

Pvt Co C 73 Infantry
World War I

Dec 7 1896 Dec 22 1957

Marker: U.S. Veteran

(R19#30)

Mother
YVONNE C. FOURNIER
1901 - 1975

(Note: Centered date above across 2 rings.)

(R19#31) Bernier Monument

South Face:

BERNIER

North Face:

LEON L. BERNIER

1882 - 1968

son epouse

ANTOINETTE BRASSARD

1888 - 1941

(R19#34) Schaedler Monument

SCHAEDLER

LEROY H. RITA A.

Apr. 5, 1924 Oct. 30, 1931

July 14, 1989

(R19#36) Desrosiers Monument

DESROSIERS

GERARD E. RUTH A.

1914 - 1978 1919 - 1986

(R19#38) St. Pierre Monument

ST. PIERRE

CHONG YOL

Sept. 4, 1947

Jan. 5, 1989

(R19#40) Caron Monument

CARON

ARMAND F. GRACE M.

1907 - 1970 1915 - 1974

(R19#41) NAPOLEON LACHAPELLE

1893 - 1931

(R19#42) SYLVIA P. HARVEY

1901 - 1974

Marker Stones:

(R19#32) PERE

(R19#33) MERE

(R19#35) Yakubowski Monument

North Face:

LENA

YAKUBOWSKI

February 14, 1922

May 3, 1989

South Face:

Mother of

Carl, Joe and Richard

(R19#37)

Husband

ARTHUR

BERRY

July 9, 1929 - May 28, 1955

(R19#39) Shaw Monument

North Face:

SHAW

Together forever

South Face:

GLEN P. SHAW

Sept. 1, 1922 - Nov. 26, 1997

BETTY MAGEE his wife

June 11, 1923 - Aug. 6, 2005

(R19#43)

GEORGE H. BERNIER

1882 - 1957

ANNIE B. his wife

1897 - 1994

(R19#44) Menard Monument

JOSEPH MENARD
1895 - 1951
son epouse
JOSEPHINE LABBE
1894 - 1918
MENARD

Marker: U.S. Veteran

Marker Stones:

(R19#45) VERNA A. MENARD
wife of
JOSEPH L. MENARD
June 29, 1917 Apr. 15, 1991

(R19#46) JOSEPH L MENARD
Maine
Tec 5 240 Chemical Plat
World War II
Dec 20 1912 April 21 1969

(R19#47) Bouchard Monument

JOSEPH A. BOUCHARD
1880 - 1954
ALICE M. his wife
1884 - 1951
LUDGER A. BOUCHARD
1908 - 1926
BOUCHARD

Marker Stones:

(R19#48) MOTHER

(R19#49) FATHER

(R19#50) SON

(R19#51) LAURIANNE BOUCHARD
ESTES
June 7, 1924
Jan. 5, 2006

(R19#52) Mother
MARIE
BOUCHARD

(R19#53) Moreau Monument

1835 JOSEPH MOREAU 1921
son epouse
1852 HENRIETTE 1929
1893 ARTHUR MOREAU 1918
1891 LUDGER MOREAU 1935
1883 NAPOLEON MOREAU 1962
1888 MARIE BOUCHARD 1965
MOREAU

Marker: U.S. Veteran

Marker Stones:

(R19#54) LUDGER
MOREAU
Maine
Pvt. 1 Cl. 36 Inf. 12 Div.
May 2, 1935

(R19#55) ARTHUR MOREAU
Maine
Pvt. 18 Inf. 1 Div.
October 4, 1918

(R19#56) Moreau Monument

West Face:

IHS
M
JOSEPH MOREAU fils
1879 - 1951
ses epouses
EMILIE BERNIER
1873 - 1918
CLARINA MARQUIS
1877 - 1932
ANDRIENNE MOREAU fille
1910 - 1919

Famille
JOSEPH MOREAU

East Face:

YVONNE MOREAU
1901 - 1966

(R19#60) MARIONE A. COTE TONDREAU
May 11, 1906 Jan. 1, 1988
GEORGE E. TONDREAU her son
Mar. 24, 1947

(R19#61) At rest
MURIELLE
GAUVIN
1914 - 1934
PAQUETTE

(R19#63) Moreau Monument

MOREAU
LORENZO J. MADELAINE
1892 - 1955 1914 - 1914
ROSANNA M. ALDO A.
1891 - 1971 1918 - 1929

Marker Stone:

(R19#57)

MOREAU
FLORIEN W. MOREAU
1905 - 1992
his wife
LIANE A. SIMPSON
1912 - 1999

(R19#58) Bernier Monument

BERNIER
GEORGE BERNIER
1869 - 1954
son epouse
ELIZABETH FOURNIER
1870 - 1938
EVA BERNIER
1896 - 1918
JOSEPHINE BERNIER
1891 - 1891

Marker Stone:

(R19#59)

Ici repose le corps de
WILFRID.
enfant de
GEORGE BERNIER
decedee
le 8 Oct. 1898
a l'age de 2 mois
12 jours.

(R19#62) 1887 EVA PAQUETTE 1973
wife of
1878 NAPOLEON 1959

(R19#64) Urban Monument

URBAN
LEONARD J.
Dec. 20, 1920 - Apr. 14, 2008
his wife
LOUISE IRENE MOREAU
May 2, 1924 - Nov. 7, 2006

(R19#65) Moreau Monument

MOREAU
HENRY J. IRENE L.
1894 - 1969 1889 - 1965
In loving memory

(R19#66) Thibodeau Monument

THIBODEAU IHS
EDOUARD J. THIBODEAU
May 16, 1887 - Aug. 30, 1961
his wife
MELANIE E. TREMBLEY
July 19, 1889 - Oct. 17, 1967

(R19#69) Fortin Monument

West Face:

FORTIN
ALPHONSE FORTIN
1878 - 1941
son epouse
ALEXINA DUMONT
1880 - 1920
MARIE LOUISE
1880 - 1959

East Face:

RAYMOND A. CHARRON
1911 - 1993
IRMA FORTIN
1907 - 1985
ALDEA FORTIN
1905 - 1925

Marker Stones:

(R19#67)

FRANK C BABINEAU
New Hampshire
BTGC US Navy Ret
World War II Korea
Jan 5 1906 June 26 1972

(R19#68)

EMMA BABINEAU
Mar. 29, 1909
July 18, 1995
In loving memory

Marker Stones:

(R19#70)

MARIE
LOUISE

(R19#71)

PERE

(R19#72)

MERE

(R19#73)

ALDEA

(R19#74)

RAYMOND

(R19#75)

IRMA

(R19#77) Lapierre Monument

(R19#76)

GEORGE G. LIZOTTE
Mar. 12, Sept. 6,
1937 1967

ZEPHIRIN LAPIERRE
1906 - 1933
son epouse
LAURA COULOMBE
1906 -

(R19#78) Castonguay Monument

CASTONGUAY

Husband
ANTONIO CASTONGUAY
Aug. 23, 1908 - Mar. 30, 1974

Wife
CLARA M. OUELLETTE
Mar. 10, 1904 - Sept. 17, 1958

(R19#79) Belanger Monument

West Face:

LEONIDAS BELANGER
1887 - 1956
son epouse
CEDIA MORIN
1891 - 1988
GERTRUDE
1925 - 1926

Marker: U.S. Veteran

East Face:

OCTAVE MORIN
1868 - 1929
son epouse
PHILINEE THEBERGE
1868 - 1949
THEODOSIA BELANGER
1923 -

Marker Stones:

(R19#80)	GERTRUDE
(R19#81)	THEODOSIA "La fille"
(R19#82)	WILFRED J MORIN Maine PFC Evacuation Hosp 30 World War I Oct 6 1893 July 9 1960
(R19#83)	PERE
(R19#84)	MERE
(R19#85)	CEDIA
(R19#86)	LEONIDAS

(R19#87) Fortin Monument

West Face:

JOSEPH A. FORTIN
1877 - 1922
DIANA son epouse
1878 - 1922
FORTIN

Est Face:

NAPOLEON J. FORTIN
1899 - 1952
his wife
ETTA V. CARON
1899 - 1991

Marker Stones:

(R19#88)	NAPOLEON J. FORTIN 1899 - 1952
(R19#89)	CYR ANITA A. LOUIS Apr. 8, 1914 Apr. 25, 1908 Aug. 15, 1990 Jan. 16, 1987

(R19#90) Lamarque Monument

JOSEPH LAMARQUE
1889 - 1954
son epouse
MARIE LOUISE
GAUTHIER
1889 - 1933

Marker Stones:

(R19#91)	J. ADELIA MICHAUD LAMARQUE 1903 - 1969
(R19#92)	PERE
(R19#93)	CARMELLE
(R19#94)	MERE

(R19#95) Renaud Monument
CHARLES J. RENAUD
1863 - 1931
EUGENIA M.
1879
EUGINE A.
1904 - 1923
LIONEL J.
1906 - 1910

(R19#98) Rochefort Monument
West Face:
ROCHEFORT
East Face:
AUGUSTE
1853 - 1922
OLIVA
1861 - 1937
LEO
1896 - 1960
MARY
1913 - 1994

Marker: U.S. Veteran

Marker Stones:

(R19#99) ARTHUR J MICHAUD
Pvt US Army
World War I
1895 1977

(R19#100) ROGER GAMACHE
1946 - 1980

(R19#101) DORIS A. BOURGOIN
1908 - 1960

(R19#102) ULDERIC BOURGOIN
Maine
Pvt
212 Field Sig Bn
12 Div
World War I
December 20 1896
February 26 1947

(R19#103) BOURGOIN
ARTHUR L. JEANNETTE A.
Mar. 28, 1911 Mar. 20, 1916
Dec. 28, 1977

Marker: U.S. Veteran

(R19#96) Thibeault Monument
West Face:
THIBEAULT
East Face:
PHEDIME F. THIBEAULT
1869 - 1948
son epouse
OZA FREGEAU
1869 - 1926
WILFRED J.
1900 - 1962
EMILE J. "PEPERE"
1903 - 1987
son epouse
ROSE BOUCHARD
1906

Marker Stone:
(R19#97) KATHLEEN M. THIBEAULT
Oct. 13, 1990
Our precious baby
We miss you

(R19#104) ULDERIC BOURGOIN
1872 - 1929
son epouse
MARY JANE PINETTE
1873 - 1933

(R19#105) VICTORIA McDUFF
epouse de
ULRIC COULOMBE
1873 - 1928

(R19#106) Morin Monument

MORIN
HENRI SELFRIDE
22 Aout 1883 15 Janv. 1886
2 Avr. 1958 15 Aout 1962
Dites un "Je vous salue, Marie"

Marker Stone:

(R19#107) MARIE A.
1910 - 1927

(R19#108) Lebel Monument

Ici repose le corps de
JOSEPH LEBEL
decedee le 30 Sept. 1947
a l'age de 89 ans 3 mois
son epouse
MARIE BERUBE
decedee le 22 Mai 1926
a l'age de 70 ans 2 mois
Priez pour elle
LEBEL

Marker: U.S. Veteran

Marker Stones:

(R19#109) WILFRED C LEBEL
US Navy
World War II
1925 1986

(R19#110) LAURINA LEBEL
July 27, 1902
Dec. 26, 1969

(R19#111) ANNE LEBEL
April 22, 1950
October 3, 1950
In loving memory

(R19#113) Tetreault Monument

IHS
ELOI TETREAULT
1879 - 1933
son epouse
CATHRINE OUELLETTE
1878 - 1956

(R19#112) JOSEPH P LABELLE
Maine
PFC 401 Telegraph Bn
World War I
June 22 1890 Aug 8 1950

Marker Stones:

(R19#114) ALDEA

(R19#115) ANTOINE

(R19#116) PAULINE TETREAULT BERGEN
March 1, 1917 - Dec. 29, 1966

(R19#117) GEORGE H. ST. LAURENT
born Oct. 7, 1888
died Mar. 30, 1961

(R19#118) MARY L. ST. LAURENT
born Mar. 15, 1888
died Feb. 21, 1928

(R19#119) Belanger Monument

West Face:

T. BELANGER

East Face:

BENOIT S. BLANCHETTE

1915 - 1990

his wife

ISABELLE A. LETARTE

1916 - 1947

(R19#120) Debe / Bernier Monument

North Face:

DUBE

South Face:

BERNIER

Marker Stones:

(R19#121) ALMA R. BERNIER
epouse de
ALFRED DESJARDINS
1887 - 1934

(R19#128) Moore Monument

MOORE

ELMER F. ANNA M.

Apr. 18, 1924 July 26, 1925

Apr. 6, 1998 July 24, 1997

(R19#122) JOSEPH A. DUBE
epoux de
AMANDA J. BERNIER
1884 - 1972

(R19#129) Caron Monument

West Face:

ODILON CARON

1854 - 1922

son epouse

ALICE LEBLANC

1859 - 1939

ROSE CARON

1888 - 1918

East Face:

CARON

Mon 1892 ALFRED J. CARON 1965

Jesus son epouse

1894 GEORGIANNA M. BIETTE 1996

1901 EUGENE J. CARON 1986

(R19#123) AMANDA J. BERNIER
epouse de
JOSEPH A. DUBE
1882 - 1964

(R19#124) HUSBAND - WIFE

(R19#125) Fille
MARY Z. BERNIER
1893 - 1981

(R19#126) Mere
ELMIRE BERNIER
1857 - 1938

(R19#127) Pere
CALIXTE BERNIER
1854 - 1932

(R19#130) Bernier Monument

West Face:

IHS
BERNIER
Mon Jesus misericorde

Marker Stones:

(R19#131)

Pere
JOSEPH A. BERNIER
1886 - 1971

East Face:

1886 JOSEPH A. BERNIER 1971
son epouse
1889 MARIA G. PELLETIER 1972
leur fille
1918 ANNE MARIE BERNIER 1918
1907 STANLEY F. RICHARD 1941
son epouse
1918 DENISE BERNIER
leur fils
1939 ROLAND RICHARD 1944

(R19#132)

Mere
MARIA G. BERNIER
1889 - 1972

(R19#133)

ROLAND G. RICHARD
1939 - 1944

(R19#134)

STALEY F. RICHARD
1907 - 1941

(R19#135) Menard Monument

West Face:

ADELARD MENARD
1885 - 1973
son epouse
MARY PARADIS
1887 - 1958
MENARD

South Face:

ANTOINETTE MENARD
1901 - 1918

North Face:

ODILAS MENARD
1855 - 1946
son epouse
JOSEPHINE MORIN
1860 - 1935

Marker Stones:

(R19#136)

GRAND
MERE

(R19#137)

GRAND
PERE

(R19#138)

MERE

(R19#139)

PERE

(R19#140)

ANTOINETTE

(R19#141)

DEBRA ANN HANDLEY
1961 1961

(R19#142) Castonguay Monument
IHS
C
THOMAS J. CASTONGUAY
1874 - 1918
FLORIEN CASTONGUAY
1899 - 1985
ROSA CASTONGUAY
1899 - 1989
CASTONGUAY

Marker Stone:
(R19#143) FATHER

(R19#144) Michaud Monument
CHARLES MICHAUD
1887 - 1918
son epouse
CELINA THIBEAULT
1884 -
son epoux
JOSEPH R. McDUFF
1879 - 1959
MICHAUD

Marker Stones:
(R19#145) EPOUX

(R19#146) JOSEPH R. McDUFF
1879 - 1959

(R19#147) Baribault Monument
West Face:

BARIBAULT

East Face:
1883 ERNEST 1973
1888 IRMA 1918
1908 LILLIAN 1991
1915 LIONEL 1915
1927 DONALD 1927
1944 ELAINE PROVENCHER 1944

(R19#148) Brillant Monument

West Face:
BRILLANT

East Face:
J. HELEODORE BRILLANT
Oct. 3, 1918 - Aug. 11, 1998
beloved wife
LORETTE LeBOURDAIS BRILLANT
Sept. 30, 1922 -

Marker: U.S. Veteran

(R19#149) Bernier Monument
West Face:

BERNIER

East Face:
1864 JOSEPH BERNIER 1951
son epouse
1871 CATHERINE DEROCHER 1935
1910 AGATHE BERNIER 1998

Marker Stones:
(R19#150) MERE
(R19#151) PERE
(R19#152) AGATHE

(R19#153) Bouchard Monument
West Face:

BOUCHARD
XAVIER F.
1889 - 1923
son epouse
MARIE A. LEVESQUE
1889 - 1949

East Face:
1915 LILLIAN E. 1919
1913 EMILE A. 1982
1918 ROSE ANNA 1997

Marker Stones:

(R19#154)

EMILE

(R19#155)

ROSE

(R19#156)

MARIE ANNE BOUCHARD
1889 - 1949

(R19#157)

XAVIER F. BOUCHARD
1889 - 1923

(R19#158)

(LILLIAN) E. BOUCHARD
(1915) - 1919

(Note: Undertaker Marker with
letters and numbers missing.)

(R19#159) Michaud Monument

West Face:

MICHAUD
Say a Hail Mary

East Face:

THOMAS E. MICHAUD
Sept. 8, 1895 - Oct. 10, 1960
his wife
YVONNE BOUCHARD
Aug. 26, 1900 - Jan. 23, 1982

Marker: U.S. Veteran

Marker Stones:

(R19#160)

GEORGE E MICHAUD
son of
THOMAS and YVONNE
Sept 6 1925 Sept 29 1998

(R19#161)

YVONNE BOUCHARD MICHAUD
wife of
THOMAS E MICHAUD
Aug 26 1900 Jan 23 1982

(R19#162)

THOMAS E MICHAUD
Maine
Cpl Co 1 39 Infantry
World War I
Sept 8 1895 Oct 10 1960

(R19#163) Cote Monument

COTE

LOUIS P. LAURIANNE M.
1922 - 1921 - 2004
St. Jude pray for us

(R19#164) Brillant / Mercier Monument

West Face:

BRILLANT
MERCIER
In
God's
care

East Face:

OMER E. MERCIER
Sept. 10, 1911 - Sept. 11, 2001
his wife
ANNETTE M. BRILLANT
Feb. 17, 1920 - Aug. 26, 1997

Marker: U.S. Veteran

(R19#165) Leclair Monument

LECLAIR
PHILIP P. LECLAIR
23 Fev. 1879 - 27 Juin 1959
son epouse
ALEXINA A. TONDREAU
27 Juil 1880 - 17 Juil 1967
Dites "je vous salue, Marie"

Marker Stones:

(R19#166) **CECILIA G. LECLAIR**
June 27, 1912 May 11, 1992

(R19#167) **MERE**

(R19#168) **PERE**

(R19#169) **JEANNETTE E. LECLAIR**
June 2, 1905 May 17, 1992

(R19#170) Brillant Monument

BRILLANT
1882 **ALBERT J.** 1952
1884 **MARIE B.** his wife 1971

Marker Stones:

(R19#171) **L. J. SAUCIER**
1913 - 1941

(R19#173) **MOTHER**

(R19#172) **FATHER**

(R19#174) **JOHN F. GALLANT**
1903 - 1971
CECILE B. his wife
1913 - 1994

(R19#175) Paradis Monument

West Face:

JOSEPH Z. PARADIS
1862 - 1938
son epouse
EVA PARADIS
1870 - 1952
PARADIS

East Face:

OSCAR F. PARADIS
1902 - 1987
son epouse
REGINA
1907 - 1987

(R19#176) Keough Monument

West Face:

KEOUGH

East Face:

GWENDOLYN GARVIN KEOUGH
July 20, 1938 Dec. 1, 1987
beloved wife of
JAMES E. KEOUGH

(R19#177) LeClair Monument

West Face:

LECLAIR

East Face:

AIME M. LeCLAIR
1875 - 1949
his wife
ROSANNA LABBE
1880 - 1922

Marker Stone:

(R19#178)

IHS
Mother
LEA,
wife of
MICHEL LECLAIR
1848 - 1918

(R19#179) Pouliot Monument

West Face:

IHS
EDMOND POULIOT
1861 - 1923
son epouse
APOLINE LABBE
1869 - 1933
JEAN P. POULIOT
1902 - 1945
POULIOT

Marker Stones:

(R19#180) (Blank)
(R19#181) JEAN
(R19#182) MERE
(R19#183) PERE

East Face:

ALPHONSINE POULIOT
1893 -

(R19#185) FRANCIS G. BEAUREGARD
1940 - 1941

(R19#184) Thibodeau Monument

THIBODEAU
1851 DAMIEN 1923
1880 SEVERIN 1931
his wife
MARIE LOUISE
1889 1972
1914 GERMAINE 2002
Jesus Mary Joseph

(R19#186) Keough Monument

KEOUGH Jesus
JAMES E. Sr. Mary
1917 - 1985 Joseph

(R19#187) CHARLES T. LAFFELY
June 13, 1935
July 31, 1985

(R19#188) ROSE J. LAFFELY

Dec. 7, 1922
Sept. 5, 1993

(R19#189) CHANEL P ALLARD
PFC US Army
Jan 13 1931 Aug 2 2003

(R19#190) Schinck Monument

IHS
ZEPHERIN SCHINCK
1890 - 1923
son epouse
BERTHA LABBE
1891 - 1932
son fils
GERARD SCHINCK
1914 - 1936
SCHINCK

(R19#191) St. Pierre Monument

West Face:

ST. PIERRE
Jesus, Marie et Joseph

East Face:

HILAIRE J. ST. PIERRE
Nov. 9, 1888 - June 12, 1955
epoux de
ELIZABETH FOURNIER
Aug. 26, 1888 - Nov. 18, 1959
VIOLET C. ST. PIERRE
Dec. 24, 1921 - Nov. 1, 1925
GERALD R. ST. PIERRE
Mar. 2, 1924 - May 31, 1994
MARY M. ST. PIERRE
Dec. 12, 1927 -

Marker Stones:

(R19#192) HILAIRE
ST. PIERRE
1888 - 1955

(R19#193) ELIZABETH
ST. PIERRE
1888 - 1959

(R19#194) GERALD R.
ST. PIERRE
1924 - 1994

(R19#195) MARY M.
ST. PIERRE
1927 -

(R19#196) VIOLET C.
ST. PIERRE
1921 - 1925

(R19#197) Allard / Laffely Monument

West Face:

ALLARD
LAFFELY

East Face:

CHANEL P. ALLARD
Jan. 13, 1931 Aug. 2, 2003
EVA S. LAFFELY his wife
Oct. 4, 1932
CHARLES T. LAFFELY her brother
June 13, 1935 July 31, 1985
ROSE J. LAFFELY his sister
Dec. 7, 1922 Sept. 5, 1993

Marker: U.S. Veteran

(R19#198) Schinck Monument

West Face:

SCHINCK
Dites un "je vous salue, Marie"

East Face:

17 Juin 1892 LEONARD G. SCHINCK 5 Mars 1957
son epouse
19 Juil. 1902 GERMAINE Y. ST. PIERRE 3 Janv. 1981

Marker Stone:

(R19#199) Top of stone:
MERE
Face of stone:
ALMA LABBE
epouse de
LEON SCHINCK
1890 - 1927

(R19#200) ANITA ROBINSON
Jan. 1, 1946

(R19#201) GEORGE &
GEORGETTE
ROBINSON
died Apr. 16, 1942

(R19#202) ROBINSON
CARL D. DOROTHY A.
Dec. 11, 1916 Feb. 9, 1919
Jan. 9, 1983

(R19#203) Benoit Monument

East Face:

LOUIS J. BENOIT
1864 - 1931
EMMA J. his wife
1871 - 1946
BENOIT

West Face:

JOSEPH A. BENOIT
1837 - 1927
ERNEST F. BENOIT
1895 - 1947
MARY A. his wife
1902 - 1957

Marker Stones:

(R19#204) ERNEST F.
(R19#206) JOSEPH A. BENOIT
1837 - 1927
(R19#208) VITAL A. OUELLETTE
1899 - 1991

(R19#205) MARY A.
(R19#207) FATHER
(R19#209) ARLENE L. his wife
1902 - 1992

(R19#210) MOTHER

(R19#211) Baribeau Monument

West Face:

BARIBEAU

Priez pour nous, sante mere de dieu

East Face:

1891 ALPHONSE J. BARIBEAU 1955
son of MICHEL
his wife
1880 ADELIA LABBE
son
1914 ARMAND BARIBEAU 1918
1841 MICHEL BARIBEAU 1923
1932 ROBERT A. BARIBEAU 1938
son of HENRY and LUCILLE

(R19#212) Caron Monument

West Face:

CARON

epoux

EDOUARD H. CARON

7 Oct. 1884 - 2 Juin 1960

epouse

MARIE ANNE CLOUTIER

23 Janv. 1883 - 25 Avril 1978

Dites nous un "je vous salue, Marie"

East Face:

1908 FREDERIC E. FORTIN 1983

his wife

1911 EMILIENCE F. CARON 1995

Marker Stones:

(R19#213) MARIE ANNE ALINE

(R19#214) EDOUARD
CARON

(R19#215) MARIE ANNE
CLOUTIER

(R19#216) Ruest Monument

RUEST

JOHN RUEST

19 Aout 1887 - 13 Dec. 1961

son epouse

WILMA BOURGOIN

1 Fev. 1898 - 16 Mars 1978

Dites nous un "Je vous salue, Marie"

Marker Stone:

(R19#217) JOHN RUEST
Maine

PFC US Army
World War I

Aug 19 1887 Dec 13 1961

(R19#218)

Ici repose le corps de

CHARLES DANIEL

epoux de ERMINE TREMBLEY

ne a Lislet P.Q. et

decede a Brunswick, Me.

le 2 Fevrier 1911

a l'age de 59 ans 7 mois et 5 jours

(R19#219) Nadeau Monument

West Face:

NADEAU

Jesus Marie Joseph

East Face:

1892 NAPOLEON NADEAU 1994
ses epouses

1891 MARIE L. LAVOIE 1918

1891 AUGUSTINE GAGNON 1966

1917 MARCEL LANGLAIS 1922

1867 ODELIE LACHANCE 1942

(R19#220) McElhinny / Ouellette Monument

East Face:

McELHINNY	
Husband	Wife
BERNARD V.	MARIE SOPHIE
1926 1977	1923

West Face:

OUELLETTE		
Husband	Wife	Son
ANDRE P.	DELIA	SIMIONE
1875 1962	1882 1937	1902 1918

Marker: U.S. Veteran

Marker Stone:

(R19#221) BERNARD V McELHINNY
S1 US Navy
World War II
1926 1977

(R19#222) Menard Monument

West Face:

MENARD

East Face:

JEAN B. MENARD	WILLIAM BARD
1890 - 1954	1869 - 1941
AGNES his wife	his wife
1896 - 1961	JOSEPHINE S.
FRANCOISE	1871 - 1947
1917 - 1917	IRENEE J. DOYON
JOSEPH	1923 - 1991
1942 - 1942	OLIVETTE A.
	1923

(R19#224) Pelletier Monument

P

En memoire de
ALFRED PELLETIER
1859 - 1945
son epouse
OLIVA MICHAUD
1856 - 1920
R.I.P.
PELLETIER

Marker Stones:

(R19#225) MARIE ANNA
1892 - 1976

(R19#223) Bernier Monument

West Face:

BERNIER

1904 ROSE-ANNA BERNIER 1994

East Face:

1878 EDMOND BERNIER Sr. 1963
his wife
1877 VIRGINIA ST. PIERRE 1961
1900 EDMOND BERNIER Jr. 1977
1910 M. LEONIE BERNIER 1931

(R19#226) THEODORA M.
1897 - 1960

(R19#227) PERE

(R19#228) MERE

(R19#229) EUGENIE
epouse de JOSEPH
1889 - 1960

(R19#230) Fils
JOSEPH
1888 - 1955

(R19#231)

ALLARD
In God's care

(R19#232) FRANK
LOVETT
Maine
Pvt. 302 Inf.
76 Div.
April 14, 1919

(R19#233) Paquette Monument
West Face:
IHS
AMBROISE PAQUETTE
1839 - 1919
MALVINA JEAN
son epouse
1844 - 1927
PAQUETTE
East Face:
ERNEST 1881 - 1931

(R19#234) Brillant Monument
West Face:

BRILLANT
Notre que
pere votre
qui etes nom
aux soit
cieux sanctifie

epouse epoux
MARIE A. BOIS WILLIE BRILLANT
27 Fev. 1891 22 Nov. 1888
2 Mai 1959 7 Juin 1978

East Face:

Enfants
17 Fev. 1920 ANNETTE
3 Janv. 1931 EMILIEN 27 Sept. 1931
5 Mai 1932 LUCIEN
10 Juin 1933 JEAN PAUL 30 Juil. 1933

Granite Plaque:

A notre
chere
maman

Marker Stones:

(R19#235) DORIS BRILLANT
epouse de
J. ADELARD CAOUCETTE
nee 29 Aout 1916
decede 8 Mai 1950

(R19#236) JEAN PAUL
BRILLANT

(R19#237) MERE

(R19#238) PERE

(R19#239) EMILIEN
BRILLANT

(R19#240) Laberge / Brillant Monument

LABERGE
BRILLANT
In loving memory

Marker Stones:

(R19#241) ERNEST
LABERGE
1880 - 1906

(R19#242) EUGENIE
BRILLANT
1883 - 1963

(R19#243) LIONEL LABERGE
June 5, 1905
Jan. 24, 1966

(R19#244) CLAIRE LABERGE
April 7, 1912
July 5, 1999

(R19#245) Cloutier Monument

West Face:

CLOUTIER
JOSEPH CLOUTIER
nee en 1852, decede en 1923
son epouse
ANASTASIE BOULE
nee en 1850 decedee en 1932
MARIE LOUISE CLOUTIER
nee en 1909, decedee en 1921

East Face:

MARIE B. CLOUTIER
nee en 1888 decede en 1934
ADELARD F. CLOUTIER
1884 - 1948

Marker Stones:

(R19#246) ADELARD
(R19#247) MARIE B.
(R19#248) MARIE L.
(R19#249) PERE
(R19#250) MERE

(R19#251) Lamarque / Dumais Monument

LAMARQUE
DUMAIS

Marker Stones:

(R19#252) DOMINIQUE ST. PIERRE (R19#253) Mere
4 Auot 1862 - 2 Dec. 1955 MATHILDE D. DUMAIS
son epouse 1845 - 1929
ERNESTINE DUMAIS
13 Juin 1871 - 12 Fev. 1954 (R19#254) Pere
OCTAVE DUMAIS
1845 - 1926

(R19#255) LEONIE HENRY J.
Oct. 16, 1881 Aug. 18, 1885
Sept. 5, 1970 Mar. 14, 1961

(R19#256) THOMAS M. GAMACHE
1888 - 1933
son epouse
ALMA FOURNIER
1890 - 1983

(R19#257) GAMACHE
NOELLA M. GEORGE A.
Dec. 21, 1912 June 23, 1913
July 6, 2007 Oct. 7, 1994

(R19#258) Masse Monument

West Face:

MASSE

East Face:

LUDGER MASSE

1871 - 1923

son epouse

ELIDA OUELLETTE

1879 - 1950

U. LORENZO MASSE his wife LIANE

1903 - 1962 1908 - 1990

MADELEINE M.

1910 - 2001

Marker Stones:

**(R19#259) LIANE
nee OUELLETTE**

(R19#260) LORENZO

(R19#261) MERE

(R19#262) PERE

(R19#263) MADELEINE

(R19#264) Tremblay Monument

TREMBLAY

1862 CHARLES 1932

son epouse

1870 ANNABELLE 1946

1911 ALBERT 1922

daughter

1896 DIANA 1972

Marker Stones:

(R19#265) FRANK TREMBLAY

-

Maine

-

Pvt., 301 Engrs. 76 Div.

June 30, 1930

**Marker: Veterans of Foreign Wars
of the United States**

(R19#267) Brassard / Lamarre Monument

West Face:

FRANCOIS BRASSARD

1844 - 1898

GEORGIANA son epouse

1855 - 1921

filles

CLAUDIA B. THIBEAULT

1879 - 1964

EMELIA BRASSARD

1894 - 1985

BRASSARD

East Face:

dau. of CLAUDIA

ANNIE I. THIBEAULT

1903 - 1998

ROSAIRE L. LAMARRE

1937 - 2000

his wife

ROLANDE T. ALLEN

1941 -

LAMARRE

**(R19#266) GERMAINE M. ROY
1927 - 1929**

Marker Stones:

(R19#268) CLAUDIA

(R19#269) MERE

(R19#270) Menard Monument

West Face:

MENARD
FABIEN
1887 - 1966
son epouse
YVONNE
LANGEVIN
1892 - 1941
MARIE
1918 - 1918
GERMAINE
1925 - 1925
MENARD

South Face:

ALICE
LEVESQUE
1886 - 1959

Marker Stones:

(R19#271) (Blank)

(R19#272) PERE

(R19#273) ALICE

(R19#274) MERE

(R19#275) Labbe Monument

West Face:

LABBE
THOMAS LABBE
1896 - 1940
epoux de
MARIE-LOUISE COTE
1900 -
1925 THOMAS Jr. 1925

East Face:

ZEPHIRIN LABBE
1863 - 1926
epoux de
DELIA LEMIEUX
1858 -

Marker Stone:

(R19#276) ZEPHIRIN LABBE
decede le 16 Jan. 1926
age 63

(R19#277) Lavoie Monument

West Face:

JOSEPH P. LAVOIE
son epouse
JUSTINE ST. PIERRE
1865 - 1925
enfant children
ELZEAR 1889 age de 17 mos.
MARIE 1896 age de 5 mos.
THELESFORT 1896 age de 5 mos.
LAVOIE

Marker Stones:

(R19#278) MERE

(R19#279) ALPHONSE
27 Dec. 1897
25 Aout. 1943

East Face:

TURCOTTE

(R19#280) Laffely Monument

West Face:

LAFFELY

East Face:

1873 CHARLES LAFFELY 1938
 son epouse
 1878 HELENE TREMBLAY 1924
 1899 LOUIS J. LAFFELY 1950
 son epouse
 1900 ROSE MARTIN 1951
 1925 LOUIS R. LAFFELY 2002
 son epouse
 1928 MARIE A. LABBE 2005

Marker Stones:

(R19#281) LOUIS
 (R19#282) PERE
 (R19#283) MERE
 (R19#284) LOUIS G. LAFFELY
 April 20, 1955
 December 2, 2007
 (R19#285) LOUIS R.
 (R19#286) MARIE A.
 (R19#287) ROSE

(R19#288) Marois / Lebel Monument

West Face:

ELZEAR MAROIS
 1855 - 1927
 son epouse
 ANNA BERGER
 1858 - 1944

East Face:

ARTHUR LEBEL
 1881 - 1944
 BERTRAND
 1913 - 1947

(R19#289) Labbe Monument

West Face:

LABBE

East Face:

1879 ONESIME LABBE 1959
 1879 DIANA T. his wife 1931
 1904 CECILE daughter 1940
 1906 EVALEDA M. 1989
 1909 JULIETTE M. 1987

(R19#294) Labbe / Charron Monument

West Face:

CALIXTE LABBE
 1879 - 1934
 son epouse
 OLIVE CHARRON
 1876 - 1940

East Face:

SHARLE CHARRON
 1855 - 1937
 son epouse
 ADELAIDE RENEAUD
 1858 - 1932
 ELIE leur fils
 1886 - 1964
 LEVI CHARRON
 1889 - 1961

Marker Stones:

(R19#290) EVALEDA
 (R19#291) DIANA
 (R19#292) ONESIME
 (R19#293) JULIETTE

(R19#295) Richard Monument

NAPOLEON RICHARD
 1892 - 1934
 EVA GARON son epouse
 1892 - 1981
 LAURENTINE leur fille
 1914 - 1932
 RICHARD

Marker Stones:

(R19#296) LAURENTINE

(R19#297) PERE

(R19#298) MERE

(R19#299) TELESPORE
1893 - 1980
son epouse
MARY Z. SCHINCK
1896 - 1964
FAVREAU

(R19#300) AMEDEE
1861 - 1941
son epouse
ARZELIE BENOIT
1861 - 1958
FAVREAU

(R19#301) Top of stone:
ROLAND P.
Face of stone:
fils de
T. A. & M. Z. FAVREAU
Mar. 1, 1917
Apr. 19, 1917.

(R19#302) En memoire de
RODOLPHE L. FAVREAU
ne le 12 Fevrier 1925
tue au combat dans le Pacifique
le 2 Avril 1945

(R19#303) Top of stone:
MARIE NOELA
Face of stone:
dau. of
H. & E. LEBEL
age 5 mos.

(R19#304) GERARD C.
son of
D. L. FAVREAU
Apr. 29, 1921
Nov. 16, 1921

(R19#305) Caron Monument

EUGENIE	CARON	ODELA
1905 - 1991	GEORGE	1925 - 1977
	1905 - 1972	

Marker Stones:

(R19#306) LABBE
ODILA EUGENIE
1884 - 1943 1884 - 1932

(R19#307) SALOME ST. PIERRE
wife of
LOUIS LEVESQUE
1858 - 1930

(R19#308)

IHS
A
ONESIME BELANGER
decede 7 Janvier 1917
a l'age de 56 ans
son epouse
ANASTASIE MENARD

(R19#312) Morin Monument

West Face:

MORIN
ALCIDE J.
May 27, 1900 - Feb. 13, 1956
son epouse
YVETTE
Aug. 14, 1906 - Aug. 16, 1994

East Face:

decede
1864 NESTOR MORIN 1918
1871 DELINA MORIN 1929
1889 LORENZO MORIN 1922

(R19#316) Fortin Monument

West Face:

ROMUALD FORTIN
1862 - 1933
son epouse
VITALINE
GAMACHE
1860 - 1923
MARGARET
FORTIN
1889 - 1941
FORTIN

East Face:

JOSEPH
GUILMETTE
1882 - 1934

Marker Stones:

(R19#317) J. GUILMETTE

(R19#319) CECILE F. LAVOIE
1892 - 1972

(R19#309) Menard Monument

West Face:

ZEPHIRIN MENARD
1857 - 1917
ADELE RODRIGUE
son epouse
1860 - 1933
MENARD

South Face:

WILBROD MENARD
1892 - 1951

Marker Stones:

(R19#310) ANATHOLE

(R19#311) WILBROD

(R19#313) Lavigne Monument

LAVIGNE
CHARLES G. LAVIGNE

ALICE EMOND

son epouse
1873 - 1918
GEORGE G. ST. PIERRE
1889 - 1959
CAMILLE L. his wife
1895 - 1972

Marker Stones:

(R19#314) MERE

(R19#315) WHITE
CHARLES F. EGLANTINE L.
1907 - 2000 1908 - 2001

(R19#318) MARIE A. G. BERUBE
1887 - 1965

Marker Stones Cont'd.:

(R19#320)

JOSEPH L LAVOIE
Maine
Pvt Co C 36 Infantry
World War I
April 28 1892 March 9 1959

(R19#321) Dubreuil Monument

West Face:

DUBREUIL
1882 ALFRED 1937
1895 LAURA 1950

East Face:

1861 AMARILO DUBREUIL 1932
1919 ROBERT DUBREUIL 1919
1916 MARIE ANN DUBREUIL 1919
1890 ERNEST GAGNE 1960
1896 ROSE GAGNE 1954
1938 DAVID GAUDREAU

Marker Stones:

(R19#322)

ERNEST GAGNE
Maine
Pvt 44 Co 151 Depot Brigade
World War I
Nov 9 1890 Jan 10 1960

(R19#323)

ROSE GAGNE
1897 - 1954

(R19#324)

MARIE ANNA DUBREUIL
1916 1919

(R19#325)

ROBERT DUBREUIL
1919 1919

(R19#327) Helie Monument

West Face:

IHS
JOSEPH HELIE
1869 - 1937
son epouse
MARIE LEPAGE
1871 - 1949
HELIE

East Face:

JOSEPH I. HELIE
1905 - 1984
son epouse
SIMONE N. DUBE
1907 - 1966
1927 IRENEE J. HELIE
son epouse
1926 GEORGETTE M. MICHAUD

(R19#326)

AMARILDA CHENARD
1861 - 1932
epouse de
ULDERIC DUBREUIL

Marker Stones:

(R19#328) PERE

(R19#329) MERE

(R19#330) SIMONE

(R19#331) JOSEPH

(R19#332)

ANTOINE A. COUILLARD
Nov. 11, 1910
Oct. 6, 1986

(R19#333)

ATHALA E. COUILLARD
wife of ANTOINE
Feb. 21, 1919
Feb. 21, 1978

(R19#334) Soeur
LUCIE COUILLARD
Oct. 22 June 6
1882 1919
Mon Jesus misericorde

(R19#335) COUILLARD
Epouse Epouse
AMANDA L. NAPOLEON J.
4 Juil. 1885 - 23 Fev. 1965 8 Mars 1884 - 18 Mars 1973
Mon Jesus misericorde

(R19#336) Berube Monument

IHS
B
FERDINAND
BERUBE
1859 - 1929
son epouse
EMMA GODBOUT
1863 - 1949
HORMIDAS
BERUBE
1897 - 1919
BERUBE

Marker Stones:

(R19#337) CLAIRE B.
BERUBE
1902 - 1988

(R19#338) ARTHUR F.
BOUCHARD
1902 - 1971

(R19#339) VERIAN L. BEEBE
Jan. 12, 1934
HELEN M. BEEBE
Feb. 27, 1935

(R19#340) Dionne Monument

DIONNE
1858 ERNEST Sr. 1939
son epouse
1863 JULIA 1920
1896 WILFRED J. 1944
son epouse
1897 MARIE ANNA 1989

Marker Stones:

(R19#341) PERE

Marker: U.S. Veteran

(R19#342) MERE

(R19#343)

LACHANCE

Epouse
CLARISSE LABERGE
22, Aout 1906
6, Janv. 1965

Epoux
ANTOINE LACHANCE
14, Juin 1905
27, Juil. 1970

(R19#344)

LARBERGE

Epoux
ALBERT LARBERGE
23 Aout 1878
23 Sept. 1958

Epouse
MARIE J. MARQUIS
14 Juil 1880
19 Janv. 1962

(R19#345) GEORGE MARQUIS
1856 - 1941

(R19#346) HENRIETTE MARQUIS
1855 - 1940

(R19#347) Brochu Monument

West Face:

IHS
BROCHU
In loving memory

East Face:

1914 RAOUL J. BROCHU 1980
his wife
1916 CLAIRE FORTIN 1973
1886 JEAN B. FORTIN 1943
his wife
1887 AMANDA LABEL 1920
1908 CECILE FORTIN 1932

(R19#348) Dube Monument

ULRIC DUBE
1868 - 1920
son epouse
AMANDA
ST. PIERRE
1874 - 1944
enfant
HENRI DUBE
decede le
23 Juillette 1902
DUBE

Marker Stones:

(R19#349) PHILIP DUBE
1900 - 1983
ALICE LAVIGUEUR
his wife
1899 - 1999

(R19#350) STEPHEN B. DUBE
July 19, 1958
Jan. 8, 1980
... so much love

(R19#351) DAVID D. DUBE
1929
CAROL BARNES DUBE
his wife
1929

(R19#352) PERE

(R19#353) MERE

(R19#354) MAURICE G. DUBE
March 21, 1938
Dec. 31, 1938

(R19#355) Labbe Monument

West Face:

LABBE
Que votre
volonte soit faite

Marker Stones:

(R19#356)

OVILA
1908 - 1921

East Face:

1882 DIEUDONNE LABBE 1963
son epouse
1880 DEMERISE CAOUETTE 1968
enfants
1908 OVILA LABBE 1921
1913 ADRIEN LABBE 1984
1917 LILLIAN LABBE 2005
1916 RUSSELL CHASE 1994

(R19#357) RUSSELL C. LILLIAN LABBE
CHASE CHASE
1916 - 1994 1917 - 2005

(R19#358)

MERE
1880 - 1968

(R19#359)

PERE
1882 - 1963

(R19#360)

ADRIEN
1913 - 1984

(R19#361) Vermette Monument

VERMETTE

LUCIEN A. Married YVONNE R.
1905 - 1983 Sept. 30 1910 - 1999
1929

(R19#362) Therrien Monument

West Face:

THERRIEN

East Face:

1886 EDMOND P. THERRIEN 1971
son epouse
1892 DELIA MENARD 1941

(R19#363) Lowell Monument

West Face:

JOSEPH LOWELL
died Aug. 20, 1921
age 57 years
LOWELL

Marker Stones:

(R19#364) JOSEPH

(R19#365) WILLIAM

East Face:

1860 WILLIAM LOWELL 1930

(R19#366) Bernier / LaBrecque Monument

BERNIER
LaBRECQUE
ZEPHERIN BERNIER
1847 - 1921
AGLEE GUIMOND (his wife)
1857 - 1926
J. ADELARD A. BERNIER
1936 - 1937 (infant - 4 mos.)
AMEDEE BERNIER
1877 - 1936
LUCIEN V. LaBRECQUE
1899 - 1942
BLANCHE BERNIER (his wife)
1891 - 1960
EDWARD A. BERNIER
1892 - 1971

Marker Stones:

(R19#367) MERE
(R19#368) PERE
(R19#369) EDWARD A. BERNIER
1892 - 1971
(R19#370) BLANCHE BERNIER
his wife
1891 - 1961
(R19#371) LUCIEN V. LaBRECQUE
1899 - 1942

(R19#372) Lavoie Monument

West Face:

LAVOIE

East Face:

LETUS LAVOIE
1862 - 1929
son epouse
ARTHEMISE LABEL
1868 - 1928
JOSEPH O. LAVOIE
1892 - 1966
son epouse
ALICE L. LECLERC
1893 - 1952

(R19#373) Livernois Monument

IHS
DOLOR LIVERNOIS
1874 - 1951
son epouse
FLARENDEZ DEMERS
1879 - 1939
LIVERNOIS

Marker Stones:

(R19#374) LIVERNOIS
OLIVER BEATRICE
1902 - 1986 1895 - 1979
In loving memory

(R19#375) FLORINDY M.
LIVERNOIS
1879 - 1939

(R19#376) GERALD F. McNEIL
1937 1939

(R19#377) Our baby JOEL
beloved son of Mr. & Mrs.
ROSAIRE LIVERNOIS
1940 - 1941

(R19#378) Lemieux Monument

West Face:

ALFRED LEMIEUX
1867 - 1924
son epouse
JOSEPHINE TARDIF
1863 - 1937

East Face:

JOSEPH LEMIEUX
1891 - 1967
son epouse
EUGENIE GUIMOND
1896 - 1961

Marker Stones:

(R19#379) PERE

(R19#380) MERE

(R19#381) EPOUSE

(R19#382) JOSEPH

(R19#383) Dagenais Monument

West Face:

IHS
DAGENAIS
WALTER DAGENAIS
1866 - 1926
son epouse
CLEMENCE COULOMBE
1869 - 1936
ALBERT P.
1903 - 1929

East Face:

EDGAR 1902 - 1902
EDWARD 1904 - 1904
EMILIEN 1905 - 1905
JOSEPH 1911 - 1924

(R19#384) Dionne Monument

LUDGER DIONNE
1887 - 1934
VIRGINIA PICHE
1885 - 1968
1911 ARTHUR 1930
1923 RITA 1946

Marker Stones:

(R19#385) EDWARD R DIONNE
Tec 5 US Army
World War II
Jun 11 1919 Jul 28 2005
Your whole family loves and
misses you very much

Marker: U.S. Veteran

(R19#386) ANNA C. DIONNE
1916 - 1973

(R19#387) ADAM J AUBE
PFC US Marine Corps
Nov 12 1987 Sep 9 2006
Beloved son and brother

Marker: U.S. Veteran

(R19#388) Johnson Monument

ROBERT C. JOHNSON

1915 - 1931

LAURA G. JOHNSON

1897 - 2000

JOHNSON

Marker Stones:

(R19#389)

ROBERT C.

(R19#390) 1863 **GEORGE GAUDREAU** 1954
his wife

1868 **DEMERISE FOURNIER** 1938
daughter

1906 **DELIA GAUDREAU** 1950

(R19#392) Derocher Monument

West Face:

DEROCHER

Jesus Marie Joseph

East Face:

1879 **WILLIE DEROCHER** 1972
son epouse

1879 **HELENE FORTIN** 1961
filles

1909 **ROSE DEROCHER** 1994

1918 **RITA GIRARD** 2001

(R19#391)

RUTH M. AUCOTT

1919 - 1990

Marker Stones:

(R19#393)

JACQUES 1931

RONALD 1932

fil enfant de

FAYDA & DELIA BISSON

(R19#394) Marquis Monument

East Face:

MARQUIS

Jesus Mary and Joseph

West Face:

1895 **JOHN B. MARQUIS** 1985
his wife

1897 **EXILIA BOUCHARD** 1968

1919 **Baby LAURIANNE** 1919

1923 **Baby GEORGETTE** 1923

1918 **RAYMOND MARQUIS** 1994

Marker Stones:

(R19#395)

Son

RAYMOND MARQUIS

1918 - 1994

(R19#396)

Father

JOHN B. MARQUIS

1895 - 1985

(R19#397)

Mother

EXILIA BOUCHARD

1897 - 1968

(R19#398)

In repose le corpse de
THOMAS E. CARON
decede le 28 Mars 1916
a lage de 53 ans 8 mois
priez pour lui
son epouse

ANGELINA LECLERC

decede le 1 Juin 1942

a lage de 75 ans 10 mois

(R19#399)

HENRIETTE P. CARON

wife of

JOSEPH E. CARON

Aug. 31, 1896 Oct. 14, 1986

(R19#400)

JOSEPH E CARON
Pvt US Army
World War I
Apr 15 1894 Oct 17 1975

Marker: U.S. Veteran

(R19#401)

1898 - 1966
ANTONIO CARON

(R19#402)

CHARLES J. PINETTE
1890 - 1961
ERNESTINE L. PINETTE
1897 - 1994

(R19#403)

EVANO PINETTE
1881 - 1946

(R19#405)

PIERRE PINETTE, Jr.
1868 - 1927

(R19#404)

PIERRE PINETTE, Sr.
1846 - 1916
ODELIE PINETTE
1850 - 1920

(R19#406) Michaud Monument

West Face:

IHS
A la douce
memoire de
JOSEPH MICHAUD
1865 - 1915
epoux de
LEDA COTE
1864 - 1937
MICHAUD

North Face:

HONORE MICHAUD
1835 - 1908
Pere de JOSEPH

Marker Stones:

(R19#407)

MERE

(R19#408)

MICHAUD
Jesus Marie Joseph
JOSEPH H. JOSEPHINE E.
1892 - 1966 1894 - 1989

(R19#409)

ADOLPHE H.
MICHAUD

-

Maine

-

Pvt. 1 Cl. 317 Field
Sig. Bn. 92 Div.
October 8, 1932

(R19#412) Letarte Monument

West Face:

LETARTE

East Face:

1813 ALEXIS LETARTE 1990
his wife
1914 LILLIAN GAGNON 1997

Marker: U.S. Veteran

(R19#410)

GRAND PERE

(R19#411)

PERE

Marker Stones:

(R19#413) ABEL A. LETARTE
born died
Jan. 9 April 3
1938

(R19#414) ALEXIS P. LETARTE
1887 - 1921

(R19#415) EMMA BELANGER
epouse de
ALEXIS P. LETARTE
1885 - 1916

(R19#416) Bouchard Monument

West Face:

In
God's BOUCHARD
care

Marker Stones:

(R19#417) Soeur
LORETTA
BOUCHARD
1931 - 1940

East Face:

JOSEPH BOUCHARD
1873 - 1950
EMMA TETREAULT his wife
1874 - 1916

(R19#418) ANITA M. BERNIER
June 23, 1930
June 28, 1930

(R19#419) JOSEPH
BOUCHARD
1873 - 1950

(R19#420) REBECCA
COULOMBE
epouse de
EDDY BOUCHARD
1905 - 1933

(R19#421) Pere
EDOUARD
BOUCHARD
1898 - 1947

(R19#422) EMMA
TETREAULT
epouse de
JOSEPH BOUCHARD
1874 - 1916

(R19#423) A la douce memoire
EDOUARD
fils de
ELZEAR & JOSEPHINE BRILLANT
decede le 31 Janvier 1916
a l'age de 2 ans 2 mois

(R19#424) BRILLANT
ELZEAR E.
Nov. 10, 1904
July 28, 1985

(R19#425) LIONEL N BRILLANT
US Army
World War II
Dec 25 1919 Mar 28 2005

(R19#426) JOSEPHINE C. BRILLANT
1881 - 1979
ELZEAR BRILLANT
1873 - 1927

Marker: U.S. Veteran

(R19#427) A la douce memorie de
ELZEAR BRILLANT
epoux de
JOSEPHINE CHOUINARD
decede
le 21 Feb. 1927
a l'age de 54 ans 10 mois

(R19#430) Deschenes Monument

West Face:

DESCHENES
1904 SYLVIO 1970
son epouse
1900 MARIE LAURE 1974

East Face:

1857 PIERRE DESCHENES 1919
son epouse
1863 MATHILDA GAGNON 1927
1887 WILFRED 1926

Marker Stone:

(R19#431) PIERRETTE
DESCHENES
1933 1991

(R19#432) Fortin Monument

West Face:

FORTIN

East Face:

HERMENEGILDE P.
1873 - 1955
ELZIRE N. his wife
1871 - 1925
JOSEPH L. S. FORTIN
1906 - 1998
JAMES E. FORTIN
1930

(R19#428) Caouette Monument

West Face:

Father Son Holyspirit
CAOUETTE
In loving memory

East Face:

1886 LUDGER CAOUETTE 1953
his wife
1891 IDA THIBODEAU CAOUETTE 1930
daughters
1911 JOSEPHINE CAOUETTE 1911
1913 ALICE CAOUETTE 1916
son
1916 ROGER J. CAOUETTE 2002
his wife
1916 CORONA BEAULIEU CAOUETTE 2004
daughter
1948 CARMEN CAOUETTE

Marker Stone:

(R19#429) ROGER J CAOUETTE
Pvt US Army
World War II
Feb 26 1916 Mar 6 2002

Marker: U.S. Veteran

Marker Stones:

(R19#433) HERMENEGILDI P. FORTIN
1873 - 1955

(R19#434) 1899 WILFRED 1899
1909 ODNIA 1911
children of
HERMENEGILD
and
ELXIR FORTIN

(R19#435) Lebourdais Monument

IHS
EDMOND LEBOURDAIS
1877 - 1939
son epouse
HELENE ST. PIERRE
1879 - 1937
LEBOURDAIS

Marker Stones:

(R19#436) MERE

(R19#437) PERE

(R19#438) URSULE 1908 - 1918
ALBERT 1902 - 1919
SIMONNE 1907 - 1920
LEBOURDAIS

(R19#440) Tetreault Monument

West Face:

TETREault

East Face:

EPHREM TETREault
1875 - 1955
ROSE ANNA epouse
1882 - 1962
LEO E. fils
1917 - 1919
IRENE L. fille
1912 - 1997

Marker: U.S. Veteran

(R19#439)

THEODORE E. ADELIA Y.
1903 - 1981 1902 - 1988
LeBOURDAIS

Marker Stones:

(R19#441) OMER L TETREault
Pvt US Army
World War II
Sep 1 1918 Mar 9 1998

(R19#442) LUCIEN F TETREault
PFC US Army
World War II
Feb 25 1911 Aug 22 2000

(R19#445) Gamache Monument

IHS
ERNEST J.
GAMACHE
1898 - 1964
son epouse
LUCIA
LEVESQUE
1899 - 1920
son epouse
CLAUDIA A.
ST. PIERRE
1900 - 1936
GAMACHE

(R19#443)

GEORGE L. TETREault
Maine
Tec 5 US Army
World War II
Oct 1 1905 Mar 20 1963

(R19#444)

LEO P TETREault
Sgt US Army
World War II
Dec 4 1920 Jul 9 1999

Marker Stones:

(R19#446) ERNEST J. Sr.
1898 - 1964

(R19#448) ZELEA
1875 - 1956

(R19#447)

M. LOUISE GAMACHE
1900 - 1999
epouse de
ERNEST J. GAMACHE

Marker Stones Cont'd.

(R19#449) ALPHONSE
1875 - 1927

(R19#450) Mother
MARIE DARAICHE
1865 - 1923

(R19#451) Daughter
ANNA WALLACE
1899 - 1983

(R19#452) Lemieux Monument

LEMIEUX

Marker Stones:

(R19#453) Souvenir
d' ALFRED
fils de
AUGUSTE & ADELE
LEMIEUX
decede 3 Juillet 1883
age 8 mois 15 jours

(R19#454) Souvenir de
VICTORE
fils de
AUGUSTE & ADELE
LEMIEUX
decede 11 Sept. 1884
age 8 sem.....

(R19#455) JUMEAU
ALFRED - THERESE
1927 - 1929

(R19#456) FLORIDA C.
BERNIER LEMIEUX
1890 - 1962

(R19#457) Fils
CHARLES AUGUSTE
1881 - 1946

(R19#458) Pere
CHARLES AUGUSTE
1852 - 1920

(R19#459) Mere
ADELE
1857 - 1931

(R19#460) ERNEST C. PARADIS
1878 - 1923

(R19#461) ADELE PARADIS
1890 - 1924

(R19#462) STEPHEN C. TOTH
1957 - 1999
son of JOHN & CECILE

(R19#463) CECILE A. TOTH
1925 - 2008
wife of
JOHN TOTH

(R19#464) JOHN O. TOTH
1926 - 1966
husband of
CECILE LEMIEUX

(R19#465) PERE

(R19#466) MERE

(R19#467) ONCLE

(R19#468)

ARTHUR LABBE

-
Maine

-
Pvt. 74 Inf.
12 Div.
September 2, 1951

Marker: U.S. Veteran

(R19#469)

PHILIAS LABBE

-
Maine

-
Pvt. 151 Depot Brig.
December 13, 1932

(R19#471)

LUMINA LABBE
1872 - 1939

(R19#470)

ARTHUR J. LABBE
1872 - 1937
epouse de
LUMINA DESROCHER

(R19#472)

MARILYN H. M. LABBE
1939 - 1959

(R19#473) Caron Monument

South Face:

NAPOLEON CARON
1876 - 1928
son epouse
JOSEPHINE GIRARD
1874 - 1928
MARIE LOUISE D.
1901 - 1921
LUCIEN
1912 - 1914
ROLAND A.
1906 - 1939
CARON

North Face:

EVA R. CASTONGUAY
1910 - 1981
.JOSEPH N. CARON
1903 -
wife
GERMAINE B. TONDREAU
1905 -

Marker Stones:

(R19#474)

CARON
JOSEPH N. GERMAINE B.
1903 - 1988 1905 - 1988
In God's care

(R19#475)

EVA R. CASTONGUAY
Jan. 27, 1910 - Oct. 24, 1981
Say a Hail Mary

(R19#476) Cloutier Monument

West Face:

HENRY LAPIERRE
1917 - 2003
his wife
MARIE ANNE
1921

East Face:

EDOUARD CLOUTIER
1871 - 1928
ODILE OUELLET
1866 - 1923
son epouse
EVA MENARD
1891 - 1956
CLOUTIER

Marker: U.S. Veteran

(R19#481) Beauregard Monument

IHS
HENRY L. BEAUREGARD
1871 - 1942
EUGENIE GAMACHE his wife
1872 - 1951
FRANCIS G. BEAUREGARD
1905 - 1928
BEAUREGARD

Marker Stones:

(R19#482) MOTHER

(R19#483) FATHER

(R19#484) FRANCIS

(R19#485) LOUIS H BEAUREGARD

Maine
Pvt 2053 Avn Ord Co
World War II
July 14 1898 Sept 21 1972

Marker Stone:

(R19#477) HENRY G LAPIERRE
Pvt US Army
World War II
Jan 1 1917 Aug 7 2003

(R19#478) Tupper Monument

West Face:

O Mary, conieved
without sin, pray
for us who have
recourse to thee.
TUPPER

East Face:

JAMES H. TUPPER Sr
1893 - 1955
YVONNE his wife
1903 - 1992
JAMES H. TUPPER Jr.
1928 - 1994
LEONORA his wife
1925 - 2002
MARY JANE TUPPER
1858 - 1923

Marker: U.S. Veteran

Marker Stones:

(R19#479) MARY JANE

(R19#480) JAMES H TUPPER
US Army
World War II
Aug 10 1928 Sep 26 1994

(R19#486) Daignault / McDuff Monument

West Face:

DAIGNAULT
PAUL J. ROSE A.
Oct. 6, 1898 Aug. 22, 1896
Oct. 22, 1984 Feb. 7, 1978

East Face:

McDUFF
PIERRE MARIE
1862 - 1933 1863 - 1915

Marker Stone:

(R19#487) DIANA McDUFF
GAUDREAU
1890 - 1937

(R19#488) Desjardins Monument

West Face:

PIERRE DESJARDINS
1872 - 1933
son epouse
ELMIRE VERMETTE
1877 - 1915
DESJARDENS

Marker Stones:

(R19#489) GEOFFREY

(R19#490) LEONIE

(R19#491) YVONNE

(R19#492) CECILE

East Face:

daughters
CECILE T. DESJARDINS
1908 - 1982
YVONNE D. THIBODEAU
1899 - 1990
GEOFFREY DESJARDINS
1895 - 1992
his wife
LEONIE E. DESJARDINS
1897 - 1970

(R19#493) deLorimier Monument

West Face:

deLORIMIER
Our life and love lives on in
all who knew us.

East Face:

RODOLPHE N. deLORIMIER
Nov. 28, 1920 - May 29, 2003
his wife
CAROLINE L. ANCTIL
Dec. 24, 1923 -
Together forever in God's care

Marker Stones:

(R19#494) deLORIMIER
EVA marier RODOLPHE
1890 - 1969 5 Juin 1911 1885 - 1979

(R19#495) RODOLPHE deLORIMIER
Cpl US Army
World War II
Nov 28 1920 May 29 2003

Marker: U.S. Veteran

(R19#496) Ouellette Monument

West Face:

NAPOLEON OUELLETTE
1863 - 1930
son epouse
LEDA PLOURDE
1868 - 1934
OUELLETTE

East Face:

THOMAS OUELLETTE
1836 - 1915
JOSEPHINE RACINE
1842 - 1923
GEORGE OUELLETTE
1865 - 1923
LUCIE M. OUELLETTE
1873 - 1950

Marker Stone:

(R19#497) AURELIE PLOURDE
1871 - 1961

(R19#498) Lebel Monument

West Face:

LEBEL

East Face:

1865	EDMOND	1950
1870	EMILIE	1942
1896	YVONNE	1918
1901	JEANNE	1917
1903	LUCIEN	1919
1904	ANITA	1917
1909	CLAIRE	1917
1912	GRATIENNE	1917

V.M. Co.

(R19#499) Gagnon Monument

West Face:

Ici repose le corps de
ARMENIE COUCHON
epouse de
ALFRED GAGNON
decedee
le 9 Janvier 1919
a l'age de 36 ans
et 9 mois
R. I. P.
GAGNON

South Face:

ALFRED GAGNON
1882 - 1958
his wife
MARIE GAGNON
1884 - 1951

ST. JOHN THE BAPTIST CEMETERY - Range Layout

RANGE #20

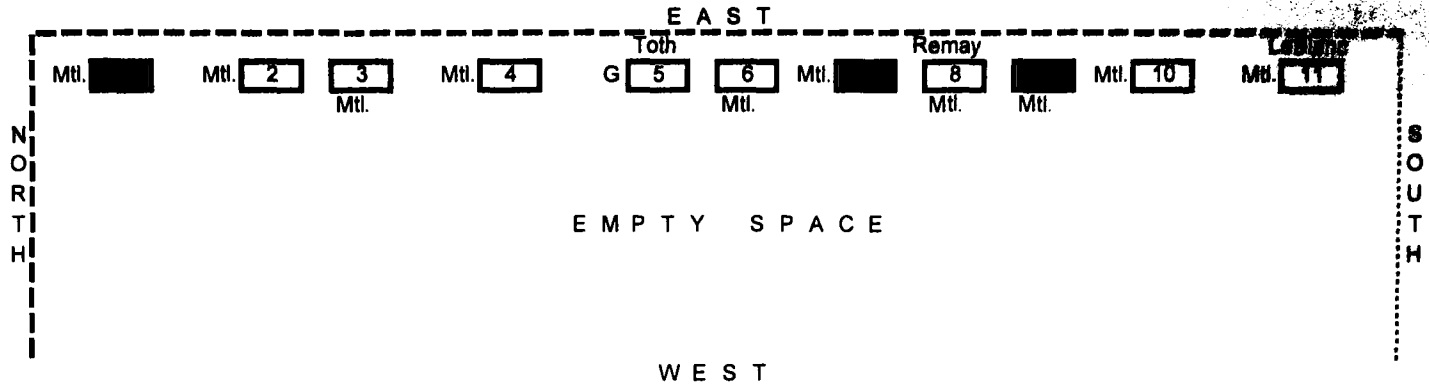

RANGE #20

(R20#1) (Blank Mtl. Undertaker Marker)

(R20#6) (Blank Mtl. Undertaker Marker)

(R20#2) (Mtl. Post)

(R20#7) (Blank Mtl. Undertaker Marker)

(R20#3) (Blank Mtl. Undertaker Marker)

(R20#8) ALFRED RAMEY
1946 - 1946

(R20#4) (Blank Mtl. Undertaker Marker)

(R20#9) (Blank Mtl. Undertaker Marker)

(R20#5) THOMAS TOTH
Oct. 26, 1939
beloved son of
MICHAEL & MARY TOTH

(R20#10) (Blank Mtl. Undertaker Marker)

(R20#11) Baby of ROBERT LEBLANC
July - 1946

ADDITIONAL CEMETERY BURIALS

In a comparison to a previous listing of this cemetery, a number of burials are listed for which no marker stone was located in this recording of the cemetery. Together with names supplied from current cemetery records for unmarked burials the following list was developed.

ALLARD

William Allard, - Aug. 30,, aged 36 yrs. - Range #11

ARSENAULT

Delian A. Arsenault, 1878 - 1969 - Range #4

BARNEAU

Marie Louise Barneau

BEAUDOIN

Joice Beaudoin, May 1940

Orville Bert Beaudoin

BEGAN

Jno. Began, Co. B 7th Inf.

BELANGER

Anastasie Menard Belanger, 1861 - Jan. 1, 1947, aged 85 yrs. - Range #19

BERGERON

Marie Augustin Bergeron, died Oct. 26, 1952, aged 1 day - Range #20

BERNIER

Joseph Robert Bernier, died March 1952 - Range #20

BLEAU

Bleau, child of Arthur, died Jan. 18, 1953, aged 1 day - Range #20

Bleau, child of Arthur, died June 12, 1954, aged 1 day - Range #20

BOIS

Thomas Bois, Maine, Pvt. 101 T M Btry, 26 Div. World War I, Aug. 18, 1896 -
May 5, 1953, aged 56 yrs. - Range #13

Thomas L. (Damase) Bois, Sept. 21, 1943 - Range #19

BOIZARD

Pierre M. Boizard, 1861 - 1943

BOLDUC

William Bolduc, 1890 - Sept. 1, 1963, aged 73 yrs. - Range #1

BOUCHARD

Georgianna Morin Bouchard, 1882 - Oct. 19, 1968 - Range #17

BOUCHER

Auguste Boucher, 1881 - 1939

BOURGOIN

Helen Wilma Bourgoin, died 1939, aged 4 yrs. - Range #19

BOWLEY

Thoron Bowley III, died Jan. 12, 1960, aged 2 1/2 months - Range #20

BOYDEN

Charles M. Boyden, 1959 - April 7, 1960, aged 10 months - Range #1

BRAULIER

Xavier Braulier, died Sept. 7, 1889, aged 55 yrs. 6 mos.

BUERRETTE

Rosa Buerrette, 1903 - 1925

BURNHAM

Barbara Ann Burnham, Dec. 1, 1948 or 1940

CHUTHIER

Jeanne Chuthier, 1908

Leopold Chuthier, 1902

CIMON

Nellie Laviguer Cimon, 1903 - Oct. 12, 1946 - Range #6

CLOUTIER

Eve H. Cloutier, 1920 - 1923, aged 3 yrs. - Range #13

CONNOR

Connor, daughter of Joseph E., died Dec. 2, 1962, aged 1 day - Range #20

COTE

Emelie Cote, 1865 - 1938

Thelespore Cote, 1865 - 1938

DEMERS

Regina Vandal Demers, 1882 - 1965, aged 83 yrs. - Range #13

Wilfred J. Demers, 1883 - Feb. 20, 1939 - Range #13

DESCHENE

Edward J. Deschene, 1886 - 19....

George Deschene, 1883 - 1947

DEVONVILLE

Roland Devonville, 1930 - 1945

DUMAISE

Howard C. Dumaise, 1874 - 1946

FORTIN

Marie Louise Fortin, infant dau. of Fortin, died Apr. 9, 1891, aged 1 mo.

Richard Henry Fortin, 1942 - March 26, 1943, aged 6 mos. - Range #16

FOURNIER

Alphonse L. Fournier, 1862 - Oct. 17, 1943, aged 81 yrs. - Range #7

GAGNE

Marie Gagne, 1879 - 1964

GALLAGHER

Catherine Gallagher, baby, died 1938

GALLANT

M. J. Gallant, died Sept. 22, 1888, aged 21 yrs.

GALUZA

Mark Galuza, 1951 - 1952

GAMACHE

Eugenie Gamache, died July 15, 1873, aged 7 mos. 8 ds. - Range #7

GAUTHIER

George Joseph Gauthier, 1899 - Feb. 27, 1956, aged 56 yrs. - Range #16

GAVEGHIO

Aliandro Gaveghio

GEROW

Gerow, child of Orville, died Nov. 3, 1952, aged 1 day - Range #20

GUINARD

Miriael Guinard, 1910 - Jan. 14, 1988 - Range #9

Napdean Alfred Guinard, 1904 - March 27, 1984, aged 80 yrs. - Range #9

HANES

Racheal Mary Troubea Hanes, 1881 - June 10, 1940 - Range #9

HOOVER

Brenda Doane Hoover, July 3, 1958 - July 16, 1958, 13 days - Range #1

HUARD

Alice Huard, died 1912, aged 8 mos. - Range #12

Amie Huard, died 1914, aged 1 yr. - Range #12

Joseph Huard, died 1924, aged 9 yrs. - Range #12

Josephine Huard, died 1910, aged 13 mos. - Range #12

HUGHES

Timothy Patrick Hughes, April 21, 1964, aged 1 day - Range #1

JOHNSON

Johnson, child of Archie, died Jan. 17, 1953, aged 1 day - Range #20

KALUZA

Mark Kaluza, Dec. 1951 - May 1, 1952, aged 6 mos. - Range #1

KING

King, child of Edwin, died Aug. 31, 1950, aged 1 day - Range #20

LABBE

Helena Labbe, 1909 - Oct. 14, 1909, aged 6 mos. - Range #7

Henriette Varboncoeur Labbe, 1855 - Oct. 13, 1909 - Range #15

Herve Labbe, 1879 - Nov. 24, 1945, aged 66 yrs. - Range #15

Rosario J. Labbe, 1915 - April 4, 1943, aged 27 yrs. - Range #15

LABBEE

Henri Labbee, 1914 - 1921

Mary Arlene Labbee, Apr. 30, 1936 - Dec. 14, 1937

Rodney Ray Labbe, died Sept. 15, 1949 aged 1 day - Range #20

LABERG

George Laberg, 1877 - 1965

Merilda Tremblay Laberge, 1876 - Feb. 3, 1938, aged 61 yrs. - Range #3

LaPOINTE

Scott Wayne Lapointe, died Jan. 3, 1947 - Range #20

Wilfrid A. LaPointe, Maine, Cpl. Co. 72 Art. CAC, WWI, Apr. 10, 1891 - Nov. 24, 1956 -
Range #7

LAVALLEE

Anthime Lavallee, died 1884, aged 21 yrs. - Range #13

Salome Deshetre Lavallee, 1853 - Aug. 28, 1933, aged 80 yrs. - Range #13

LEBLANC

L. Leblanc, died June 17, 1947 - Range #20

R. Leblanc, died July 21, 1947 - Range #20

LEBRECQUE

Lucien V. Lebrecque, 1899 - 1942

LEMARRE

Marie Louise Lemarre, 1883 - May 31, 1968 - Range #16

Marre Lemarre, 1913

Napoleon Lemarre, 1890 - Sept. 30, 1958 - Range #16

LEMIEUX

M. El ...ena Lemieux, infant

LEVESQUE

Jean Raymond Levesque, died March 7, 1947 - Range #1

LEVESONE

Salome St. Pierre, wife of Louis Levesone, 1858 - 193...

LOSIER

Philip Losier, 1881 - 1960

MARTINEAU

Brenton Wilford Martineau, died 1890, aged 15 mos. - Range #12

Louise Martineau - Range #12

MENARD

Exilda Menard, 1866 - Jan. 25, 1962, aged 96 yrs. - Range #19

Lionel Menard, Sept. 1911 - Nov. 1913, aged 2 yrs. - Range #16

MESSIER

Messier, son of Philip, died Dec. 15, 1957, stillborn - Range #20

MILLER

William Leo Miller Jr., died 1947, aged 2 months - Range #19

MONAHAN

Kerry C. Monahan, 1960 - 1960, aged 1 day - Range #1

MORIN

Adrien Morin, sister of Nestor Morin, aged 8 mos. - Range #19

J. Robert Lemont Morin, Dec. 1940 - Dec. 26, 1940, aged 10 dys. - Range #17

O'DONNELL

O'Donnell, son of Michael, died Mar. 19, 1958, stillborn - Range #20

OUELLETTE

Arthur Ouellette, 1876 - Sept. 14, 1942, aged 66 yrs. - Range #16

Nancy Ann Ouellette, 1970 - 1970, aged 6 hrs. - Range #6

Philomene Emile Ouellette, 1903 - July 15, 1912, aged 8 yrs. 8 mos. - Range #16

Yvonne B. Bernier, wife of Joseph Z. Ouellette, 1899 - Feb. 24, 1962, aged 63 yrs. -
Range #19

PAIMENT

Alfred Paiment, died Apr. 29, 1950 - Range #20

PAQUETTE

Eva St. Hilaire Paquette (Gauvin), wife of Napoleon Paquette, 1887 - June 15, 1973.
aged 86 yrs. - Range #19

Janet Ruest Paquette, died 2005, aged 83 yrs. - Range #19

PARADIS

Paradis, daughter of Robert, died Jan. 10, 1957, stillborn - Range #20

PATURE

Hyppolite Cloutier, wife of Philamond Pature, 1860 - Feb. 16, 1916, aged 55 yrs. -
Range #16

PEAULIEU

Emile Conet, wife of Alexis Peaulieu, died Dec. 12, 1896, aged 70 yrs.

PELLETIER

Pelletier, son of Henry, died July 6, 1953, stillborn - Range #20

Pelletier, child of Wilfred, died Feb. 1947, stillborn - Range #20

PELTIER

Lea Peltier

PETERSON

Lauretta Rich Peterson, 1945 - 1945

PINETTE

Joseph Pinette, 1878 - 1937

Pinette, child of Laurent, died March 9, 1953, age 18 weeks - Range #20

FLOURDE

Arthur J. Flourde, 1939 - Nov. 16, 1942, aged 52 yrs. - Range #19

Joseph Eugene Flourde, Apr. 30, 1951 - May 2, 1951 - Range #1

Joseph Flourde, 1875 - Oct. 14, 1947, aged 72 yrs. - Range #13

PLYMPTON

Charlotte Plympton, 1893 - May 14, 1971 - Range #17

RACINE

Josephine Guerette Racine, 1876 - Jan. 12, 1965, aged 88 yrs. - Range #15

Prudent Racine Jr., 1867 - 1944

Racine, child of Raymond, died Nov. 13, 1955, aged 1 day - Range #20

RATELLE

Arthemise Campeau, wife of Alfred Ratelle, 1854 - Mar. 24, 1902, aged 47 yrs. - Range #8

RITCHIE

Harry L. Ritchie, 1888 - March 29, 1960, aged 71 yrs. - Range #13

ROACH

John Patrick Roach, died Oct. 24, 1962, aged 1 day - Range #20

RUEST

John Ruest, 1961 - 1974 - Range #19

Pricilla Margret Ruest - Range #19

Sarah Caouette Ruest, died 1917, aged 24 yrs. - Range #19

ST. CLARE

Albert J. St. Clare, died Dec. 20, 1952 - Range #1

ST. PIERRE

Robert St. Pierre, died Feb. 16, 1949 aged 4 weeks - Range #20

TAYLOR

Michelle A. Taylor, Nov. 10, 1971, stillborn - Range #13

TETU

Raymond Tetu, 1929 - 1930

THIBEAULT

Henri R Thibeault, 1904 -

Joseph Wilfrid Thibeault, Maine, Pvt. S U G Co. 389 Inf., WWII, Oct. 22, 1900 -

Apr. 25, 1962, aged 61 yrs. - Range #19

M Clair Thibeault, 1916 -

Thibeault, son of Roger, died Mar. 20, 1959, stillborn - Range #20

TRUSIANI

Trusiani, son of Arthur, died Sept. 26, 1961, stillborn - Range #20

VERMETTE

Vermette, child of John, died Aug. 23, 1952, aged 1 day - Range #20

WADE

Jacenta Gayle Wade, Aug. 6, 1964, aged 3 hrs. - Range #4

WHITE

Mary White, died Nov. 8, 1965 - Range #20

WINCAID

Theresa A. Wincaid, 1961 - 1961

TRANSLATIONS

A number of the stones in this cemetery are written in French. A rough translation for some of the more common words or phrases found in the cemetery follows:

a - to, at, in, its (mine/yours/..), with
a l'age - at the age of
age - age
agee - old
aimer - to like
ami - friend, supporter
amie - friend, supporter
ange - guardian angel
annee - year
ans - year
a peine - scarcely, hardly
au - to, at, in, its (mine/yours/..), with
autre - other
aux - to, at, in, its (mine/yours/..), with
ave - Hail Mary
ayez - to have
beni - to bless
bien - good
cher, chere - dear
cieux - heaven
ci-git - here lies
coeur - heart
corps - body
d' - from, to, of, some, any
dame - lady
dans - in
de - from, to, of, some, any
decede - deceased
decedee - deceased
defunt - deceased
defunte - deceased
deja - already, before
deuxieme - second
dieu - God
dites - to say, to tell
douce - soft, sweet, mild, pleasant
doux - soft, sweet, mild, pleasant
du - from, to, of, some, any
elle - she
en - in

enfant - child
enfants - children
epouse - spouse
epouses - spouses
epoux - spouse
et - and
etes - being, to be
etre - being, to be
eux - they
fait - made
faite - made
famille - family
feu - the late, fire
fille - daughter
fils - son
fois - time
ici - here
if - if
in - with it
je - I, I'm
jour - day
jours (jrs.) - days, a week
la - there
l'ame - the heart
l'annee - the year
le - the
les - the, them
leur - them, their
leurs - theirs
lui - him, her
mamam - mommy
membre - member
memoire - memory
mere - mother
misericorde - mercy, pardon us
Mme. - Mrs.
moi - me
mois (ms.) - month
mon - my
mort - dead

morte - dead
me - born in
nee - born in
nom - name
notre - our, ours
nous - us or we
oui - yes
pacifique - Pacific
paix - peace
parent - relative, relation
parents - parents
passer - to pass
passer - to pass
peine - sorrow, sadness, sentence
pere - father
peu - little, not much
pitie - pity
pour - for
prier - to pray
priere - to pray
priez - to pray
que - that, whether, may
quel - which
quelle - which
quelles - which
quels - which
qui - who
qu'ils - may they
quitte - quits
regretter - to miss, to regret
repos - rest
reposant - restful
repose - repose

reposee - repose
resurrection - resurrection
sa - his
sacre - sacred
Saint - Saint
Sainte - Saint
salue - salute
saluer - to greet
salut - wave, salute, greeting, salvation
salve - salvo
sanctifie - sanctify
sanctifier - to sanctify
sante - health
seigneur - lord
semaine (sem.) - week
ses - his, her, its
soeur - sister
soit - so be it, in other words
son - his
souvenir - in memory of, to remember
suis - here, to have, to be
ta - your
tante - aunt
tue - killed
un - an, a
veuve - widowed
vie - life
vierge - virgin
volonte - will
vos - your
votre - your
vous - you

MONTHS

Janvier (Janv.) - January

Fevrier (Fev.) - February

Mars - March

Avril (Avr.) - April

Mai - May

Jun - June

Juillet (Juillette) (Juil.) - July

Aout - August

Septembre (Sept.) - September

Octobre (Oct.) - October

Novembre (Nov.) - November

Decembre (Dec.) - December

NUMBERS

Zero - Zero

Un - One

Deux - Two

Trois - Three

Quatre - Four

Cinq - Five

Six - Six

Sept - Seven

Huit - Eight

Neuf - Nine

Dix - Ten

LATIN:

Salve regina - God save the Queen

Requiescant in pace - Rest in Peace

INDEX BY FAMILY NAME

This index is arranged alphabetically by Family Name listing all markers and monuments in the cemetery. The numbers following the name indicate the location on the map and in the text where the name is represented.

Abrams - R10#42
Adami - R9#114
Adelise - R16#226, R16#227
Aglae - R16#98
Albert - R1#463, R1#465, R12#125, R18#90, R18#237, R18#238
Alexander - R1#473, R18#87, R18#497
Aline - R19#213
Allard - R1#443, R1#445, R9#93, R9#94, R9#95, R9#96, R9#204, R11#32, R13#18, R18#8, R18#19, R18#49, R19#189, R19#197, R19#231
Allen - R13#40, R19#267
Almy - R1#413, R1#414
Aloisio - R2#19
Anctil - R1#183, R1#188, R6#51, R16#221, R19#493
Antil - R2#20, R2#31
Argoitte - R8#35
Armstrong - R9#160, R9#161
Arris - R1#618
Arsenault - R1#299, R1#300, R1#301, R1#581, R5#59, R6#76, R7#4, R7#6
Athenaise - R11#100
Atkins - R18#23, R18#24, R18#25, R18#243
Aube - R1#302, R1#304, R19#387
Aucott - R19#391
Auguste - R19#457, R19#458, R19#459
Babineau - R19#67, R19#68
Bachand - R5#31
Bacon - R2#2
Bailey - R1#64
Baillargeon - R2#14, R16#125
Bailly - R1#21
Barnforth - R1#193, R1#195
Baptiste - R9#79
Bard - R19#222
Baribault - R19#147
Baribeau - R1#103, R1#104, R1#105, R1#106, R1#107, R5#48, R5#49, R5#50, R5#51, R1#52, R5#53, R18#207, R19#211
Barnes - R19#351
Barnier - R8#13
Barribeau - R8#18
Barrington - R18#68, R18#69
Bartlett - R18#501
Basinet - R13#102
Baumann - R18#333
Bazinet - R12#125

Beauchene - R5#7, R5#8, R5#9, R9#97, R9#98, R9#99, R9#100, R10#60

Beaudette - R11#104

Beaudoin - R4#1, R4#2, R4#3, R6#63, R7#114, R7#115, R9#82, R9#83, R9#84, R17#177,
R18#10, R18#479

Beaudry - R11#80

Beauleu - R16#183

Beaulieu - R1#458, R1#585, R8#8, R12#35, R16#183, R17#86, R17#87, R17#88, R18#15,
R18#163, R18#397, R18#398, R19#428

Beauregard - R1#579, R12#38, R12#39, R12#40, R19#185, R19#481, R19#482, R19#483,
R19#484, R19#485

Bechard - R19#23

Bedard - R1#158

Beebe - R19#339

Beland - R9#27, R9#29

Belanger - R1#17, R1#18, R1#102, R1#145, R1#165, R1#166, R1#167, R1#168, R1#244, R1#342,
R1#343, R1#352, R1#353, R1#354, R1#355, R1#356, R1#430, R1#492, R1#493, R1#503,
R1#506, R1#507, R1#612, R4#7, R4#8, R4#10, R4#11, R6#46, R6#53, R7#26, R7#78,
R7#79, R9#116, R9#117, R11#1, R12#102, R13#1, R13#2, R13#3, R13#4, R13#5, R13#6,
R15#152, R16#144, R16#177, R17#164, R17#196, R17#200, R17#201, R17#242, R18#39,
R18#184, R18#388, R19#79, R19#80, R19#81, R19#85, R19#86, R19#119, R19#308,
R19#415

Benoit - R12#51, R18#451, R18#452, R18#462, R19#203, R19#204, R19#205, R19#206,
R19#207, R19#210, R19#300

Bergen - R19#116

Berger - R8#25, R12#67, R12#71, R19#288

Bergeron - R1#215, R1#216, R1#258, R1#259, R1#437, R1#438, R4#6, R6#73, R9#93, R9#96,
R17#18, R17#19, R17#20, R17#21, R17#196, R17#197

Bernier - R1#19, R1#20, R1#24, R1#29, R1#30, R1#31, R1#32, R1#52, R1#67, R1#75, R1#90,
R1#181, R1#182, R1#184, R1#218, R1#219, R1#244, R1#277, R1#302, R1#303, R1#304,
R1#305, R1#306, R1#334, R1#367, R1#427, R1#428, R1#429, R1#467, R1#468, R1#469,
R1#470, R1#481, R1#505, R1#522, R1#602, R1#603, R1#605, R2#7, R2#17, R3#6, R3#7,
R3#8, R3#9, R3#10, R3#11, R3#12, R4#36, R4#39, R4#54, R4#57, R4#61, R4#62, R5#44,
R6#37, R7#26, R7#44, R7#50, R7#96, R7#97, R7#98, R9#87, R9#88, R9#89, R9#107,
R9#149, R9#167, R9#171, R9#172, R9#195, R9#224, R9#225, R11#52, R11#69, R11#70,
R11#85, R12#121, R13#51, R13#110, R13#113, R13#115, R15#120, R15#176, R15#177,
R15#178, R16#16, R16#17, R16#18, R16#180, R16#222, R17#64, R17#65, R17#66,
R17#67, R17#68, R17#69, R17#70, R17#144, R17#149, R17#160, R17#196, R17#198,
R17#199, R17#228, R17#229, R17#230, R18#85, R18#93, R18#101, R18#120, R18#152,
R18#288, R18#295, R18#306, R18#307, R18#314, R18#355, R18#357, R18#365,
R18#366, R18#367, R18#372, R18#425, R18#430, R18#447, R18#469, R18#470,
R18#471, R18#472, R18#492, R18#500, R19#31, R19#32, R19#33, R19#43, R19#56,
R19#58, R19#59, R19#120, R19#121, R19#122, R19#123, R19#125, R19#126, R19#127,
R19#130, R19#131, R19#132, R19#149, R19#150, R19#151, R19#152, R19#223,
R19#366, R19#367, R19#368, R19#369, R19#370, R19#418, R19#456

Berry - R19#37

Berube - R1#407, R1#408, R1#409, R1#410, R1#411, R1#412, R17#135, R18#89, R19#108,
R19#318, R19#336, R19#337

Besaw - R12#124

Biette - R5#21, R5#22, R5#23, R6#43, R16#4, R16#5, R16#6, R16#7, R16#8, R16#9, R16#10,
R19#129

Billier - R9#27, R9#28, R9#30

Bilodeau - R1#37, R12#105, R15#99

Bishop - R18#241

Bisson - R1#131, R1#160, R1#285, R1#325, R1#359, R1#360, R1#446, R1#447, R1#491, R1#551,
R1#552, R6#81, R9#101, R9#102, R9#103, R9#129, R9#130, R9#131, R9#216, R9#217,
R9#218, R17#181, R17#239, R17#244, R18#162, R19#393

Blackie - R1#487

Blair - R18#505

Blaisdell - R18#55

Blanchard - R1#540, R1#542, R18#371

Blanchette - R1#74, R1#248, R1#534, R13#97, R18#380, R18#381, R18#382, R19#119

Boardman - R15#153, R15#154, R15#155

Boire - R9#112, R9#113

Bois - R1#139, R7#52, R9#141, R11#131, R11#132, R11#133, R12#18, R13#56, R13#65, R19#17,
R19#234, R19#237

Boisvert - R5#14, R5#15, R5#16

Boivert - R8#7

Bolduc - R1#200, R1#201, R1#202, R1#558, R17#91, R18#399

Bollinger - R18#231, R18#232, R18#278, R18#279

Bombardier - R10#25, R10#29

Bonang - R5#36, R5#37, R5#38

Bonbardier - R9#47

Bonenfant - R9#33

Bonnar - R11#93

Bonner - R7#110

Bonzacni - R18#251

Bosse - R9#35, R9#36, R9#37, R9#38

Bossie - R1#69

Bouchard - R1#34, R1#149, R1#150, R1#247, R1#267, R1#268, R1#358, R1#395, R5#44, R5#45,
R6#3, R6#4, R7#10, R7#11, R7#85, R7#90, R9#163, R9#180, R9#213, R9#214, R12#91,
R12#92, R13#98, R13#99, R15#27, R17#62, R17#63, R17#71, R17#129, R17#139,
R18#110, R18#130, R18#160, R18#161, R18#179, R18#180, R18#287, R18#294,
R18#358, R18#461, R19#28, R19#47, R19#48, R19#49, R19#50, R19#51, R19#52,
R19#53, R19#96, R19#153, R19#154, R19#155, R19#156, R19#157, R19#158, R19#159,
R19#161, R19#338, R19#394, R19#397, R19#416, R19#417, R19#419, R19#420,
R19#421, R19#422

Boucher - R1#248, R1#249, R1#432, R1#521, R5#29, R5#30, R6#35, R6#91, R6#93, R8#34,
R9#151, R15#157, R15#158, R15#159, R15#175, R17#231, R17#232, R17#233, R17#234,
R17#235, R17#236, R18#442, R19#6, R19#19, R19#20, R19#21

Boulangier - R16#176

Boulay - R13#66, R13#67

Boule - R12#11, R13#75, R13#77, R19#245, R19#250

Bouley - R1#529, R1#530, R1#531

Bourassa - R1#508, R1#606, R12#67, R12#74, R12#75

Bourgault - R1#238

Bourgeois - R18#387

Bourgoin - R1#350, R1#351, R10#82, R11#52, R18#22, R18#168, R19#101, R19#102, R19#103,
R19#104, R19#216
Bourque - R1#177, R1#180, R1#251, R1#252, R10#64, R19#14
Bousquet - R9#200, R9#201, R16#64, R17#133, R18#290
Boutin - R19#11
Boutot - R18#37
Bowen - R10#11
Brady - R18#335
Bramsen - R18#271
Brann - R17#45
Brasard - R17#228
Brassard - R1#109, R1#110, R1#111, R1#338, R7#123, R10#15, R15#95, R18#222, R19#31,
R19#33, R19#267, R19#268, R19#269
Brawn - R19#12
Brennan - R18#299
Breton - R7#9, R12#105, R18#394
Brewer - R17#218, R17#219
Brillant - R1#114, R1#115, R1#162, R1#163, R1#433, R1#434, R1#435, R1#443, R1#444, R4#99,
R4#100, R9#81, R11#76, R11#117, R11#118, R12#14, R12#15, R12#16, R12#17, R12#18,
R13#9, R13#14, R13#18, R15#81, R15#82, R15#83, R17#178, R17#179, R18#83, R18#91,
R18#156, R18#373, R19#148, R19#164, R19#170, R19#172, R19#173, R19#234,
R19#235, R19#236, R19#237, R19#238, R19#239, R19#240, R19#242, R19#423,
R19#424, R19#425, R19#426, R19#427
Brilliant - R9#5, R13#16, R13#17
Brochu - R19#347
Broderick - R7#160, R7#162
Brooks - R5#66
Brown - R11#57
Bruneaux - R11#22
Buchard - R6#64
Buckley - R9#11
Buker - R18#364
Bureau - R9#85
Burgess - R1#34, R1#35, R1#36, R1#114, R1#116, R1#175
Burnham - R18#148, R18#507
Burns - R6#75
Busque - R1#287, R1#288, R1#289
Callaghan - R17#195
Callan - R11#27
Campbell - R1#240, R10#20, R18#409
Campeau - R8#27
Campos - R10#70
Cantin - R18#190
Caouette - R1#231, R1#250, R1#380, R1#381, R1#382, R1#479, R4#19, R4#30, R6#48, R7#25,
R9#77, R9#78, R11#23, R11#24, R12#7, R12#9, R12#10, R12#12, R16#24, R19#235,
R19#355, R19#358, R19#428, R19#429
Card - R12#28
Carey - R9#62, R18#212

Carlin - R12#81

Carlos - R7#70, R16#51

Carlson - R1#77, R1#78, R1#533

Caron - R1#48, R1#50, R1#51, R1#84, R1#96, R1#134, R1#183, R1#185, R1#232, R1#282, R2#22, R3#20, R4#36, R4#37, R4#38, R4#39, R4#40, R4#41, R4#43, R4#44, R4#54, R4#55, R4#56, R4#57, R4#59, R4#88, R6#18, R6#19, R6#46, R7#21, R7#27, R7#105, R7#108, R7#141, R7#142, R7#143, R7#144, R7#145, R7#146, R7#147, R9#32, R9#74, R9#194, R9#205, R10#34, R11#106, R11#113, R11#115, R12#21, R12#22, R12#23, R12#24, R12#25, R12#26, R12#27, R12#28, R12#37, R12#42, R12#77, R12#78, R12#79, R13#32, R13#33, R13#135, R13#136, R13#137, R13#138, R13#139, R13#140, R13#141, R13#170, R13#171, R15#8, R15#9, R15#10, R15#48, R15#112, R15#175, R16#42, R16#81, R16#99, R17#78, R17#79, R17#80, R17#81, R17#82, R17#83, R17#85, R17#203, R17#204, R17#205, R17#206, R17#207, R17#208, R18#165, R18#302, R18#303, R18#451, R19#40, R19#87, R19#129, R19#212, R19#214, R19#215, R19#305, R19#398, R19#399, R19#400, R19#401, R19#473, R19#474

Carrier - R16#64, R16#65

Carter - R1#582, R10#49, R17#173

Carteron - R14#6

Casavant - R16#24

Casey - R11#15, R11#16, R11#17, R11#19, R11#20, R11#21, R18#54, R18#246, R18#247

Casista - R9#16

Castonguay - R9#35, R9#37, R16#223, R19#78, R19#142, R19#143, R19#473, R19#475

Cates - R7#22

Cavecchio - R8#2

Celano - R1#240

Chamberland - R9#189, R9#190

Charon - R15#33

Charron - R1#59, R1#62, R1#145, R1#146, R1#566, R15#5, R15#6, R18#253, R18#265, R18#392, R18#393, R19#69, R19#74, R19#294

Chartier - R12#107

Chase - R19#355, R19#357

Chasse - R18#414, R18#415, R18#416

Chenard - R19#326

Cheverie - R10#68

Chio - R18#267

Chouinard - R19#427

Chrissman - R3#38, R3#39, R10#79

Christman - R5#39, R5#41, R5#42, R5#43, R7#94

Claire - R12#125

Cleary - R19#1

Closson - R18#32

Clouthier - R16#174

Cloutier - R1#119, R1#120, R1#129, R1#130, R1#157, R1#216, R1#233, R1#234, R1#235, R1#236, R1#237, R1#352, R1#354, R5#2, R6#73, R7#116, R7#117, R7#118, R7#119, R9#57, R9#66, R9#67, R9#68, R9#69, R9#159, R9#207, R9#208, R9#209, R10#1, R10#76, R12#11, R12#114, R12#117, R13#150, R13#169, R15#50, R15#57, R16#162, R16#165, R16#166, R16#167, R16#168, R16#204, R17#24, R17#50, R17#52, R17#103, R17#143, R18#296, R18#297, R18#428, R18#505, R19#17, R19#18, R19#212, R19#215, R19#245.

(Cloutier Cont'd.)

R19#246, R19#247, R19#248, R19#249, R19#250, R19#476

Coffin - R15#113, R18#281

Colin - R14#14

Collins - R1#221, R10#23

Colwell - R18#177, R18#189

Comeau - R16#90, R16#92

Comtois - R1#45, R1#47

Connor - R1#246

Cooper - R18#477

Cormier - R1#71, R1#72, R2#9

Costain - R18#166, R18#167

Cote - R1#425, R1#582, R5#62, R6#84, R8#25, R9#16, R10#73, R11#33, R11#34, R11#35,
R16#70, R16#154, R17#36, R17#96, R17#104, R17#105, R17#106, R17#134, R17#143,
R18#453, R19#60, R19#163, R19#275, R19#406, R19#407

Couchon - R19#499

Couet - R8#8

Coughlin - R1#283, R1#284, R1#298

Couillard - R11#94, R11#95, R11#96, R11#97, R11#98, R11#99, R11#100, R15#141, R15#149,
R15#160, R15#164, R17#170, R17#171, R19#332, R19#333, R19#334, R19#335

Coulombe - R1#34, R1#35, R1#394, R1#498, R1#499, R1#500, R1#501, R1#502, R1#509,
R1#553, R1#554, R1#555, R1#561, R1#617, R1#618, R2#22, R4#7, R4#10, R5#50, R6#61,
R6#62, R7#29, R7#133, R7#134, R7#135, R7#136, R7#137, R7#138, R7#139, R9#72,
R9#220, R10#47, R10#51, R13#45, R13#145, R13#146, R13#147, R13#148, R14#4,
R16#138, R18#19, R18#118, R18#122, R18#123, R18#139, R18#172, R18#226, R19#77,
R19#105, R19#383, R19#420

Courtemanche - R1#384, R1#385, R1#386, R1#387, R1#388

Couture - R9#85, R18#109

Couturier - R13#72

Cox - R4#45

Cressey - R16#67

Crimmins - R18#149, R18#455, R18#456, R18#498

Crockett - R1#377, R1#378, R1#379

Croteau - R1#399, R18#129

Cunningham - R10#59

Curry - R15#124, R15#125, R15#126

Cyr - R19#89

Dagenais - R1#95, R1#616, R19#383

Daigle - R9#194, R11#22

Daignault - R19#486

Dall - R3#23, R10#18, R17#173, R17#175, R18#502, R19#27

Dallaire - R9#52, R9#53

Dalton - R6#32, R6#33, R6#34

D'amours - R13#36

Daniel - R6#35, R19#218

Daraiche - R19#450

Dauphin - R18#429

D'auteuil - R1#431, R15#127, R15#128

Davis - R18#268, R18#317, R18#318

Day - R9#62

Debien - R9#75

Dechene - R1#559, R7#13, R8#24, R15#48

DeClemente - R9#58

Decoste - R11#26, R11#28, R11#29, R11#30

Decoster - R17#192, R17#193, R17#194

Deforge - R1#437

Dehetre - R2#15, R3#49, R3#50, R11#84, R11#122, R16#160, R16#161, R16#188, R18#300,
R18#301, R18#302

Deitchman - R10#26

Delagasse - R12#52

Delaney - R4#88, R14#8

Delisle - R5#35

deLorimier - R19#493, R19#494, R19#495

Demers - R11#75, R11#77, R11#78, R11#79, R11#82, R15#74, R16#211, R19#373, R19#375

Denis - R8#3

Denonville - R19#26

Deorsey - R1#261, R1#271, R1#272

Deroche - R7#30, R7#31, R7#32

Derocher - R3#35, R3#36, R3#37, R5#40, R6#81, R13#35, R13#84, R17#36, R17#37, R19#20,
R19#149, R19#150, R19#392

Derosier - R1#439

Desbien - R16#154, R16#159

Desbiens - R1#431, R1#535, R9#76, R16#69, R16#176, R18#448, R18#495

Deschene - R1#614, R15#47, R15#130

Deschenes - R1#48, R1#49, R1#325, R9#141, R9#142, R15#41, R15#49, R16#126, R19#430,
R19#431

Deschine - R15#129

Desjardin - R7#21

Desjardins - R1#339, R1#401, R1#566, R3#42, R3#46, R6#88, R6#89, R7#15, R7#26, R7#103,
R7#104, R7#125, R9#22, R12#4, R13#26, R13#28, R16#4, R16#8, R16#169, R16#170,
R16#171, R16#172, R17#108, R17#109, R17#110, R17#111, R17#112, R17#113,
R18#203, R18#204, R18#333, R18#441, R19#121, R19#488, R19#489, R19#490,
R19#491, R19#492

Deslaurier - R11#33, R19#22

Deslauriers - R16#154, R16#158, R16#159

Desmarais - R7#74, R15#120, R16#129, R16#130, R16#131

Despres - R15#141, R15#149, R16#80

Desrocher - R13#128, R13#129, R19#470

Desrosier - R1#199

Desrosiers - R15#120, R15#122, R19#36

Detonnancourt - R1#224

Devin - R1#474, R13#169

Devonville - R15#70

Diclemente - R9#8

Di Clementi - R17#14, R17#17

Diemer - R1#153

Billman - R15#110

Dion - R9#73, R13#149, R16#66, R16#67, R16#68, R16#69, R16#223

Dionne - R1#39, R1#383, R1#441, R1#448, R1#449, R1#450, R4#13, R4#15, R9#104, R9#105, R9#107, R9#129, R9#130, R9#133, R11#101, R13#51, R15#131, R16#24, R16#157, R16#211, R16#212, R16#213, R17#64, R17#66, R18#345, R19#22, R19#340, R19#341, R19#342, R19#384, R19#385, R19#386

Distefano - R1#621

Doiron - R18#9

Dolan - R7#160, R7#161, R7#162, R7#163, R7#164, R7#165, R10#69, R12#59, R12#60, R12#61, R12#62, R12#63, R12#64, R12#65

Donaldson - R18#58

Donnelly - R3#27, R3#28, R7#23

Donovan - R18#62, R18#467

Doolan - R13#58

Doucette - R6#47, R9#76

Dougher - R7#152, R7#156

Dougherty - R7#2, R7#3, R11#14

Doustou - R1#33, R12#10

Dow - R10#67

Doyon - R1#68, R1#494, R4#42, R8#37, R17#228, R19#222

Drapeau - R1#474, R1#590, R3#51, R3#52, R9#145, R9#146, R11#102, R13#72, R13#73, R13#74, R15#103, R16#70, R17#25, R17#26, R17#60, R17#108, R17#112, R18#104, R18#250, R18#252

Driscoll - R18#141, R18#142

Drolet - R9#186, R9#187

Dubay - R1#593

Dube - R1#70, R1#189, R1#217, R1#312, R1#511, R1#517, R5#44, R6#83, R7#129, R11#49, R11#68, R11#71, R16#49, R18#304, R19#22, R19#120, R19#122, R19#123, R19#327, R19#330, R19#348, R19#349, R19#350, R19#351, R19#352, R19#353, R19#354

Dubois - R1#187, R1#329, R1#330, R1#331, R1#332, R1#333

Dubreuil - R15#56, R15#132, R15#155, R17#125, R17#126, R17#127, R19#321, R19#324, R19#325, R19#326

Duchaine - R7#111

Ducharme - R12#38, R12#39, R13#32, R17#47, R18#13, R18#98, R18#108

Duffy - R16#230, R16#231

Dufour - R7#111

Dufresne - R1#7, R1#543, R6#50, R12#44, R12#45, R12#46, R12#47, R12#48, R15#111, R17#231, R17#233

Dugal - R1#80, R1#81, R1#479, R1#480, R6#85, R6#86

Dugan - R18#111

Duguay - R4#72, R4#73

Dumais - R1#584, R2#13, R5#35, R8#20, R16#179, R18#187, R18#188, R18#427, R19#25, R19#251, R19#252, R19#253, R19#254

Dumont - R9#156, R11#18, R17#130, R18#408, R19#69, R19#72

Duncan - R1#92

Duperre - R18#147

Dupuis - R12#92

Duquesnoy - R9#132, R11#70, R18#383

Duquette - R1#13
Dumond - R9#40, R9#43, R9#44, R10#30
Durgin - R6#31, R7#2, R11#25
Durocher - R8#6
Dustin - R12#128
Duval - R1#30, R1#32, R1#323, R3#42, R3#44, R3#45, R3#46, R3#47, R3#48, R3#49, R3#50,
R3#51, R3#52, R6#44, R18#343, R18#344
Dyer - R9#153, R9#168, R9#169
Earl - R1#216, R1#279, R1#280, R2#26, R2#27, R2#28, R5#20, R9#184, R17#49
Eckert - R9#154
Edwin - R14#10, R14#12
Elie - R17#178, R17#179, R17#180
Elms - R18#99
Eiwell - R1#340, R1#341, R4#25
Emmons - R1#580
Emond - R1#155, R1#392, R15#93, R19#313
Engerski - R16#155, R16#156
Estes - R19#51
Fahy - R7#152, R7#153
Fakler - R11#81, R11#83
Favreau - R1#136, R1#137, R1#193, R1#194, R1#195, R1#196, R1#203, R1#204, R1#205,
R1#605, R7#148, R9#174, R9#175, R12#96, R13#133, R17#174, R18#215, R18#216,
R18#217, R19#299, R19#300, R19#301, R19#302, R19#304
Feehan - R18#504
Fenimore - R18#223
Fernandes - R18#53
Fickett - R1#240
Field - R5#68, R5#69
Fieser - R10#27
Finlayson - R18#466
Fiori - R9#12, R9#114
Fitz - R1#233, R1#235, R1#236
Flanagan - R17#216, R17#217
Fluet - R9#202, R15#12
Folger - R18#196, R18#206
Footer - R1#293, R1#294, R1#295, R1#296, R1#297, R9#136, R9#137, R9#138, R9#140
Forest - R12#121
Fortier - R1#481, R9#133
Fortin - R1#29, R1#124, R1#148, R1#175, R1#227, R1#228, R1#255, R1#266, R1#324, R1#577,
R1#578, R3#1, R3#2, R3#3, R3#4, R3#5, R4#31, R4#32, R4#33, R4#34, R4#35, R4#37,
R4#43, R5#61, R5#70, R5#71, R5#72, R5#73, R5#74, R6#12, R7#21, R7#114, R11#51,
R12#1, R12#2, R12#3, R12#67, R12#68, R12#69, R12#70, R12#71, R12#72, R12#76,
R12#98, R12#121, R13#89, R13#130, R15#29, R15#30, R15#31, R15#32, R15#33,
R15#51, R15#52, R15#53, R15#54, R15#57, R15#58, R15#59, R15#141, R15#143,
R16#52, R16#53, R16#54, R16#100, R16#101, R16#102, R16#103, R16#104, R16#105,
R16#107, R16#108, R16#192, R16#193, R16#194, R17#39, R17#143, R17#160, R18#40,
R18#46, R18#316, R18#448, R19#69, R19#70, R19#71, R19#72, R19#73, R19#75,
R19#87, R19#88, R19#212, R19#316, R19#347, R19#392, R19#432, R19#433, R19#434

Fougere - R1#109, R1#110, R1#426

Fournier - R1#68, R1#80, R1#227, R1#340, R4#22, R4#23, R4#24, R4#28, R7#39, R7#41, R7#42, R7#43, R7#91, R7#92, R7#93, R9#170, R9#185, R11#64, R11#65, R11#66, R11#67, R11#72, R11#73, R11#74, R12#80, R13#134, R15#53, R16#74, R16#188, R16#235, R16#236, R17#245, R17#247, R18#240, R18#243, R18#244, R19#9, R19#29, R19#30, R19#58, R19#191, R19#193, R19#256, R19#390

Fowler - R1#537, R1#538, R1#539

Fradet - R1#3, R1#4

Fraser - R1#275, R18#334

Frazier - R13#47

Fregeau - R17#61, R19#96

Frenier - R1#589, R19#2

Fricks - R10#45

Frost - R1#587, R1#588

Fucini - R10#43

Gagne - R1#156, R1#253, R2#4, R2#33, R2#34, R5#3, R5#4, R5#5, R7#4, R7#5, R7#6, R13#160, R13#161, R13#162, R15#166, R15#167, R15#168, R15#169, R15#170, R16#141, R16#142, R16#143, R18#175, R19#321, R19#322, R19#323

Gagnon - R1#257, R6#72, R6#90, R7#126, R11#3, R11#4, R11#5, R11#6, R11#7, R11#8, R11#9, R15#11, R15#100, R16#66, R17#60, R17#170, R17#171, R17#172, R18#191, R19#219, R19#412, R19#430, R19#499

Galameau - R1#63, R1#64, R1#65, R1#66

Gallant - R4#17, R4#18, R17#153, R17#237, R19#174

Gamache - R1#20, R1#40, R1#62, R1#96, R1#254, R1#298, R1#310, R1#311, R1#536, R1#596, R1#597, R1#599, R1#600, R5#6, R7#8, R7#33, R7#66, R7#80, R7#81, R7#141, R7#146, R11#113, R11#114, R11#115, R11#116, R12#4, R12#10, R12#11, R12#14, R12#44, R12#122, R12#123, R13#2, R13#91, R13#92, R13#93, R13#94, R13#95, R13#100, R16#19, R16#20, R16#24, R16#25, R16#56, R16#80, R16#81, R16#131, R16#132, R16#186, R16#192, R16#214, R16#216, R16#217, R16#219, R17#61, R17#63, R17#89, R17#90, R17#91, R17#92, R17#93, R17#94, R17#95, R17#158, R17#159, R18#443, R18#444, R18#445, R19#100, R19#256, R19#257, R19#316, R19#445, R19#446, R19#447, R19#448, R19#449, R19#481, R19#482

Gamaish - R12#38

Garand - R1#557, R9#82

Garon - R19#295, R19#298

Garvin - R19#176

Gaudette - R1#399

Gaudreau - R1#82, R1#85, R1#160, R1#350, R1#351, R4#4, R4#6, R6#87, R7#79, R9#76, R13#43, R13#44, R13#45, R13#66, R13#67, R13#68, R15#29, R18#412, R18#496, R19#321, R19#390, R19#487

Gauthier - R16#50, R16#97, R16#98, R16#99, R18#482, R19#90, R19#94

Gauvin - R19#61

Gauvreau - R10#13

Gavin - R1#240, R1#242

Gerow - R1#227, R19#16

Gervais - R1#400

Giard - R18#253, R18#254, R18#264

Giddince - R18#494

Grant - R1#254
Grant - R9#55
Grant - R15#38
Grant - R7#125
Grant - R9#109
Grant - R16#110
Grant - R10#55
Grant - R1#420, R1#421, R1#422, R1#558, R5#24, R5#25, R5#26, R5#27, R5#28, R10#53, R19#392, R19#473
Girardin - R10#24, R17#254, R17#255
Giroux - R1#317, R1#318, R1#375, R2#5, R6#79, R9#221
Gleason - R16#127, R16#128
Glidden - R1#622
Godbout - R9#31, R17#25, R17#27, R17#28, R17#29, R17#30, R18#508, R19#336
Godin - R15#157
Golden - R1#25, R1#97
Goodenow - R18#97
Gosselin - R9#211, R9#212, R15#84, R15#85
Gregoire - R6#51, R6#63, R9#170
Grenier - R12#114, R12#118
Grindle - R1#392
Grondin - R1#82
Groves - R18#208
Gubbins - R18#502
Guerette - R1#132, R1#620, R2#18, R5#31, R13#88
Guertin - R7#150
Guilmette - R19#316, R19#317
Guimond - R3#17, R19#366, R19#367, R19#378, R19#381
Guinard - R1#575
Guptill - R1#495
Hachey - R1#93, R7#82
Hagan - R10#40, R10#41
Hage - R18#350
Haggerty - R17#99
Hall - R13#98, R16#228
Halpin - R9#1
Handley - R19#141
Haney - R7#30
Hanson - R10#81
Harding - R18#128
Harel - R8#7, R16#188
Hart - R15#156
Harton - R15#137, R15#139
Harvey - R13#91, R13#93, R15#66, R15#111, R16#109, R18#7, R19#42
Haskell - R7#24
Hayes - R17#32, R17#33
Hederman - R1#516
Held - R18#242

Bea - R1#203, R1#207, R1#606, R9#101, R9#103, R9#111, R12#88, R18#73, R18#340,
R19#327, R19#328, R19#329, R19#330, R19#331
Blanchard - R13#103, R13#104, R13#105, R13#106, R16#27, R16#28, R16#29, R16#30, R16#31,
R16#32, R16#33
Burby - R18#87, R18#96
Burck - R1#176
Biggins - R3#24, R3#25, R17#124
Hill - R1#496, R1#497
Hodgkins - R5#17, R5#18
Honore - R18#106
Houde - R1#94
Houle - R9#111, R18#225
Howard - R15#42, R15#43, R15#44, R15#45
Howe - R9#13
Huard - R1#231, R7#78, R9#25, R9#182, R9#183, R10#48, R17#90, R18#320, R19#3
Hudak - R1#217
Hudon - R4#68, R4#69, R4#70, R4#71, R6#31
Hudson - R9#51
Hughes - R1#436, R1#601, R9#15, R18#417, R18#418
Hunt - R4#64, R4#66, R4#76, R4#79
Hunter - R17#174
Hunton - R1#240, R1#241, R1#242
Huppe - R1#556, R18#486
Jacques - R1#520, R8#22, R9#127, R12#113, R18#102, R18#117, R18#185
Jalbert - R1#327, R1#339, R8#34
Jameson - R1#292
Jamison - R1#102
Jaques - R10#36
Jean - R4#50, R4#52, R9#115, R9#116, R9#118, R9#119, R18#10, R19#233
Johansen - R17#97, R17#98
Johnsen - R1#475, R1#476, R1#477, R1#478
Johnson - R9#222, R9#223, R17#32, R17#33, R17#34, R19#388, R19#389
Johnston - R17#231, R17#235
Jones - R18#319
Jordan - R18#194
Joslin - R17#31
Journeault - R1#11
Julien - R11#63
Jumeau - R19#455
Kachmar - R2#32, R2#35
Kane - R18#396
Karkos - R18#31
Kearns - R12#125
Keenan - R1#247, R6#80
Kelley - R7#1
Kendrick - R10#16, R10#17, R10#21, R10#22
Kenny - R18#347
Keough - R19#176, R19#186

Kerrigan - R9#139

Kidder - R1#619

Kincaid - R4#87, R4#90, R4#91

Kirouac - R7#54, R7#58, R13#43

Kirouack - R15#175

Kling - R18#87, R18#94, R18#95

Knight - R6#64, R10#37, R18#153

Knold - R1#321, R1#322

Kopatz - R1#471, R1#472

Kral - R18#63

Labbe - R1#44, R1#77, R1#79, R1#147, R1#189, R1#334, R1#335, R1#336, R1#337, R1#369,
R1#370, R1#371, R1#372, R1#373, R1#415, R5#2, R6#25, R7#83, R7#96, R7#97, R9#19,
R9#20, R9#40, R9#41, R9#44, R9#158, R9#226, R10#38, R10#71, R11#53, R11#107,
R11#108, R11#134, R13#103, R13#107, R15#133, R15#134, R15#135, R15#136, R16#45,
R16#46, R16#47, R16#135, R16#136, R16#137, R16#139, R16#140, R16#221, R17#48,
R17#50, R17#52, R17#53, R17#134, R17#155, R17#156, R18#30, R18#34, R18#35,
R18#70, R18#127, R18#362, R18#363, R18#364, R18#484, R18#485, R18#490, R18#491,
R19#13, R19#44, R19#177, R19#179, R19#182, R19#190, R19#199, R19#211, R19#275,
R19#276, R19#280, R19#286, R19#289, R19#290, R19#291, R19#292, R19#293,
R19#294, R19#306, R19#355, R19#356, R19#357, R19#358, R19#359, R19#360,
R19#468, R19#469, R19#470, R19#471, R19#472

Labbee - R11#109, R15#102, R16#44

Labee - R16#42

Labelle - R19#112

Laberge - R1#269, R3#40, R7#89, R16#134, R18#493, R19#240, R19#241, R19#243, R19#244,
R19#343

Labonte - R1#89, R1#122, R1#286, R9#206, R13#151, R13#152, R18#352

Labrecque - R18#476, R18#478, R18#480, R18#487, R19#366, R19#370, R19#371

Lacasse - R2#9, R5#47, R6#20, R6#22, R9#219, R18#84, R18#92, R19#19

Lachance - R1#126, R1#127, R1#197, R1#211, R1#212, R1#213, R1#214, R1#221, R1#222,
R1#223, R1#326, R1#328, R1#357, R1#425, R1#518, R2#23, R2#24, R2#25, R3#44,
R3#45, R5#24, R5#28, R6#44, R9#45, R12#19, R12#20, R12#129, R15#150, R15#151,
R16#152, R16#175, R16#178, R16#182, R16#183, R17#225, R18#56, R18#64, R18#174,
R18#258, R18#259, R19#5, R19#6, R19#7, R19#219, R19#343

Lachapelle - R9#47, R19#41

Lacharite - R6#29, R9#188, R12#5, R12#6, R18#45, R18#164, R18#176

Lacourse - R18#107

Lafebvre - R18#157

Laferriere - R1#463, R1#464, R1#465, R18#136, R18#137

Laffely - R17#212, R17#214, R17#215, R18#37, R18#315, R19#187, R19#188, R19#197,
R19#280, R19#281, R19#282, R19#283, R19#284, R19#285, R19#286, R19#287

Laganiere - R18#437, R18#438

Lagasse - R1#458, R1#459, R1#460

Lamard - R12#123

Lamarque - R1#364, R1#365, R1#366, R15#74, R18#354, R19#90, R19#91, R19#92, R19#93,
R19#94, R19#251, R19#255

Lamarre - R1#161, R1#350, R1#359, R1#482, R1#528, R1#567, R7#99, R7#100, R7#101, R7#102,
R9#196, R9#197, R13#59, R13#60, R13#61, R13#62, R13#63, R16#48, R16#70, R16#71.

(Lamarre Cont'd.)

R16#89, R16#121, R16#123, R16#173, R17#141, R17#142, R18#43, R18#353, R18#368,
R19#267

Lambert - R14#16, R15#71, R15#72

Lamothe - R19#8

Landry - R1#510, R1#547, R13#7, R13#8, R18#41

Lang - R6#17

Langelier - R16#191

Langevin - R6#9, R6#10, R6#11, R19#270, R19#274

Langlais - R18#11, R18#12, R18#14, R19#219

Langley - R16#34, R16#35, R16#36, R16#37, R16#38, R16#39, R16#40, R17#243

Langlois - R13#142

Lanteigne - R18#224

Lapierre - R6#24, R6#26, R6#27, R17#84, R17#114, R19#77, R19#476, R19#477

Lapointe - R1#540, R1#541, R1#542, R6#58, R6#60, R7#15, R7#74, R7#75, R7#76, R7#77,
R13#72, R17#1, R17#3

Laprise - R5#10, R5#11, R5#12, R5#13

Larberge - R19#344

Larcher - R15#3

Larrabee - R18#277

Lassonde - R10#57

Laure - R1#456, R17#247, R19#430

Lavallee - R1#217, R1#261, R11#58, R11#59, R11#61, R11#62, R11#67, R12#8, R15#94,
R16#225, R16#226, R16#227, R16#229, R16#230, R16#231, R17#132, R18#197

Lavigne - R1#1, R1#2, R1#465, R4#20, R4#21, R7#116, R7#117, R7#120, R16#197, R16#198,
R16#199, R16#200, R18#341, R19#313

Lavigueur - R1#348, R4#85, R4#86, R15#114, R15#115, R15#117, R15#119, R19#349

Lavoie - R1#10, R1#169, R1#172, R1#190, R1#615, R5#10, R5#11, R6#77, R7#53, R7#105,
R7#107, R7#108, R8#23, R9#79, R9#192, R9#193, R12#109, R12#110, R13#121,
R13#122, R13#123, R13#124, R13#125, R13#127, R15#127, R16#220, R16#223,
R17#184, R17#187, R17#246, R18#3, R18#173, R18#356, R18#499, R19#219, R19#277,
R19#278, R19#279, R19#319, R19#320, R19#372

Lawrence - R18#100

Leavitt - R9#110, R18#285

Lebel - R1#14, R1#40, R1#56, R1#57, R1#63, R1#73, R1#85, R1#135, R1#197, R1#198, R1#270,
R1#271, R1#451, R1#452, R1#548, R1#556, R6#48, R7#106, R7#148, R7#149, R8#1,
R9#134, R9#164, R11#10, R11#11, R11#12, R11#13, R11#36, R11#101, R11#119,
R11#120, R11#135, R12#51, R13#19, R13#22, R13#73, R13#142, R13#143, R13#144,
R14#9, R15#75, R15#76, R15#77, R15#79, R16#21, R16#22, R16#23, R16#41, R16#43,
R18#219, R18#220, R18#221, R18#248, R19#108, R19#109, R19#110, R19#111,
R19#288, R19#303, R19#347, R19#372, R19#498

Lebell - R9#150

Leblanc - R1#114, R1#115, R1#116, R1#579, R7#13, R7#14, R7#34, R7#35, R7#36, R7#37,
R7#38, R7#106, R10#14, R15#3, R15#4, R19#129, R20#11

Lebourdais - R1#26, R1#28, R1#232, R12#121, R15#27, R15#28, R18#119, R18#292, R18#293,
R19#148, R19#435, R19#436, R19#437, R19#438, R19#439

Leclair - R1#122, R1#123, R17#165, R17#166, R19#165, R19#166, R19#167, R19#168, R19#169,
R19#177, R19#178

Lechaire - R12#107

Leclerc - R1#70, R1#139, R1#140, R1#177, R1#178, R1#179, R1#180, R1#467, R1#469, R1#585,
R6#36, R7#140, R9#70, R9#71, R9#152, R12#82, R12#85, R12#86, R12#87, R16#181,
R17#207, R17#208, R17#209, R17#210, R17#211, R19#372, R19#398

Leda - R16#21, R16#23

Legendre - R7#112, R7#113

Leighton - R4#45

Lemane - R1#471

Lemay - R16#75

Lemes - R1#361

Lemieux - R1#593, R1#594, R8#35, R12#43, R12#82, R12#83, R12#84, R17#144, R17#146,
R17#147, R17#148, R17#149, R17#150, R19#275, R19#378, R19#379, R19#380,
R19#381, R19#382, R19#452, R19#453, R19#454, R19#456, R19#464

Lemire - R8#21, R15#4

Lemlin - R1#329, R1#330

Lent - R5#32, R5#33, R5#34

Lenton - R9#108

Leonard - R4#76, R4#77, R4#78, R4#79, R4#80, R4#81, R7#61, R7#62, R7#63, R7#64, R7#65,
R11#44, R11#45

Lepage - R19#327, R19#329

Letarte - R1#181, R1#183, R1#184, R1#185, R1#186, R1#187, R1#188, R5#63, R5#64, R5#65,
R7#67, R7#68, R7#69, R12#44, R16#119, R19#24, R19#119, R19#412, R19#413,
R19#414, R19#415

Letourneau - R1#505, R18#76, R18#109

Levasseur - R15#69, R17#131, R18#67, R18#70

Leveque - R7#43, R8#10, R11#55, R11#110, R11#111, R11#112

Leverone - R18#200, R18#209

Levesque - R1#5, R1#37, R1#117, R1#118, R1#398, R1#453, R1#454, R1#455, R1#474, R1#486,
R1#503, R1#512, R3#6, R3#12, R5#6, R6#50, R6#55, R6#56, R7#9, R7#42, R9#25,
R9#26, R9#77, R9#81, R10#10, R11#2, R11#103, R11#105, R14#3, R15#23, R15#24,
R15#25, R15#74, R15#99, R15#101, R16#17, R16#60, R16#61, R16#63, R16#87,
R16#237, R16#238, R16#239, R17#212, R17#215, R18#245, R18#378, R18#379,
R18#389, R18#390, R18#436, R18#442, R19#153, R19#156, R19#270, R19#273,
R19#307, R19#445

Lewis - R18#74, R18#265, R18#266

Lex - R18#334

Libby - R15#156

Litchfield - R18#446

Little - R6#43

Livernois - R1#533, R6#14, R6#15, R15#103, R15#104, R15#105, R16#189, R17#139, R17#144,
R17#145, R17#147, R17#202, R18#338, R19#373, R19#374, R19#375, R19#377

Lizotte - R19#76

Loewe - R1#509

Longtin - R13#9, R13#10, R13#11, R13#12, R13#13, R13#14, R13#15, R13#43

Lord - R1#375, R1#376, R1#430, R6#41, R6#42, R9#173, R18#255, R18#256

Lovett - R19#232

Lowe - R1#352, R1#356

Lowell - R19#363, R19#364, R19#365

Lucas - R18#400
Luce - R1#240
Lyon - R18#16
MacDonald - R1#537, R1#538, R9#34
MacHatton - R15#118
MacKenzie - R1#623
Mackovjak - R9#149
MacMahon - R18#475
Madden - R7#152, R7#154, R7#155, R11#25
Magee - R1#256, R2#1, R9#222, R19#39
Maicangelo - R8#4
Mailloux - R13#131, R13#132
Mailly - R1#225, R1#226
Majernik - R8#16
Marais - R16#51
Marcin - R6#90
Marcou - R12#38
Marcous - R12#38
Marin - R6#61
Marino - R18#78, R18#79
Marois - R5#20, R9#203, R19#288
**Marquis - R1#53, R1#54, R1#55, R1#392, R1#393, R1#550, R2#10, R8#5, R8#11, R13#69,
R13#70, R13#71, R13#88, R13#152, R19#56, R19#344, R19#345, R19#346, R19#394,
R19#395, R19#396, R19#397**
Marshall - R6#57, R13#120, R13#172, R13#173
Martel - R7#139, R9#19, R9#20, R11#16
**Martin - R1#203, R1#204, R1#205, R1#206, R1#207, R6#93, R10#65, R16#150, R16#153,
R18#171, R18#229, R18#384, R18#385, R18#386. R19#4, R19#280, R19#287**
Martineau - R12#104
**Masse - R1#572, R1#573, R1#574, R9#73, R9#74, R17#252, R18#308, R18#361, R19#258.
R19#259, R19#260, R19#261, R19#262, R19#263**
Mathieu - R1#136
Mathurin - R5#20, R7#125, R7#129, R13#149, R15#113, R15#116
Maynard - R2#11, R18#321
McCabe - R18#227
McCafferty - R9#120, R9#121
McCarthy - R4#54, R4#58, R4#59, R7#121, R7#122
McDermott - R18#36
**McDuff - R7#44, R7#45, R7#46, R7#47, R7#48, R7#49, R7#50, R7#51, R19#105, R19#144.
R19#146, R19#486, R19#487**
McElhinny - R19#220, R19#221
McFarlane - R18#218
McGahey - R15#1, R15#2
McGlenn - R17#167
McGrade - R1#240
McGuire - R9#120
McKay - R17#151, R17#152, R17#155
McKinley - R3#26

McKinney - R18#50, R18#51
McLemore - R12#125
McMackin - R17#44
McMahon - R2#8, R5#19, R11#37, R11#38, R11#39, R11#40, R11#41, R11#42, R11#43, R11#93, R15#73
McManus - R7#16, R7#17, R7#18, R7#19, R7#20, R11#46, R11#47, R13#85, R13#86, R13#87
McNeil - R19#376
Mehlhorn - R6#94
Melanson - R10#72
Melonson - R1#133
Menard - R1#334, R1#336, R1#399, R1#544, R1#545, R1#546, R3#41, R4#31, R4#35, R12#1, R12#2, R12#93, R12#94, R12#95, R12#96, R14#7, R15#90, R15#91, R15#92, R16#74, R16#76, R16#77, R16#78, R16#79, R16#151, R16#232, R16#233, R16#234, R17#189, R17#225, R17#226, R18#103, R18#116, R18#211, R18#292, R18#430, R18#506, R19#44, R19#45, R19#46, R19#135, R19#136, R19#137, R19#138, R19#139, R19#140, R19#222, R19#270, R19#272, R19#274, R19#308, R19#309, R19#310, R19#311, R19#362, R19#476
Mendes - R1#417, R18#213, R18#403
Mercier - R1#122, R9#24, R13#9, R13#13, R19#164
Merritt - R18#395
Merryman - R17#35
Mertz - R18#77
Messier - R1#101, R1#239, R1#403, R1#404, R1#405, R1#406, R1#592, R7#44, R15#3, R16#82, R16#83, R16#84, R16#85, R16#86, R16#87, R17#138, R17#177, R17#184, R17#185, R17#186, R17#187, R17#188, R18#331, R18#332
Metivier - R1#141, R1#142, R1#143, R1#144
Meunic - R12#38
Michaud - R1#44, R1#319, R1#374, R1#426, R1#451, R1#452, R1#513, R1#598, R1#610, R1#612, R1#613, R6#23, R7#26, R9#31, R9#225, R10#39, R12#43, R12#106, R12#114, R12#115, R12#116, R12#119, R12#120, R13#36, R13#37, R13#38, R13#39, R15#103, R15#180, R16#57, R16#58, R16#154, R16#163, R16#195, R16#221, R17#54, R17#55, R17#56, R17#57, R17#58, R17#59, R17#225, R17#226, R17#227, R17#253, R17#254, R18#135, R18#144, R18#145, R18#146, R18#233, R19#91, R19#99, R19#144, R19#145, R19#159, R19#160, R19#161, R19#162, R19#224, R19#228, R19#327, R19#406, R19#407, R19#408, R19#409, R19#410, R19#411
Michel - R1#307, R1#309
Miklos - R1#264
Milanoski - R10#33
Millard - R16#24
Miller - R1#565, R11#56
Milton - R1#323, R3#43
Mitchell - R1#23, R1#591
Modwina - R14#10, R14#11
Moens - R1#16
Moeykens - R18#230
Moffett - R1#346, R1#347
Monaghan - R13#90
Mongeon - R5#3, R5#5
Monroe - R11#58

Montini - R10#76
Monzerolle - R13#117, R13#118, R13#119
Moore - R9#159, R18#44, R18#198, R18#199, R19#128
Morais - R5#60, R18#369, R18#370, R18#374
Moreau - R6#5, R6#6, R6#7, R7#21, R9#122, R16#13, R16#14, R16#15, R16#64, R16#118,
R19#53, R19#54, R19#55, R19#56, R19#57, R19#63, R19#64, R19#65
Morgan - R9#21
Morin - R1#11, R1#87, R1#88, R1#273, R1#274, R1#368, R1#400, R1#416, R6#8, R6#39, R9#9,
R9#22, R9#134, R9#135, R10#12, R12#51, R12#97, R12#99, R13#57, R13#64, R13#91,
R13#163, R15#7, R15#90, R16#51, R16#75, R16#177, R17#4, R17#5, R17#6, R17#7,
R17#8, R17#9, R17#10, R17#11, R17#12, R17#13, R17#77, R17#114, R17#115, R17#116,
R17#117, R17#118, R17#168, R17#169, R18#81, R18#325, R18#411, R18#422, R19#79,
R19#82, R19#83, R19#84, R19#85, R19#106, R19#107, R19#135, R19#136, R19#312
Morneau - R18#337
Morneault - R17#22
Morreau - R13#96
Morrill - R1#532
Morris - R10#54
Morrisette - R18#289
Mortimer - R15#121
Mosher - R18#421
Mosko - R15#161
Moss - R4#72, R4#75
Motard - R13#26, R13#30
Muhleib - R17#78
Muir - R7#157, R7#158, R15#46
Mulligan - R1#607, R1#608
Mullin - R18#465
Murch - R10#66
Murillo - R18#274
Murphy - R12#66, R17#122
Mutty - R5#21, R5#23, R7#54, R7#55, R7#57, R7#58, R7#59, R11#75, R11#77
Myska - R1#218, R1#220
Nadeau - R1#42, R1#43, R1#453, R1#454, R9#27, R9#30, R9#63, R9#176, R9#177, R12#49,
R15#55, R16#55, R16#144, R17#239, R17#240, R17#241, R19#219
Neagle - R7#61, R7#124, R11#26
Neeld - R18#260
Neron - R6#73, R6#74
Newton - R1#448, R18#42
Nicita - R18#38
Nickerson - R1#152
Niles - R17#72, R17#73, R17#74
Noel - R18#183
Nolan - R18#273
Nomine - R14#14
Normand - R1#288, R1#506, R1#524, R1#525, R1#526, R3#13, R3#14, R3#15, R3#16, R7#39,
R7#40, R7#94, R7#95, R8#26, R9#162, R12#29, R12#30, R12#31, R12#32, R12#33,
R12#34, R12#35, R12#129, R16#57, R16#58, R16#59, R16#62, R16#90, R16#91, R16#93.

(Normand Cont'd.)

R16#94, R16#95, R18#89

Nutt - R18#284

Obrin - R9#33

O'Brin - R17#176

Ogden - R1#448, R1#449

O'Leary - R15#1

Oliver - R1#267

O'Meara - R18#77

O'Neil - R4#90, R12#111, R12#112

Opril - R8#17

Oravetz - R18#181, R18#182

Orne - R1#508, R9#179

O'Toole - R18#269

Ouellet - R16#101, R16#106, R16#107, R19#476

Ouellette - R1#154, R1#155, R1#262, R1#270, R1#325, R1#490, R1#495, R4#4, R5#61, R5#68, R6#40, R6#64, R6#65, R7#44, R7#46, R9#3, R9#17, R9#72, R11#48, R11#53, R11#54, R11#121, R11#123, R11#124, R11#125, R11#126, R11#127, R15#9, R16#75, R16#133, R16#134, R16#196, R17#102, R17#248, R18#7, R18#17, R18#18, R18#20, R18#21, R18#29, R18#420, R18#421, R19#78, R19#113, R19#208, R19#209, R19#220, R19#258, R19#259, R19#496

Ouimet - R9#32

Owen - R1#489

Owens - R12#59, R12#61

Page - R8#18, R15#99

Packard - R1#133

Pagurko - R4#7, R4#8, R4#9

Paiement - R9#199, R11#86, R11#87, R11#129, R16#178, R17#135, R17#136, R17#223

Paiment - R16#162

Painchaud - R1#358, R2#6, R3#17, R3#18, R3#19, R3#20, R3#21, R3#22, R6#29, R6#30, R7#44, R7#49, R16#89

Palmer - R11#113, R11#114

Palozzi - R17#14, R17#15, R17#16

Paquet - R1#15, R15#67, R15#68

Paquette - R1#38, R1#498, R1#499, R1#518, R1#519, R1#622, R7#70, R7#71, R7#72, R7#73, R9#40, R9#41, R9#42, R15#146, R15#150, R16#112, R16#116, R18#59, R19#61, R19#62, R19#233

Paquin - R8#36

Paradis - R1#135, R1#169, R1#170, R1#171, R1#172, R1#173, R1#174, R1#389, R1#390, R1#391, R1#486, R1#553, R1#555, R4#64, R4#65, R4#67, R6#83, R8#12, R11#2, R11#49, R11#50, R11#51, R12#28, R12#35, R12#100, R12#101, R12#103, R13#159, R14#2, R16#189, R16#190, R18#192, R19#135, R19#138, R19#175, R19#460, R19#461

Parent - R11#135, R11#136, R11#137, R12#28, R12#124, R13#79, R13#80

Pascal - R9#133

Paskoski - R1#359

Pelkey - R18#86

Pellegrini - R1#583, R1#584

Pellerin - R16#120, R16#122, R16#176

Pelletier - R1#6, R1#41, R1#100, R1#149, R1#150, R1#151, R1#152, R1#193, R1#251, R1#523,
R1#569, R1#604, R4#89, R6#1, R6#2, R6#17, R6#36, R6#95, R6#96, R7#7, R9#56,
R9#79, R9#80, R9#198, R10#56, R10#58, R15#47, R15#48, R18#26, R18#27, R18#28,
R18#131, R18#158, R18#159, R18#234, R18#235, R18#282, R18#298, R18#282,
R18#435, R19#130, R19#132, R19#224, R19#225, R19#226, R19#227, R19#228,
R19#229, R19#230

Pellitier - R9#86

Peltier - R8#13

Pepin - R9#64, R18#2

Perdue - R11#60

Perez - R18#419

Perreault - R7#126, R7#127, R7#128, R9#101, R9#102, R18#47

Perry - R5#59

Peters - R9#34

Peterson - R12#50

Petit - R5#31

Pflaume - R18#439

Pharris - R7#65

Philippon - R1#281, R1#364, R1#366, R1#420, R1#422, R1#423, R1#424, R2#15, R5#54, R5#55,
R5#56, R5#57, R5#58, R16#161, R17#184, R17#186, R18#57, R18#126, R18#375,
R18#413, R18#449

Picard - R2#29, R3#29, R3#32, R3#33, R6#38

Piche - R19#384

Pinard - R18#286

Pinette - R1#232, R1#338, R1#456, R1#457, R12#41, R17#47, R17#213, R18#1, R18#52,
R18#114, R18#115, R18#124, R18#125, R18#132, R18#133, R18#134, R18#474,
R18#483, R19#104, R19#402, R19#403, R19#404, R19#405

Pinnette - R1#561

Piuze - R1#557, R18#228

Plante - R11#53

Plourde - R1#191, R1#192, R1#243, R1#560, R7#69, R11#121, R15#120, R16#204. R18#442.
R19#496, R19#497

Plourde - R1#191, R1#192, R1#243, R1#560, R7#69, R11#121, R15#120, R16#204. R18#442.
R19#496, R19#497

Plympton - R17#157

Poirier - R1#190

Postras - R3#1, R3#2, R6#52, R11#101, R13#25, R15#95, R16#175, R17#46, R17#248. R18#328.
R18#329

Poliquin - R1#159, R6#66, R6#67, R6#68, R6#69, R6#70, R6#71, R16#160

Pomerleau - R9#88

Pooler - R1#22

Potter - R18#296

Potvin - R6#45, R18#33

Poulin - R1#310, R1#552, R7#139, R11#128, R11#129, R11#130, R15#181, R15#182, R17#182.
R17#183, R18#460

Pouliot - R7#85, R7#86, R7#87, R7#88, R7#89, R9#6, R17#23, R18#488, R18#489, R19#179.
R19#181, R19#182, R19#183

Powers - R1#58

Pratt - R18#407
Prescott - R18#121
Priestly - R1#417, R1#418, R1#419
Provencher - R19#147
Provost - R1#616, R9#127
Pruell - R18#112, R18#113
Purington - R1#208, R1#209, R1#210
Purinton - R4#61, R4#63
Quagliaroli - R18#169, R18#170, R18#195, R18#205
Racine - R1#169, R1#171, R1#313, R1#314, R1#315, R1#316, R1#543, R4#92, R4#93, R4#94, R4#95, R4#96, R4#97, R4#98, R6#23, R7#34, R9#123, R9#126, R9#179, R12#127, R12#128, R15#12, R15#13, R15#16, R15#17, R15#18, R15#19, R15#20, R15#21, R15#22, R15#26, R16#82, R16#85, R17#100, R17#101, R18#311, R18#312, R18#324, R19#496
Radcliffe - R18#417
Ragot - R12#108
Ramey - R20#8
Ramsey - R5#1
Randall - R18#30
Raymond - R1#496, R1#523, R1#568, R1#569, R1#570, R2#16, R18#202, R18#457, R18#458
Rector - R10#3
Reddy - R18#351
Regan - R8#14
Rehfield - R18#313
Reid - R13#52, R13#53, R13#54, R13#55
Remy - R14#5
Renard - R8#9
Renaud - R1#84, R7#109, R8#3, R9#7, R9#181, R19#95, R19#294
Rich - R18#348, R18#349
Richard - R1#7, R1#16, R1#38, R1#199, R1#301, R1#527, R1#571, R1#614, R6#78, R9#45, R9#90, R9#91, R9#92, R9#165, R9#166, R10#80, R13#1, R13#110, R13#111, R13#112, R13#113, R13#114, R13#115, R13#164, R13#165, R13#166, R13#167, R13#168, R16#53, R16#205, R16#206, R16#207, R16#208, R16#209, R16#210, R17#137, R19#130, R19#133, R19#134, R19#295, R19#296, R19#297, R19#298
Richards - R1#45, R1#46, R1#47, R1#92, R1#164, R2#12, R6#57, R10#63
Riendeau - R1#113, R1#238, R13#97, R18#214, R18#261, R18#262, R18#426
Rigolizzo - R1#159
Ringrose - R13#159
Ringuette - R15#53, R16#101, R16#104
Ritchie - R1#482, R1#504, R13#46, R13#48, R13#49, R13#50
Robertson - R16#124
Robinson - R1#609, R19#200, R19#201, R19#202
Rochefort - R12#89, R12#90, R19#98
Rodrigue - R6#18, R18#345, R19#309
Rodrique - R17#29
Rodriquez - R10#46
Rogers - R18#359, R18#360
Rondeau - R13#35
Rooney - R7#159, R10#35

Rose - R10#2

Ross - R1#264, R1#265

Rossignol - R1#138, R17#190

Rote - R1#278

Rousseau - R6#45, R9#18, R9#143, R9#144, R9#145, R9#147, R9#148, R15#113, R18#104,
R18#105

Roux - R16#75

Roy - R1#60, R1#61, R5#67, R6#16, R6#49, R7#82, R9#18, R9#151, R10#77, R13#73, R13#159,
R15#181, R15#182, R15#183, R15#184, R15#185, R18#263, R18#322, R19#10, R19#266

Ruest - R1#73, R12#126, R13#26, R13#27, R13#28, R13#29, R13#31, R15#137, R15#138,
R15#139, R15#140, R18#66, R19#216, R19#217

Rush - R1#154, R1#164

Russell - R9#135

Russett - R18#284

Russo - R1#128

Rutelle - R8#27

Saindon - R1#26, R1#27, R1#28, R1#402, R1#403, R1#404, R1#483, R1#484, R1#485, R3#4,
R3#5, R11#88, R11#89, R11#90, R11#91, R11#92, R13#19, R13#22, R13#23, R13#24,
R17#161

St. Jean - R18#201

St. Laurent - R4#46, R4#47, R4#48, R4#49, R13#126, R15#50, R18#440, R19#117, R19#118

St. Onge - R1#14, R1#59, R1#75, R1#76, R1#190, R1#548, R1#549, R6#14, R7#70, R7#72,
R12#13, R14#15, R15#60, R15#86, R15#87, R15#88, R15#89, R16#201, R16#202,
R16#203, R18#453, R17#1, R17#2, R17#3, R18#454

St. Pierre - R1#229, R1#243, R1#292, R1#344, R1#345, R1#348, R1#349, R1#395, R1#396,
R1#397, R1#408, R1#423, R1#424, R1#488, R1#535, R1#575, R1#576, R1#592, R4#4,
R4#5, R5#46, R5#54, R5#56, R6#35, R6#38, R6#54, R7#84, R7#130, R7#131, R7#132,
R9#9, R9#48, R9#49, R9#50, R9#128, R9#155, R9#178, R10#52, R10#61, R10#62,
R11#18, R11#36, R11#121, R12#35, R12#36, R13#36, R13#103, R13#106, R13#107,
R13#109, R15#61, R15#62, R15#63, R15#64, R15#65, R15#67, R15#68, R15#69, R15#91,
R16#100, R16#146, R16#147, R16#148, R16#181, R16#184, R16#185, R16#186,
R16#187, R17#134, R17#191, R18#236, R18#239, R18#275, R18#276, R18#291,
R18#404, R18#405, R18#406, R19#23, R19#38, R19#191, R19#192, R19#193, R19#194,
R19#195, R19#196, R19#198, R19#223, R19#252, R19#277, R19#278, R19#307,
R19#313, R19#348, R19#353, R19#435, R19#436, R19#445

Sallea - R1#275, R1#276

Santerre - R1#475

Saucier - R1#8, R1#41, R1#258, R1#260, R1#520, R9#86, R15#99, R18#178, R18#193, R18#468,
R19#171

Saunders - R1#9, R1#12

Savard - R8#17

Savoie - R16#145, R18#249

Sawyer - R1#98, R1#99, R1#146, R1#567, R4#50, R4#51, R4#52, R4#53, R4#83, R4#84, R7#54,
R7#56, R7#60, R9#39

Schaedler - R19#34

Schinck - R13#131, R13#132, R19#190, R19#198, R19#199, R19#299

Scott - R10#7

Senecal - R4#1, R4#3, R4#13, R4#14, R4#15, R4#16, R17#242

Sarvey - R8#33
Shannon - R16#224
Shaw - R19#39
Shubman - R1#263
Seward - R17#221, R17#222
Simpson - R9#215, R13#87, R16#220, R19#57
Skaling - R1#562, R1#563, R1#564
Skolfield - R1#91
Small - R1#199, R17#128
Smart - R1#534, R18#336
Smiley - R1#107, R1#108
Smith - R1#240, R6#82, R16#96, R17#162, R17#163, R18#487
Smythinsky - R10#74
Snowdon - R16#88
Sophonie - R14#10, R14#13
Soucie - R1#97, R18#223
Soucy - R12#28
Spence - R1#466
Stamas - R18#322, R18#323, R18#346
Stedman - R13#114
Ste. Marie - R12#125
Stebbins - R15#34, R15#35, R15#36, R15#37, R15#39, R15#40
Steiner - R18#431
Stetson - R18#423
Stevens - R17#51
Stewart - R6#20, R6#21
Strahl - R17#220
Strange - R4#29, R18#4, R18#138
Stuart - R13#40, R13#41, R13#42
Stubbs - R4#89
Stupinski - R18#272
Suave - R18#309
Sundquist - R2#21
Sutton - R17#250, R17#251
Swainbank - R10#31
Sweeney - R17#249
Szurgot - R10#50
Talbot - R1#319, R1#512, R4#60, R4#64, R17#22, R17#140, R19#19
Tardif - R2#30, R9#17, R9#74, R13#20, R13#21, R15#78, R15#150, R19#378, R19#380
Tardiff - R1#536, R2#7, R9#184, R12#13, R15#79, R15#80, R17#23, R17#167
Temple - R5#66
Tenneson - R4#26
Tessier - R18#82
Tetreault - R1#546, R9#104, R9#106, R9#107, R12#43, R17#107, R19#113, R19#114, R19#115,
R19#116, R19#416, R19#422, R19#440, R19#441, R19#442, R19#443, R19#444
Tetu - R1#101, R1#367, R7#150, R7#151, R16#121, R16#149
Thalheimer - R12#67, R12#73

Theberge - R1#619, R11#106, R12#82, R12#84, R12#86, R13#59, R13#61, R15#141, R15#142, R15#143, R15#144, R15#145, R15#146, R15#147, R15#148, R15#149, R15#160, R15#161, R15#162, R15#163, R15#164, R15#165, R15#166, R15#170, R15#171, R15#172, R15#173, R15#174, R15#181, R15#183, R16#1, R16#2, R16#3, R16#100, R17#38, R17#39, R17#40, R17#41, R17#42, R17#43, R17#44, R18#48, R18#65, R19#79, R19#84

Theriacult - R9#46

Therrien - R16#55, R16#141, R19#362

Thibault - R1#513, R7#34, R7#35, R12#122, R13#81, R15#95, R15#96, R15#97, R15#98, R16#1, R16#2, R16#11, R16#12

Thibeault - R1#439, R1#440, R1#620, R6#92, R7#4, R7#82, R9#54, R9#123, R9#124, R9#125, R9#126, R9#167, R10#8, R10#9, R13#75, R13#76, R13#77, R13#78, R13#82, R13#83, R15#15, R15#84, R15#85, R15#103, R15#108, R16#19, R16#164, R16#165, R16#215, R16#218, R17#119, R17#120, R17#121, R17#123, R18#88, R18#143, R18#186, R18#210, R18#305, R18#326, R18#327, R18#342, R18#410, R18#433, R18#434, R18#481, R19#96, R19#97, R19#144, R19#267, R19#268

Thibodeau - R9#3, R18#71, R18#72, R18#310, R18#376, R18#377, R18#463, R18#464, R19#66, R19#184, R19#428, R19#488, R19#491

Thiboutot - R1#86, R13#100, R13#101, R17#238, R18#150, R18#151, R18#155, R18#280, R18#391

Thomas - R18#450

Thompson - R1#586

Thornton - R18#140

Tomko - R1#229, R1#230, R9#179

Tondreau - R1#400, R1#401, R6#13, R6#23, R9#10, R16#72, R16#73, R16#112, R16#113, R16#114, R16#115, R16#116, R17#75, R17#76, R17#77, R19#60, R19#165, R19#167, R19#473

Toothaker - R7#88, R18#5, R18#6

Toth - R4#87, R4#91, R19#462, R19#463, R19#464, R20#5

Tougas - R6#58, R6#59, R6#60

Tourigny - R1#290, R1#291

Tourtlotte - R1#250

Tracey - R15#129

Tracy - R15#131

Tremblay - R1#121, R1#572, R1#573, R6#16, R6#37, R7#27, R7#28, R9#23, R9#65, R11#102, R13#17, R13#98, R17#18, R17#19, R18#283, R18#473, R18#503, R19#15, R19#264, R19#265, R19#280, R19#283

Trembley - R15#123, R19#66, R19#218

Trepanier - R1#611

Troup - R16#117

Truchon - R7#111

Trudeau - R12#52, R12#53, R12#54, R12#55, R12#56, R12#57, R12#58, R12#125

Trudell - R18#432

Trusiani - R1#461, R1#462

Tupper - R19#478, R19#479, R19#480

Turcotte - R1#148, R1#231, R3#6, R3#11, R16#111, R19#277, R19#279

Urban - R19#64

Vachon - R1#141, R1#143, R1#239, R3#29, R3#30, R3#31, R3#34, R6#28, R8#38

Vallancourt - R1#441, R1#442, R7#123
Vandall - R13#108, R13#116
Vannette - R1#615, R4#12, R4#82, R7#99, R13#153, R13#154, R13#155, R13#156, R13#157,
R13#158, R16#11, R19#361, R19#488
Viel - R1#139
Vigant - R1#371, R18#426
Vincent - R18#147, R18#154
Viney - R1#307, R1#308, R1#309, R1#319, R8#19, R9#191
Violette - R18#424
Voisine - R1#74
Waddington - R12#81
Wallace - R19#451
Walsh - R9#157, R15#14
Ward - R1#12, R18#80
Was - R11#106
Weber - R18#257
Weeks - R1#125
Welch - R1#595
White - R1#413, R1#414, R1#514, R1#515, R9#210, R13#52, R19#315
Wicherski - R4#27
Wilson - R1#83, R2#10, R18#60, R18#61
Wing - R1#621
Wole - R8#15
Wolfe - R18#401, R18#402
Wrenn - R18#459
Yacano - R18#330
Yakubowski - R19#35
Yanok - R1#361, R1#362, R1#363
Yates - R18#270
York - R1#112
Young - R7#12, R18#339
Zazeski - R18#75
Zignego - R2#3