



ParisTech



**PARISTECH – CSC  
PHD PROGRAM**

NOVEMBER 8, 2022

# Presentation – table of content 1/2

## 1. ParisTech Introduction

## 2. ParisTech – CSC PhD Program

Applicant's profile  
Calendar and steps

## 3. Research in ParisTech's schools

**Excellence in research**

**Research domains**

**Arts et Métiers Sciences et  
Technologies**

**Chimie ParisTech – PSL**

**École des Ponts ParisTech**

**ESPCI Paris – PSL**

**Institut d'Optique Graduate School**

**Mines Paris – PSL**

# Presentation – table of content 2/2

## 4. Labs and PhD proposals

### Arts et Métiers Sciences et Technologies

Laboratoire Bourguignon des Matériaux et Procédés (LABOMAP)  
Laboratoire angevin de mécanique, procédés et innovation (LAMPA)  
Laboratoire d'Ingénierie des Systèmes Physiques et Numériques (LISPEN)  
Laboratoire de mécanique des fluides de Lille (LMFL)  
Laboratoire de Conception Fabrication Commande (LCFC)  
Laboratoire conception de produits et innovation (LCPI)  
Laboratoire Microstructures Mécanique Matériaux (LEM3)  
Laboratoire Ingénierie des Fluides Systèmes Energétiques (LIFSE)  
Mechanics, Surfaces and Materials Processing (MSMP)  
Institute of Mechanics and Mechanical Engineering (I2M)  
Laboratoire de dynamique des fluides.(DynFluid)

### Chimie ParisTech - PSL

I-CleHS laboratory- SEISAD TEAM  
IRCP - Institut de Recherche de Chimie de Paris

### Ecole des Ponts ParisTech

Navier Laboratory  
LIGM - Laboratoire d'Informatique Gaspard Monge

### ESPCI Paris – PSL

Chimie, Biologie et Innovation (CBI)  
GULLIVER  
Institut Langevin  
Laboratoire de Physique et d'Etude des Matériaux (LPEM)  
Physique et mécanique des Milieux Hétérogènes (PMMH)  
Plasticité du cerveau

### Institut d'Optique Graduate School

Laboratoire Photonique, numérique et nanosciences (LP2N)

### Mines Paris – PSL

CRI – Centre de Recherche en Informatique  
CAOR – Centre de Robotique

# Webinar GUESTS



Arts et Métiers Sciences et Technologies – Ali Siadat, scientific advisor for China at Arts et Métiers  
Arts et Métiers Sciences et Technologies – LIFSE : Samir Garbaya  
Arts et Métiers Sciences et Technologies – LISPEN Lab: : Jean-Philippe Pernet, Nathalie Klement, Ruding Lou, Frédéric Mérienne, Mathias Kleiner, Arnaud Polette, Lionel Roucoules, Esmâ Yahia, Pierre Garambois, Florian Huet  
Arts et Métiers Sciences et Technologies – Laboratoire de Mécanique des Fluides de Lille : Francesco Romano, Shuo Liu, HuiWang  
Arts et Métiers Sciences et Technologies – LAMPA : Sylvain Fleury, Simon Richir  
Arts et Métiers Sciences et Technologies – MSMP : Mourad Elhadrouz, Jean-Patrick Goulmy, Dorian Depriester  
Arts et Métiers Sciences et Technologies – LABOMAP : Louis Denaud, Mariem Yaich, Stéphane Girardon



Chimie ParisTech – PSL – Ilaria Ciofini, VP Research  
Chimie ParisTech – PSL – IRCP : Dominique Costa  
Chimie ParisTech – PSL – I-CleHS : Anne Varenne , Jean-François Soulé



Ecole des Ponts ParisTech – YuJun Cui, Research deputy director  
Ecole des Ponts ParisTech – Laboratoire NAVIER : YuJun Cui



ESPCI Paris – PSL – Joshua McGraw  
ESPCI Paris – PSL – LPEM : Zhuoying Chen, Cheryl Feuillet-Palma, Lionel Aigouy  
ESPCI Paris – PSL – GULLIVER : Joshua McGraw  
ESPCI Paris – PSL – CBI : Annie Colin



Mines Paris– PSL – Alexandra Belus, scientific advisor for China at Mines Paris  
Mines Paris – PSL – CRI - Claude Tadonki  
Mines Paris – PSL – CAOR -Alina Glushkova



Institut d'Optique Graduate School – Denis Boiron, Deputy head of Doctoral School Waves and Matter (EDOM)  
Institut d'Optique Graduate School – LP2N : Philippe Tamarat , Dylan Banahene-Sabulsky



©Chimie ParisTech - PSL



©École des Ponts ParisTech

# 1. ParisTech introduction

# ParisTech schools

7

« Grandes Écoles »  
In Engineering &  
Science

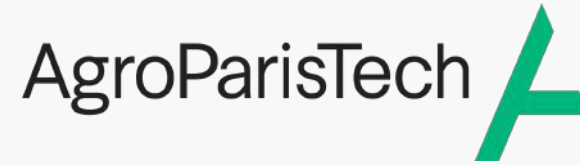

# ParisTech – a brand for excellence in France

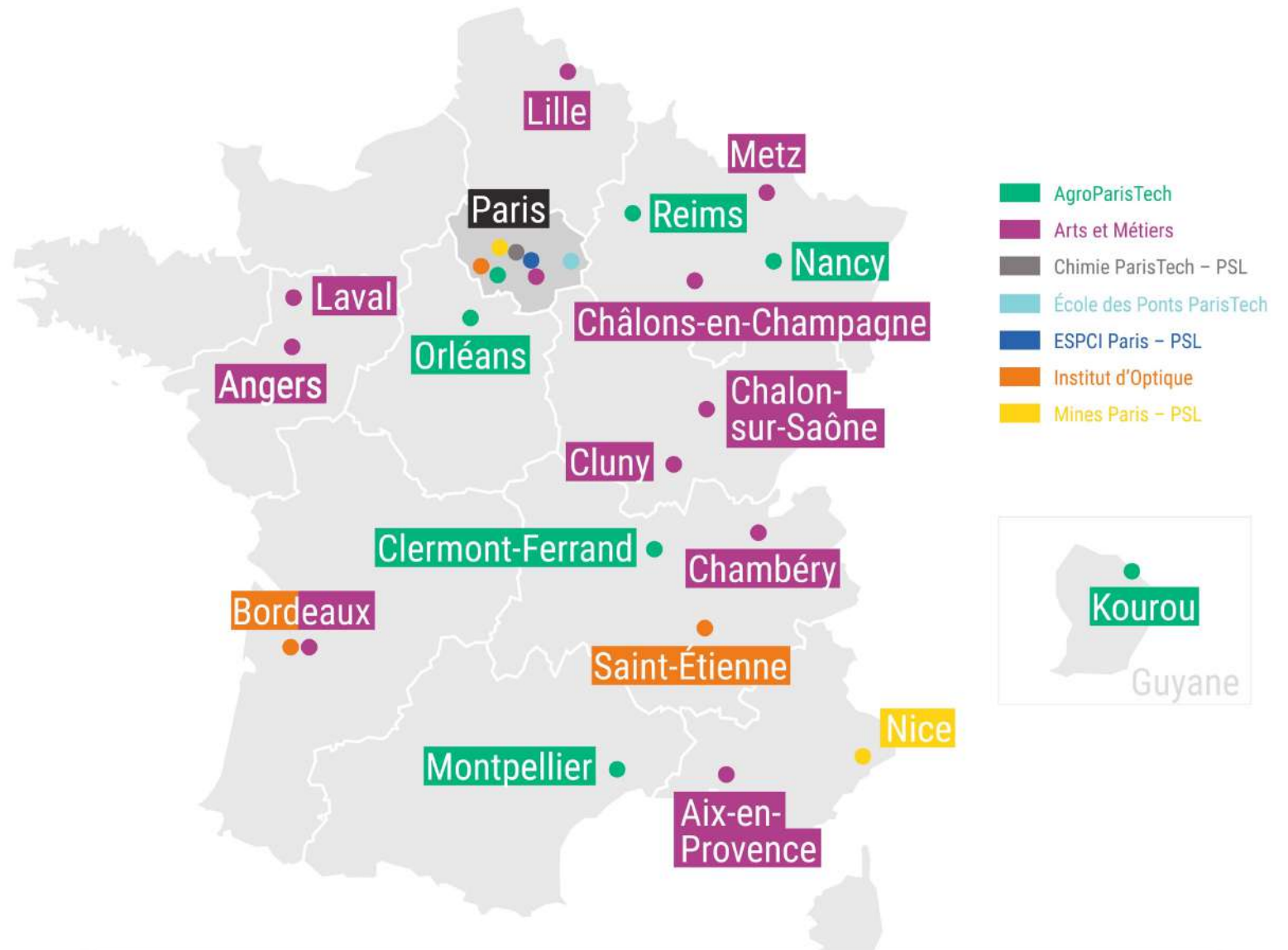

The 7 schools' laboratories are located all around France, not only in Paris.

# ParisTech's consortium key numbers



12 500  
students



1 700  
PhD candidates



70 international  
agreements



85 laboratories



1 500  
professors



30%  
international students



90 000  
alumni





# Leaving a mark in history...



## Molecular cuisine

Hervé This & Nicholas Kurti (1988)

*AgroParisTech*



## Quartz clock

Marius Lavet (1949)

*Arts et Métiers*

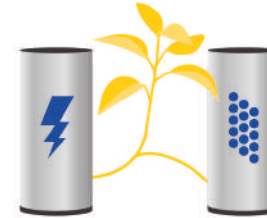

## Catalytic methanation reactor

Vincent Piepiora (2018)

*Chimie ParisTech - PSL*



## Lenticular device for video projectors, headlights lighting and some photovoltaic cells

Augustin Fresnel (1822)

*École des Ponts ParisTech*

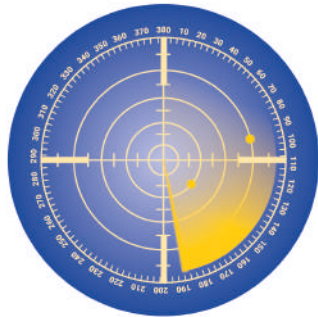

## Sonar

Paul Langevin (1915)

*ESPCI Paris - PSL*



## Progressive lenses for visual correction

Bernard Maitenaz (1959)

*Institut d'Optique Graduate School*

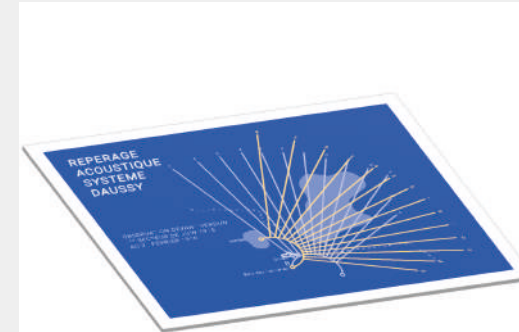

## Sound-based tracking system

Ferdinand Daussy (1915)

*MINES Paris - PSL*

# Permament connections with companies

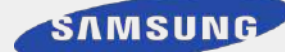

# ParisTech alumni – key players of the economic world



**Philippe Knoche**

MINES Paris - PSL



**Antoine Frérot**

École des Ponts ParisTech



**Benoît de Ruffray**

École des Ponts ParisTech



**Christel Heydemann**

École des Ponts ParisTech



DS AUTOMOBILES

**Béatrice Foucher**

AgroParisTech

**WITHINGS**

**Éric Carreel**

ESPCI Paris - PSL

**BlaBlaCar**

**Nicolas Brusson**

Institut d'Optique Graduate School

**THALES**

**Patrice Caine**

MINES Paris- PSL

**VINCI**

**Xavier Huillard**

École des Ponts ParisTech



**Jean-Marc Chéry**

Arts et Métiers



**Éric Niedziela**

Arts et Métiers



**Marion Dewagenaere**

École des Ponts ParisTech



**Jean-Laurent Bonnafé**

MINES Paris - PSL



**Anne Rigail**

MINES Paris - PSL



**Mostafa Terrab**

École des Ponts ParisTech



**Laurence Piketty**

Chimie ParisTech - PSL



**Jean-Philippe Puig**

Chimie ParisTech - PSL

# ... or to create your start-up



Breeding and processing insects to contribute to the major challenges of our time: feeding the world's population, preserving resources and biodiversity, and fighting global warming



Zozio turns a factory into a connected factory with its Robin.Connect service. Robin.Connect makes your data speak through its collection, structuring, storage and protection.



Aza Battery is developing new systems by improving all components (bi-functional air electrodes, separating membrane and zinc electrode)



Canopy solutions to cover the city's landscape with a modular, reversible, natural and light-weight vegetation mesh



Ultrasound medical imaging  
An innovative medical technology company primarily focused on improving women's health and well-being through early detection and treatment



EFFILUX specializes in designing, manufacturing and selling powerful, flexible and easy-to-use LED lighting solutions for machine vision, quality control, scientific imaging, biomedical, optical measuring devices, and many other applications.



Legalstart is leader in online legal and administrative services for start-ups, SMEs and associations



# Why choose France?

# Excellence in S&T and business



©Arnaud Bouissou / Terra



©Daniel Coutelier / Terra



©Arnaud Bouissou / Terra

- **6<sup>th</sup> economic power in the world**
  - R&D spending = 2.2% of GDP
  - International company leaders in their sector (materials, building, cosmetics, energy, transport...)
  - Paris area: a dynamic region (a lot of companies, high employability rate, numerous R&D centers)
  - Anation of entrepreneurs: 3.5 days to create a business in France
- **Excellence of the Higher Education system**
  - 5<sup>th</sup> destination in the world for international students
  - Scholarships and support for international mobility
  - A lot of international academic partners
  - Tuition fees lower than in most of the Western countries
- **A S&T leader worldwide**
  - The country of mathematicians (Viète, Laplace, Cauchy, Poincaré, Louis Bachelier...)
  - Excellence in a lot of domains, e.g. chemistry, civil engineering, physics (Marie & Pierre Curie, Ampère, Laplace, Freyssinet, Coriolis, Fourier...)
  - 65 Nobel prizes and 13 Fields Medals
  - World famous research organizations (CNRS, INRAE, INSERM, CEA...)

# A country of culture



- **Tradition / Art & History / Quality of Life**
  - Arts (museums, movies, literature, philosophy...)
  - Romanticism, impressionism, surrealism...
  - Food
- **Values**
  - Freedom, equality, brotherhood
  - Inclusion
  - Cosmopolitanism
  - Critical thinking, strong attachment to sciences and innovation
- **A key role in ecological transition and climate change**
- **French language**
  - Official language of more than 300 million people (5<sup>th</sup> in the world)
  - 3<sup>th</sup> most important language for business in the world after English and Mandarin Chinese

## *What international students are saying*

- *9 out of 10 international students recommend France as first study destination*
- *93 % believe that studying in France has been a self-enrichment*
- *86 % believe that studying in France have highlighted their university curriculum*





©Fethi Bedioui

## 2. ParisTech – CSC PhD program

# Applicant's Profile

# Prerequisites

Find all relevant information on:



Applicants must be citizens of the People's Republic of China at the time of application.

Applicants should not hold a foreign permanent residence permit.  
Applicants should be at least 18 years old at the time of application.

## STUDYING IN CHINA

- At final year of Master degree
- In the 1st PhD year, recommended by your home university (for co-supervised PhD)

## STUDYING IN FRANCE (OR IN ONE OF THE 41 PARTNER COUNTRIES OF THE CSC)

- Second/Last year Master's (M2) students or students graduated within less than a year at the time of application for the CSC scholarship.
- *Applicants who have studied for a “Diplôme d'ingénieur” in France, and especially those who have received funding from the [CSC - ParisTech "9+9" Program](#) project are also encouraged to apply to this PhD program.*

## WORKING

You are a **master holder** and you work in a company that agrees with your PhD project

# Prerequisites:

Excellence, for a highly-selective competition

- You have **excellent academic records, especially in the relevant discipline.**
- You should have **good command of written and spoken English.**
- **You should have a coherent personal and professional plan.**
- You are willing to learn minimal French for basic communication.



## Tips

- *Learn as much as you can about the labs, the PhD advisors, their past and present work.*
- *Carefully select PhD proposals that are relevant with your personal profile.*
- *Then build a coherent, clear professional plan around the information you gather.*

# The CSC scholarship – funding scheme

- 1350€ / month (for the duration specified on your admission letter, starting when you arrive in France) + one-time round-trip international travel expenses by the most economical route
- Duration :
  - 36-48 months for full PhD
  - 6-24 months for co-supervised PhD
- You are committed to go back to China at then end of your PhD (exceptions to be found on the CSC website).

# Calendar & Steps

# Where to find relevant information?

## PARISTECH WEBSITES

<https://www.paristech.fr/en/homepage>

To learn more about the ParisTech – CSC PhD program, about the ParisTech labs, etc.

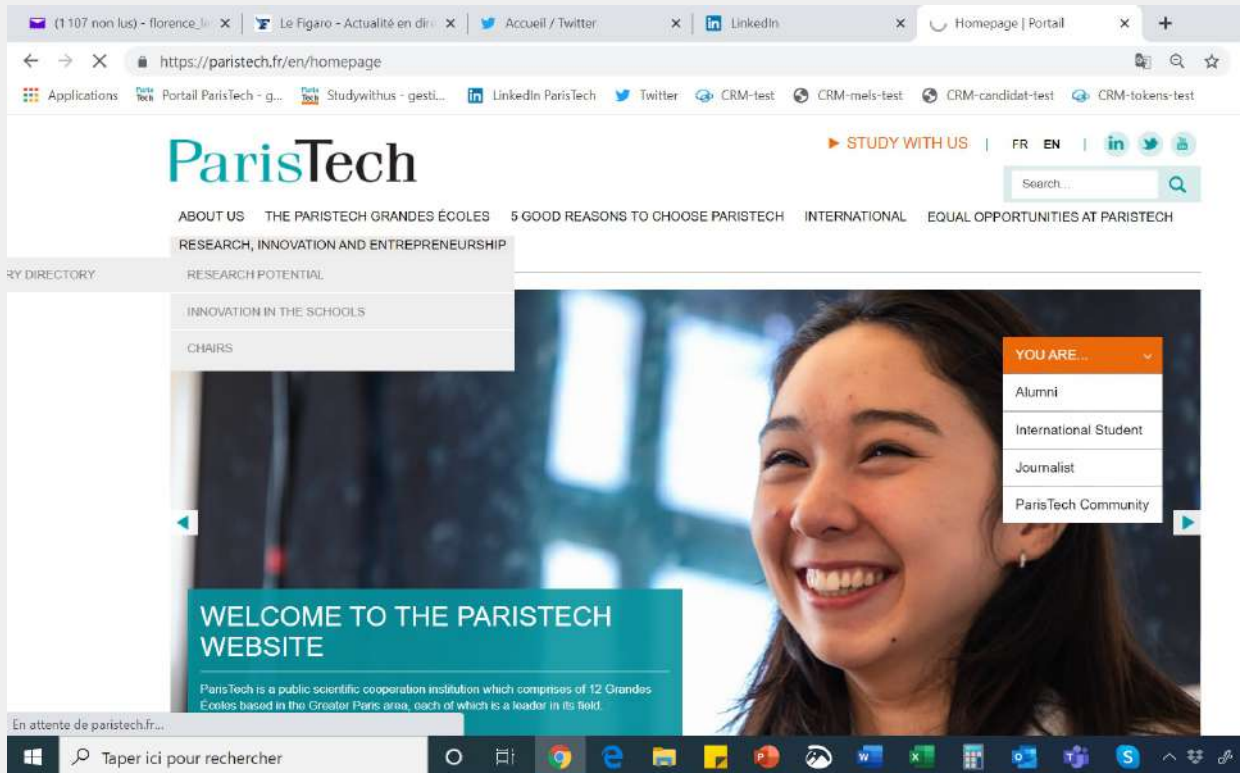

ABOUT US THE PARISTECH GRANDES ÉCOLES 5 GOOD REASONS TO CHOOSE PARISTECH INTERI

RESEARCH, INNOVATION AND ENTREPRENEURSHIP

Research, innovation and entrepreneurship > Research potential > Laboratory directory

### LABORATORY DIRECTORY

This directory lists the laboratories, classified by ParisTech *Grandes Écoles*, with a link to each school's website. The directory also lists the name of the laboratory's Director.

Note: This directory is built based on information from the *Grandes Écoles'* websites.

The terminology can vary from one *Grande École* to another. Thus one can talk of mixed research unit (partners) or laboratories.

Some *Grandes Écoles* federate their laboratories as part of a department. They are listed individually in the directory.

CHOOSE A RESEARCH DOMAIN :

 **LABORATORY AGROPARISTECH** +

 **LABORATORY ARTS ET MÉTIERS** +

# 2022-2023 Campaign

**6** SCHOOLS

**95** PHD PROPOSALS

**11** *in* FIELDS OF ENGINEERING

**+11** CITIES IN FRANCE



You can check them on the excel table, or download them all here:

<https://www.paristech.fr/en/international/china/paristech-csc/how-apply>

1/ Eligibility



2/ Funding scheme



3/ Calendar for the 2021/2022 campaign



4/ List of PhD proposals



You can download here the [2022 PhD proposals booklet](#) and the [Excel table](#), with subject listed according to the Research Fields covered by ParisTech.

Candidates can either apply to:

- **specific PhD research proposals (up to 3),**
- **and / or an entire research field:** in this case we strongly encourage you to check the [database of ParisTech publications](#) to identify potential PhD supervisors and mention them in your application.

Please note that you are encouraged to contact supervisors during the application process, either:

- **to make sure the research proposal corresponds to your project,**
- **or in the case you found a lab or supervisor you were interested in pursuing a PhD with, to define a thesis subject with them.**



# Where to get relevant information?

## PARISTECH SOCIAL MEDIA ACCOUNTS

*For videos, information on research and innovation in ParisTech schools...*

A  
C  
C  
O  
U  
N  
T  
S  
  
G  
L  
O  
B  
A  
L

[LinkedIn](#)



Instagram

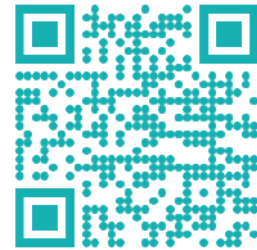

Twitter



Facebook



YouTube



A  
C  
C  
O  
U  
N  
T  
S  
  
C  
H  
I  
N  
E  
S  
E

[LinkedIn](#)



Wechat



Twitter



Weibo



Bilibili



# International admission process

**17 October 2022: Publication of the PhD proposals**

**October 17, 2022 – December 11, 2022 (23.59 Paris Time) : Application**

**December 23, 2022: Invitation to the interview**

**January 09 – 20, 2023: Interview with ParisTech**

**Late January – February 2023: Interview with the PhD supervisor(s)**

**Conditional Admission letter**

**March 2023: CSC scholarship application**

# Application

**Step 1- Publication of the PhD proposals on [ParisTech website](#) on October 17, 2022**

**Step 2- Online application from October 17 to December 11 (23:59 Paris Time), 2022**

## DOCUMENTS TO BE UPLOADED (\*ARE MANDATORY)

2 recommendation forms*	Student ranking certificates (at bachelor and master level)*
Academic transcripts (at bachelor and master level)*	English certificate (IELTS, TOEFL, CET-6/4, etc.)*
A personal statement including motivation and rough research plan (1-2 pages)*	A scan of your passport or resident ID card*
An ID photo*	An English summary of your master thesis
French certificate	Any further document proving your academic or scientific achievement / excellence (ex. university prize, published work, previously awarded scholarship)

**Step 4- Selection based on the application files and if selected, invitation to an interview (December 23, 2022)**

**Step 5- Online interviews from January 09 to 20, 2023**

**Step 6- Interview with the potential PhD supervisor(s) from end of January to end of February 2023**

**Step 7- Conditional admission letter provided to the selected applicants by the PhD supervisors (conditions: obtention of master degree and CSC scholarship) (before March 2023)**

**Step 8- Application for the CSC scholarship by the student (March 2023)**

**Step 9- Results of the CSC process (May-June 2023)**

*ParisTech China will ensure a follow-up process of the CSC scholars til the arrival in France, in relation with the ParisTech schools.*

# How will your application be evaluated?

## **In your application file**

- **The file you submit should be complete**
- Excellence of academic transcripts
- Ranking: personal ranking and ranking of your university at national and international level
- Referrals

## **During the interview**

- Your capacity to communicate in English, and even in French if you are able to
- Your capacity to present and explain clearly your personal and professional project

## **During the interview with the potential PhD supervisor**

- The relevance of your profile with the lab's requirements and the thesis
- Your scientific level in relevant fields

# Tuition Fees

***The doctoral training program total cost in France is between 100k & 150k Euros per year.***

***PhD candidates are only asked for tuition fees:***

Admitted students may benefit from a partial or full tuition fee waiver for the duration of their studies at their host ParisTech Grande École.

ParisTech Schools	Tuition fees
AgroParisTech	380€ + 92€ CVEC* each year
Arts et Métiers Sciences et Technologies	
Chimie ParisTech - PSL	
Ecole des Ponts ParisTech	
ESPCI Paris - PSL	
Institut d'Optique Graduate School	
MINES ParisTech - PSL	

# Results

By the end of May 2023 – June 2023, the CSC will announce the list of successful candidates.

*Each year, over 100 candidates apply to this program, half get a proposal from a ParisTech school lab.  
In 2020, 33 scholarships were granted by the CSC.*

Successful applicants will then receive their official admission letters, and be informed by the CSC about all the administrative procedures to follow before departure for France.

Once all administrative procedures over, and their visas obtained, PhD candidates will be expected to arrive in France in September – October 2023.

# Studying at Paristech:

## INTERNATIONAL STUDENTS SERVICES

- Accommodations
  - Help to find accommodation
  - Possibility of accommodation allowance
  - Average living costs in Paris:  
~ 800 € /month
- Assistance with visa procedure



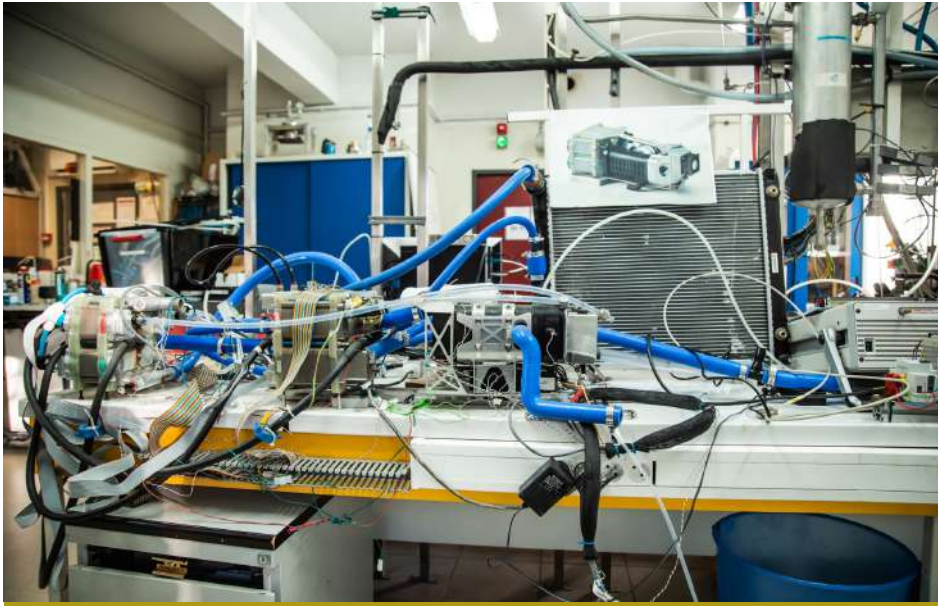

### 3. Research in ParisTech's Higher Education Institutions



# Excellence in Research

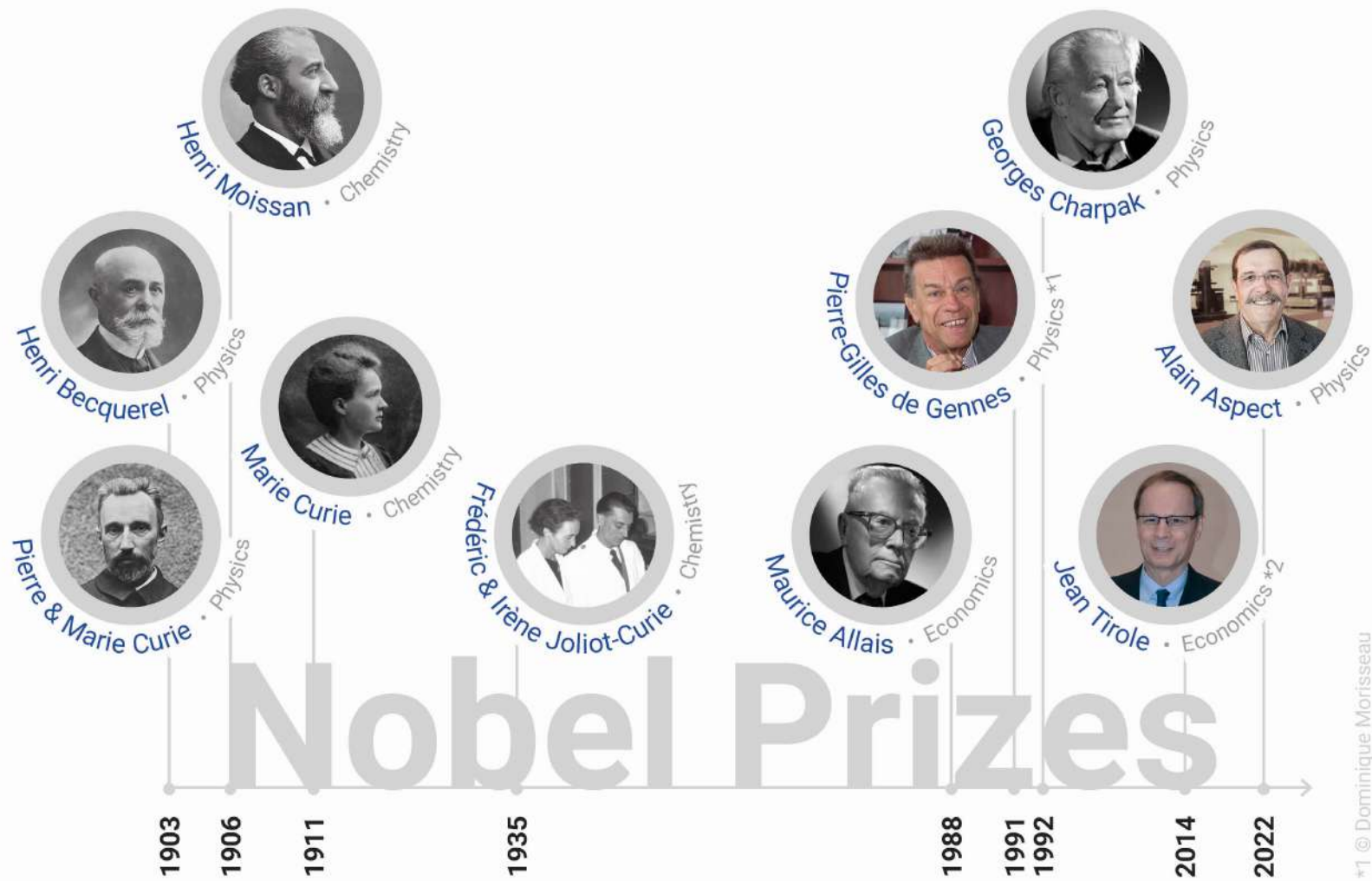

# Nobel Prizes

\*1 © Dominique Morisseau  
 \*2 © P. Renault/École des Ponts ParisTech

# RANKINGS



From 2020, in the international rankings



are ranked on their own



Shanghai Ranking (ARWU) 2022  
 University Paris-Saclay: **16<sup>th</sup>** (1st ) University PSL: **40<sup>th</sup>** (2<sup>nd</sup> )

**THE 2023**  
 PSL: **47<sup>th</sup>**  
 University UPSaclay: **93<sup>th</sup>**  
 Ecole des Ponts ParisTech: 251–300

**QS 2023**  
 PSL: **26<sup>th</sup>**  
 University UPSaclay: **69<sup>th</sup>**  
 Ecole des Ponts ParisTech: 174<sup>th</sup>

## Shanghai Ranking (ARWU) 2022 – by subject

<b>Physics</b> #9 UPSaclay #10 PSL	<b>Mathematics</b> #1 UPSaclay #12 PSL	<b>Chemistry</b> #51-75 UPSaclay #101-150 PSL
<b>Earth sciences</b> #41 PSL #48 UPSaclay #151-200 Ecole des Ponts PT	<b>Atmospheric science</b> #76-100 Ecole des Ponts PT	<b>Chemical Eng.</b> #301-400 PSL #301-400 UPSaclay
<b>Civil Eng.</b> #201-300 Ecole des Ponts PT	<b>Environmental Sc. &amp; Eng.</b> #151-200 UPSaclay #301-400 Ecole des Ponts PT	<b>Ecology</b> #5 PSL #76-100 UPSaclay
<b>Materials Sc. &amp; Eng.</b> #101-150 PSL	<b>Nanoscience &amp; Nanotechnology</b> #101-150 UPSaclay #151-200 PSL	<b>Energy Sc &amp; Eng</b> #201-300 PSL
<b>Mechanical Eng.</b> #76-100 PSL #151-200 A&M S&T	<b>Electrical and Electronic eng.</b> # 51-75 UPSaclay	<b>Water resources</b> #101-150 UPSaclay #151-200 PSL
<b>Automation &amp; Control</b> #101-150 PSL	<b>Metallurgical Eng.</b> #37 PSL #101-150 A&M S&T	<b>Medical Technology</b> #151-200 PSL
<b>Food S&amp;T</b> #76-100 UPSaclay	<b>Biotechnology</b> #30 UPSaclay #51-75 PSL	<b>Remote sensing</b> #76-100 UPSaclay
<b>Economics</b> #51-75 PSL #101-150 UPSaclay #301-400 Ponts PT	<b>Agricultural Sc.</b> #11 UPSaclay	<b>Biological sciences</b> #76-100 UPSaclay #101-150 PSL
<b>Human Biological Sciences</b> #76-100 UPSaclay	<b>Veterinary Sciences</b> #51-75 UPSaclay	

# Partner national research institutes



Géosciences pour une Terre durable

**brgm**

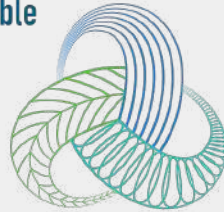

**IFSTTAR**



**ParisTech**

*Inria*



**INRAE**



# Research Domains

# Research Domains

- Chemistry, physico-chemistry, mechanical engineering
- Design, industrialization
- Economics, management and social sciences
- Energy, process
- Environmental S&T, sustainable development, geosciences
- Information and communication S&T
- Life and health S&T
- Life science and engineering for agriculture, food and environment
- Mathematics and applications
- Material sciences, mechanics and fluids
- Physics, optics
- Urban planning, transport

# ParisTech's Labs

Learn more about [the labs](#) in each school:

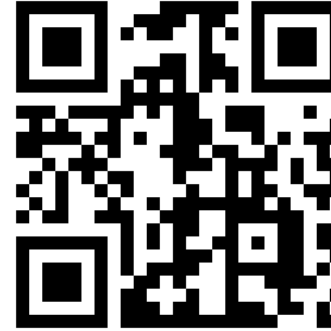

A screenshot of the ParisTech website's Laboratory Directory page. The browser address bar shows 'https://paristech.fr/en/node/45'. The page features the ParisTech logo, navigation links like 'STUDY WITH US', 'FR EN', and social media icons. A search bar is present. The main content area is titled 'LABORATORY DIRECTORY' and includes a brief description of the directory. Below this is a dropdown menu labeled 'CHOOSE A RESEARCH DOMAIN :' with 'All' selected. Two laboratory entries are visible: 'LABORATORY AGROPARISTECH' with the AgroparisTech logo and 'LABORATORY ARTS ET MÉTIERS' with the Arts et Métiers logo. On the right side, there are two teal buttons: 'SIGN UP FOR OUR NEWSLETTER!' and 'FIND OUR LATEST NEWSLETTER'.



# **RESEARCH AT CHIMIE PARISTECH - PSL**

**ILARIA CIOFINI**





ParisTech



# PARISTECH – CSC PHD PROGRAM



**19** PhD proposals

**3** Fields of research

**2** Labs



## Laboratories

I-CLeHS

IPVF

IRCP

## Research domains

The I-CLeHS laboratory, composed of 4 research teams, focuses on **Chemistry for Health and Life Sciences** with research spanning from fundamental to applied in theoretical and physical chemistry to organic and bio-inorganic chemistry

IPVF focuses on energy production (**photovoltaics**)

The 8 teams of the IRCP laboratory cover a wide variety of domains of chemistry going from **material science** to **energy production and storage**.

## RESEARCH INFRASTRUCTURES IN PARIS CITY CENTER



NMR/Mass/HPC facilities



Characterization (spectroscopy, microscopy)

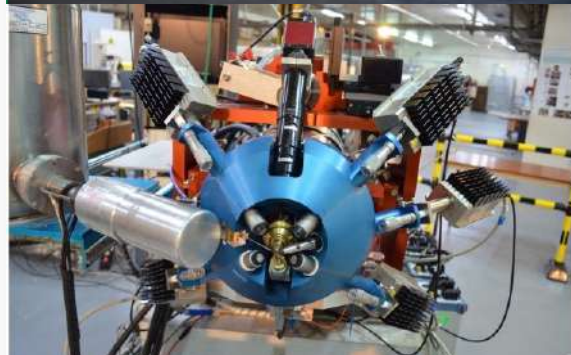

New Aglae (Louvre)



Chemistry



Optics

## KEY FACTS / FIGURES



140 researchers & teacher-researchers  
100 PhD candidates 50 % of international PhD candidates



Industrial Chairs  
Prestigious partnerships with academic laboratories & industrial partners  
Co-directed thesis with international partners (Italy, Mexico, South Africa...)



300 publication a year

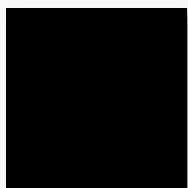

7 patents a year



and many others...

5 ERC (1 Starting, 2 Consolidator, 2 Advanced)

2 ITN (European Training Networks)

1 IUF (Senior)

1 CNRS Silver Medal

Several international prizes ( France-Berkeley Funds Award, Swiss National Science Foundation .... )





**RESEARCH AT  
ARTS ET MÉTIERS  
INSTITUTE OF TECHNOLOGY**

**ALI SIADAT**



# ARTS ET MÉTIERS INSTITUTE OF TECHNOLOGY



*Shaping tomorrow's technology*



# RESEARCH AND INNOVATION

---

# ARTS ET MÉTIERS IN NUMBERS



1780

Founded by the Duke  
Of Rochefoucault-Liancourt

**11**



**SITES**

located all over France  
dedicated to Teaching &  
Research

**270**



**PHD STUDENTS**

at our Doctoral School  
"Sciences des Métiers  
de l'Ingénieur"

**1**



**BACHELOR  
OF TECHNOLOGY**

**6254**



**STUDENTS**

all programs included

**15**



**LABORATORIES**

and research teams

**11**



**ENGINEERING PROGRAMS**

1 broad-based 10 specialized

**1011**



**PERSONNEL**

Teachers, Technicians &  
Administrative Staff

**7 MILLIONS**



income

**+20**



**RESEARCH MASTERS**

**15 MILLIONS** €

income generated  
by industry contracts

**2000**



**CONTINUING EDUCATION**

auditors

**17**



**EXECUTIVE MASTER  
PROGRAMS**



# 5 STRATEGIC INDUSTRIAL FIELDS TO MEET FRENCH AND INTERNATIONAL INDUSTRIAL EXPECTATIONS

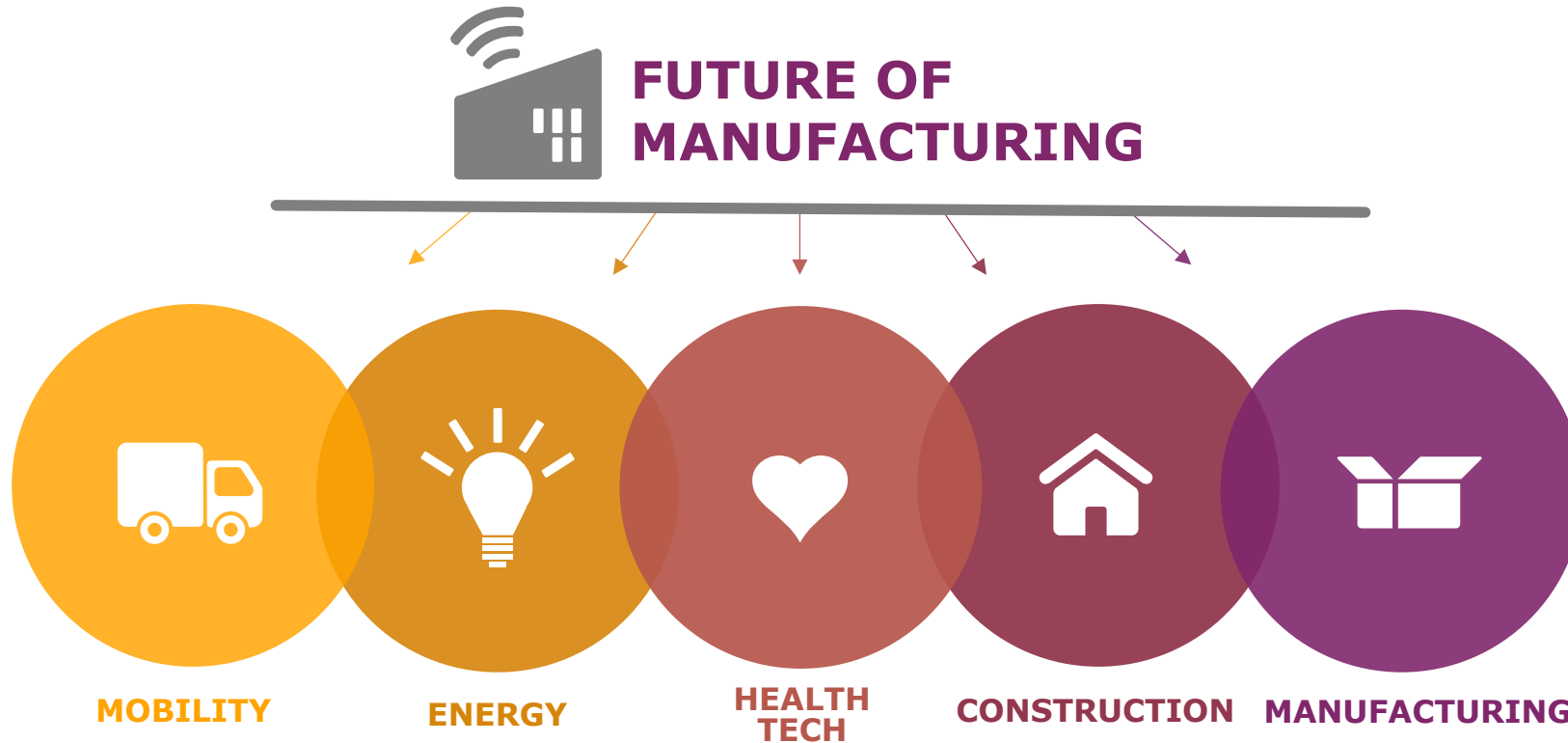

# OUR SPECIALTY: RESEARCH ON THE **FULL PRODUCT LIFE CYCLE**

→ FROM DESIGN TO RECYCLING, THROUGH EVERY INTERMEDIATE STAGE

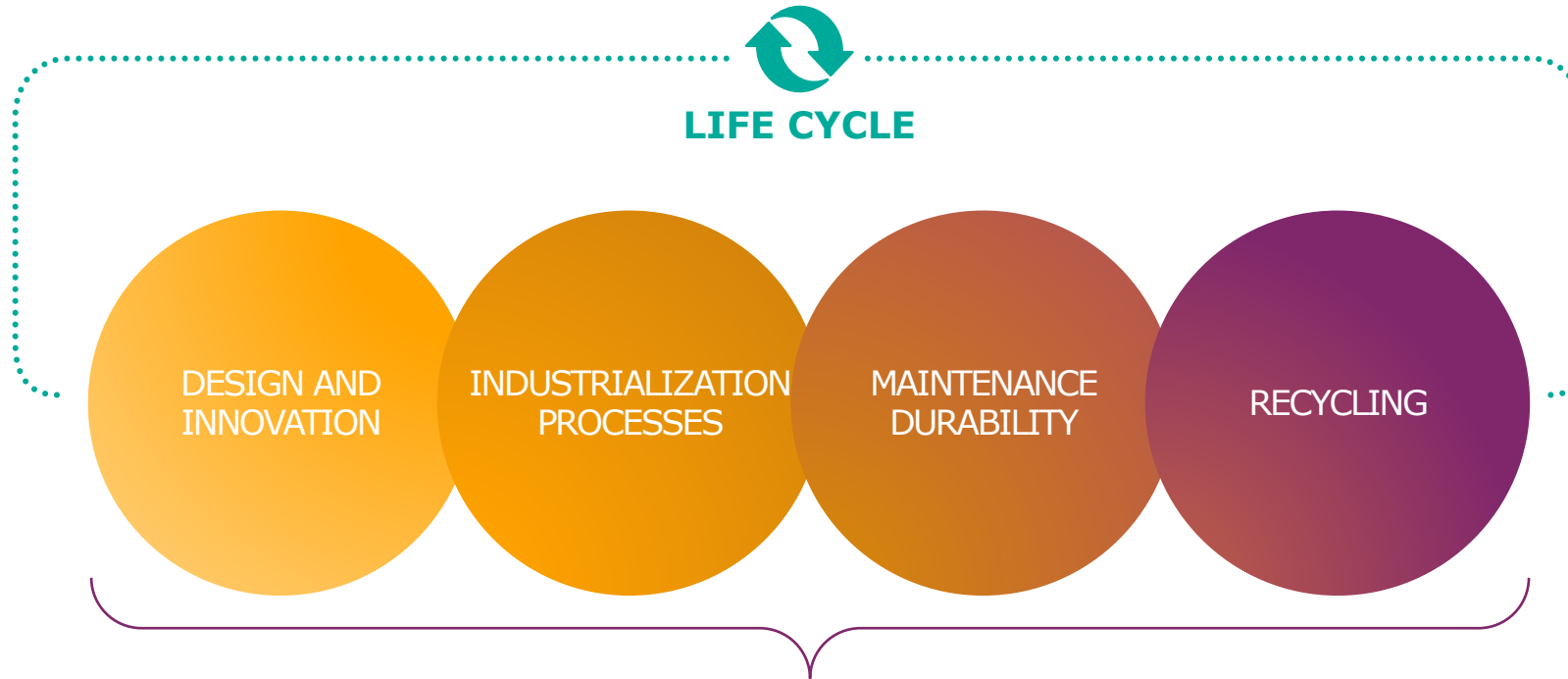

- ▶ Environmental and societal impact approach
- ▶ Development of groundbreaking digital tools with real world applications

## 3 TASKFORCES: LIFECYCLE DIGITALIZATION

### Taskforce 1: Lifecycle digitization (CDIO)

- 1.1 Data: measurements, collection, treatment, including data reduction
- 1.2 Data-improved physical models
- 1.3 Human machine interface, VR/AR
- 1.4 Digital twin/product lifecycle management/digital model: Lifecycle digitalization (CDIO)

## 3 TASKFORCES: SMART MATERIALS, STRUCTURES AND SYSTEMS

### **Taskforce 2: Smart materials, structures and systems**

Advances in IoT tools, modelling and real-time control offer new opportunities to increase self-control/self-repair/self-diagnosis capacity on all system levels. Digital, electronic, and sensors technologies contribute to the development of new materials/structures/systems.

#### **Targeted application domains:**

- 2.1: Robotics and cobotics
- 2.2: Smart materials
- 2.3: Smart process control
- 2.4: Smart systems

## 3 TASKFORCES: SUSTAINABLE ENGINEERING AT LOW CARBON IMPACT

### **Taskforce 3: Eco-engineering and carbon impact management**

- 3.1 Lifecycle analysis
- 3.2 Eco innovation/design
- 3.3 Energy management of systems and industry
- 3.4 Convergence of digital and carbon impact (link to Taskforce 1)

# ARTS ET MÉTIERS RESEARCH IS CONDUCTED IN 19 DIFFERENT DOMAINS

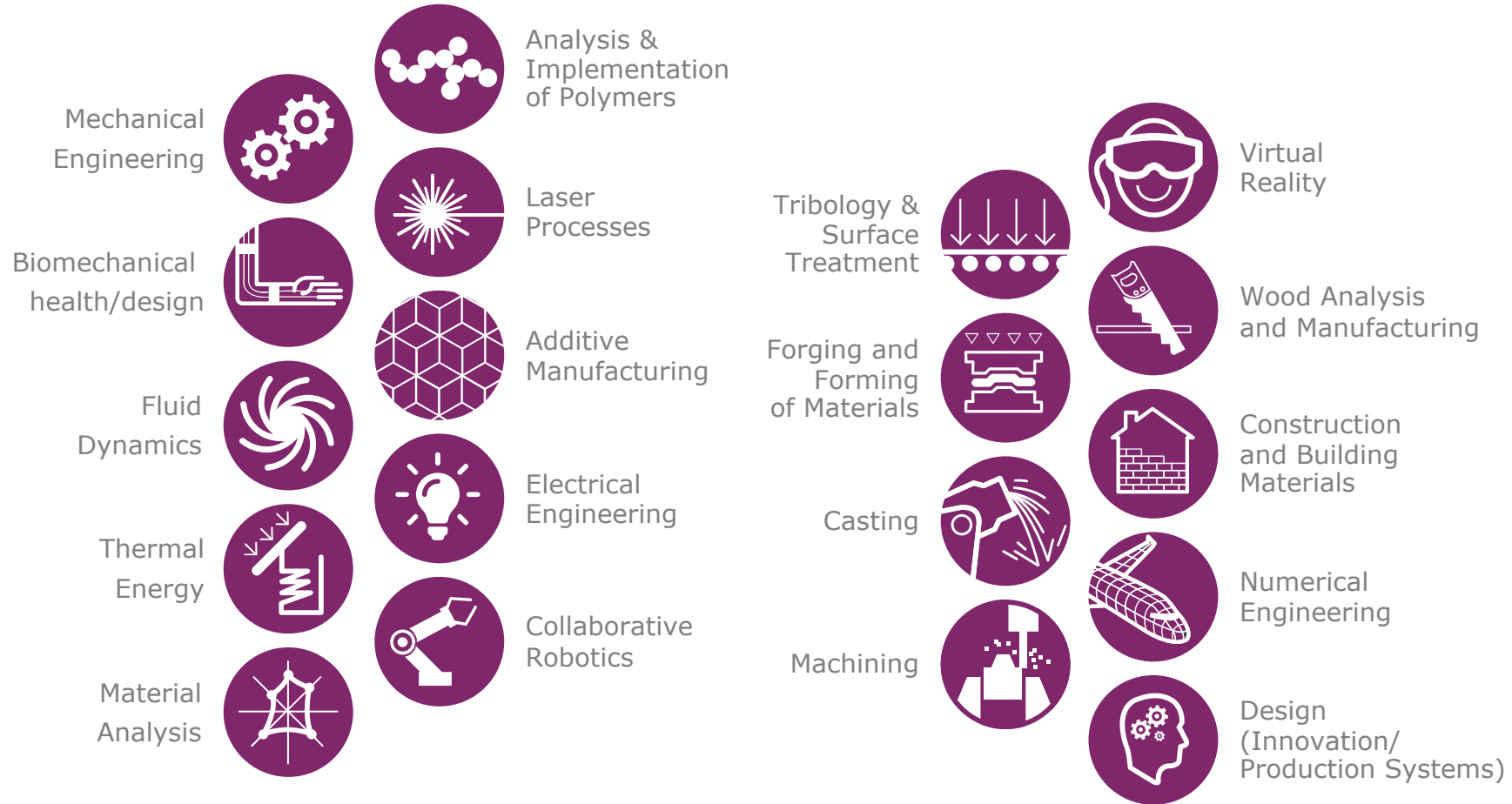

# 1 INSTITUTION WITH 8 CAMPUSES AND 3 SATELLITE LOCATIONS 15 LABORATORIES CLOSE TO LOCAL ECONOMIC PLAYERS

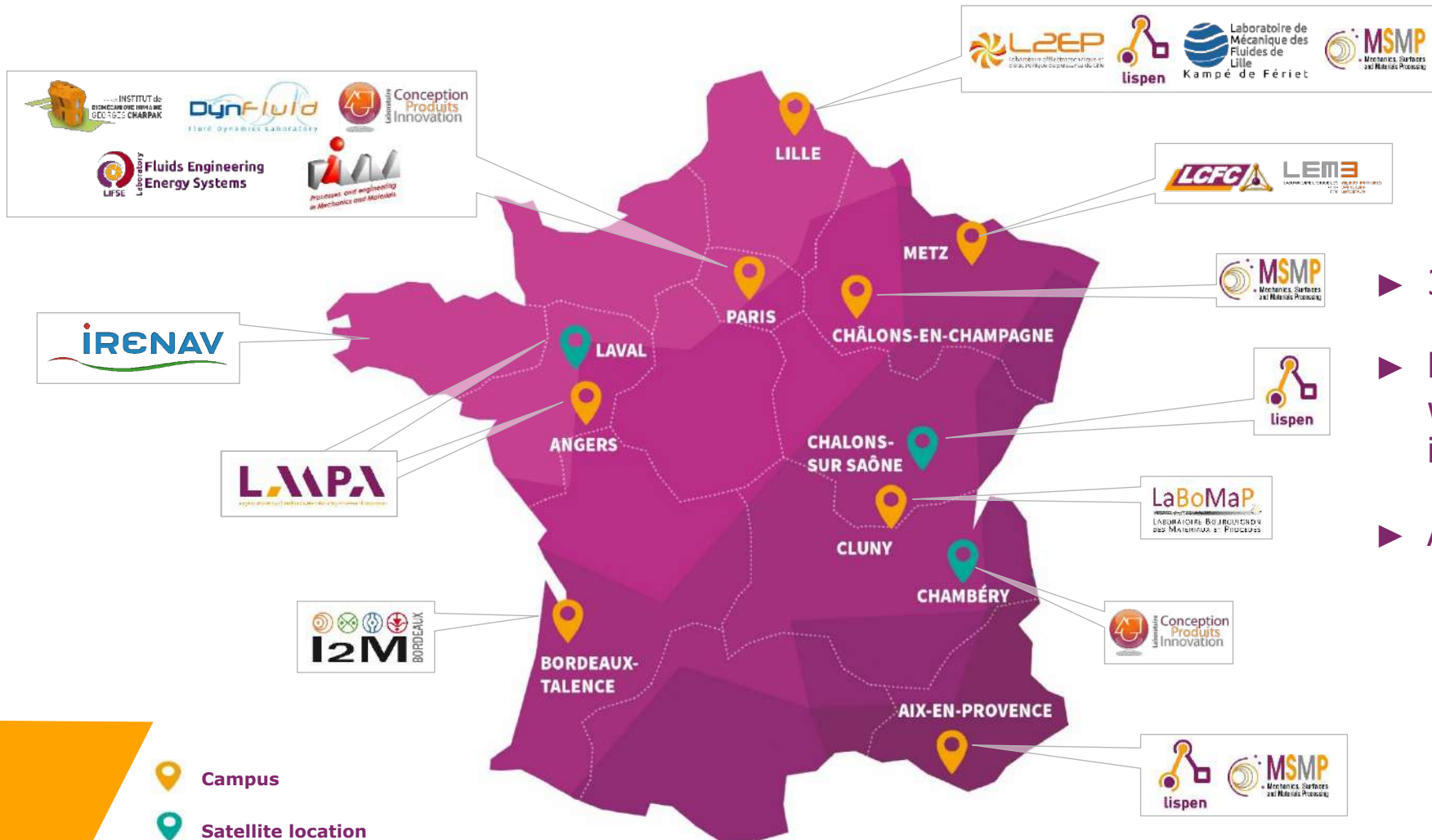

- ▶ 350 researchers
- ▶ Enhanced by our partnerships with local universities and institutions
- ▶ A strong national presence

# DIFFERENT AREAS OF EXPERTISE PER SITE

## Lille

Fluid Mechanics, Electrical Engineering, Collaborative Robotics, Tribology & Surface Treatment

## Paris

Mechanical Design, Design (including Innovation), Biomechanics/Health, Fluid Mechanics, Thermal Energy, Materials Analysis, Testing & Implementation of polymers, Laser Processes, Additive Manufacturing

## Laval

Virtual and augmented Reality,

## Angers

Mechanical Studies, Machining Assistance, Virtual Reality, Fluid Mechanics

## Bordeaux-Talence

Mechanical Studies, Design, Thermal Energetic, Additive Manufacturing, Sustainable Engineering

## Châlons-en-Champagne

Mechanical Studies, Tribology & Surface Treatment, Casting

## Metz

Mechanical Design, Design (Production of Systems), Materials Analysis, Forge & Forming of Materials

## Cluny

Machining/Assistance, Wood, Construction & Materials for Construction, Surface Treatment

## Chalon-sur-Saône

Virtual Reality

## Chambéry

Environmental Innovation, Eco-design, Recycling

## Aix-en-Provence

Design (of production systems), Numerical engineering, Tribology & Surface Treatment, Casting

 Campus

 Satellite location







# INTERNATIONAL STRATEGIC PARTNERSHIPS

---

AM<sup>2</sup>

TRANSATLANTIC PARTNERSHIP WITH TEXAS A&M



Contact

Mohamed El Mansori

Mohamed.ElMansori@ensam.eu

Partnership with **Texas A&M**, College of Engineering and TEES in the USA, founded in 2017 after 20+ yrs. of collaboration

Collaboration in the area of **advanced manufacturing and material science:**

- ▶ Extensive research collaborations
- ▶ Education programs (student exchanges, internships, and collaborative degrees)
- ▶ Mutual faculty and faculty exchanges
- ▶ Consortium plan with key industrial partners aims to address the key industry challenges in the emerging industry 4.0



[Website](#)



# FRENCH-GERMAN INSTITUTE FOR INDUSTRY OF THE FUTURE

## EUROPEAN PARTNERSHIP WITH KIT



Contact

Jean-Yves Dantan

Jean-Yves.Dantan@ensam.eu

Partnership with **Karlsruhe Institute of Technology** in Germany, founded in 2016, after 20+ yrs. of collaboration.

4 research axes, all based on a human-centered approach:

- ▶ Advanced Manufacturing Processes
- ▶ Production Systems
- ▶ Virtual & Augmented Reality
- ▶ Robotics

Collaboration in:

- ▶ Research (collaborative grant submissions and projects)
- ▶ Education (exchanges, joint PhD doctoral school, dual Eng and MA double degree program)
- ▶ Innovation



[Website](#)



# DESCARTES: A CREATE PROGRAM ON INTELLIGENT MODELLING FOR **DECISION-MAKING** IN **CRITICAL URBAN SYSTEMS**



Since: 2021

Grant: 35M

Host institution:



160 researchers

Director: F. Chinesta  
Francisco.CHINESTA@ensam.eu

**DesCartes**  
a new **Hybrid paradigm** for AI,  
combining human and machine reasoning  
to control critical infrastructures in a smart  
city, at the intersection of engineering,  
knowledge and society

**DesCartes**  
More than an AI program:  
a **crossdisciplinary framework**

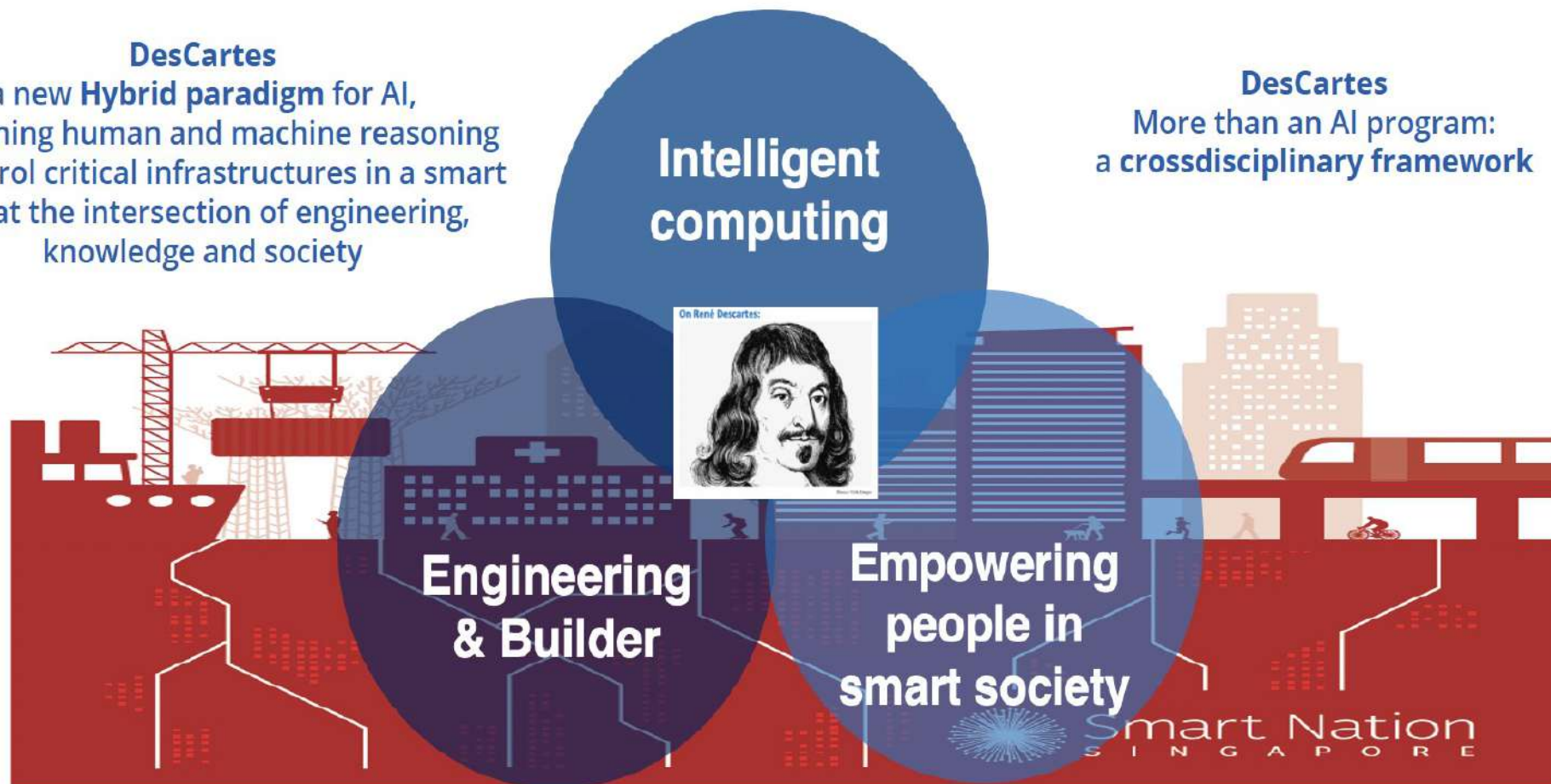

# DESCARTES: A CREATE PROGRAM ON INTELLIGENT MODELLING FOR **DECISION-MAKING** IN **CRITICAL URBAN SYSTEMS**



**DESCARTES IS A CROSS DISCIPLINARY PROGRAM INVOLVING STEM AND NON-STEM RESEARCH WITH ARTIFICIAL INTELLIGENCE AT ITS CORE AND EXPERTISES IN:**

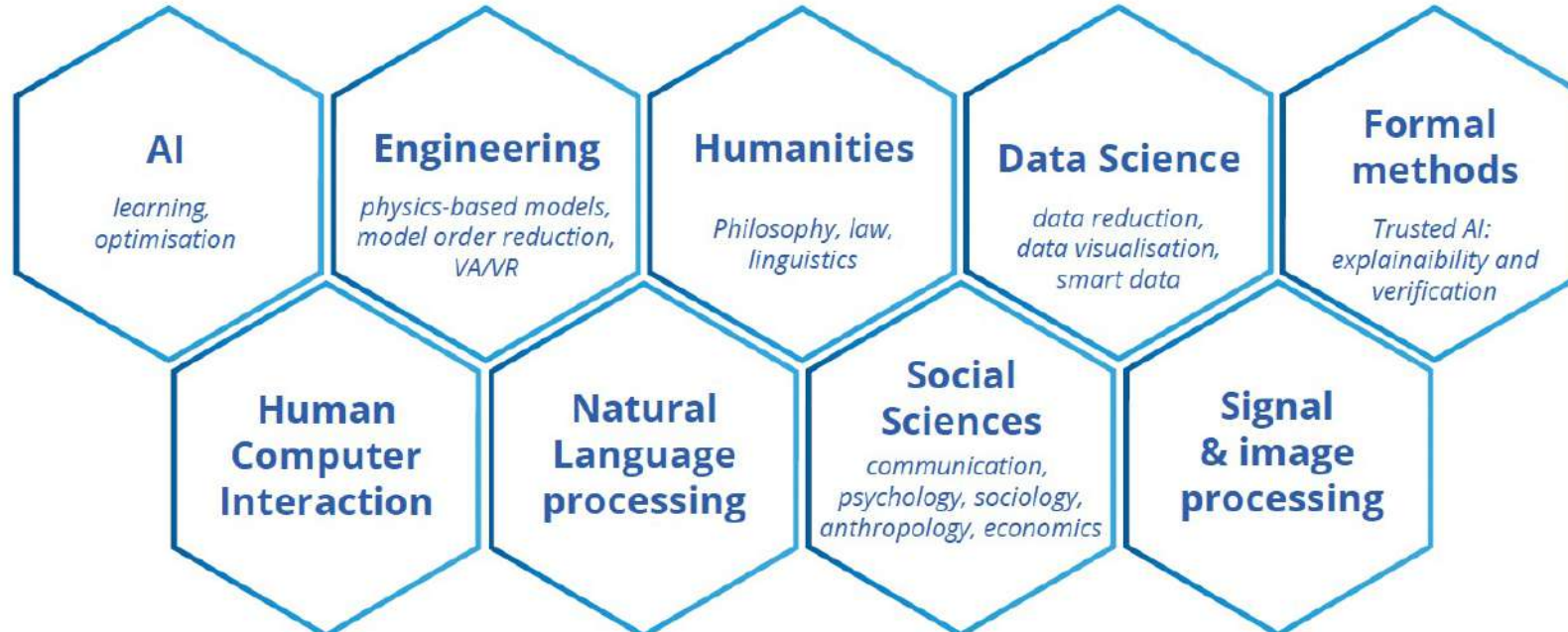



# **RESEARCH AT MINES PARIS - PSL**

**ALEXANDRA BELUS**



ParisTech



# PARISTECH – CSC PHD PROGRAM



**2** PhD proposals

**3** Fields of research

**2** Labs



Centre  
de Recherche  
en Informatique

**CENTRE FOR ROBOTICS**

- ▶ Founded in 1783 to train engineers, now a **graduate school in Science, Engineering and Economics**
- ▶ **Founding member of ParisTech & PSL – Université Paris Sciences et Lettres**
- ▶ **Founding and prime member of Institut Carnot M.I.N.E.S.**
- ▶ **Member of IMT – Institut Mines Télécom**
- ▶ **5 sites:** Paris, Evry, Fontainebleau, Palaiseau and Sophia Antipolis
- ▶ ~240 professors, ~1000 students, ~400 PhD candidates
- ▶ **17 research centres & 2 institutes within 5 departments**
- ▶ **More than 50% of graduated PhD work in industry**
- ▶ **2022 Launching of the Transition Institute 1.5 (TTI.5) – pluri disciplinary institute for low carbon transition**





## Research domains at MINES ParisTech – PSL:

### Energy and process engineering

- Centre for Energy Efficiency of Systems ([CES](#))
- Centre Thermodynamics of Processes ([CTP](#))
- Centre Observation, Impacts, Energy ([O.I.E.](#))
- Centre for Processes, Renewable Energies and Energy Systems ([PERSEE](#))

### Earth sciences and environment

- Centre for Geosciences ([GEOSCIENCES](#))
- Higher Institute for Environmental Engineering and Management ([ISIGE](#))

### Mathematics and complex systems

- Centre of robotics ([CAOR](#))
- Centre for bio-informatics ([CBIO](#))
- Centre Automatic Control and Systems ([CAS](#))
- Centre of Applied Mathematics ([CMA](#))
- Centre of Mathemacial Morphology ([CMM](#))
- Centre of Computer Sciences ([CRI](#))

### Materials and mechanics

- Centre of Material Transformation ([CEMEF](#))
- Centre of Material Engineering ([MAT](#))

### Economy, management and society

- Centre for Industrial Economics ([CERNA](#))
- Centre for Management Science ([CGS](#))
- Research Center on Risks and Crisis ([CRC](#))
- Centre for the Sociology of Innovation ([CSI](#))

## IHEIE

Institute of Higher Education for  
Innovation and Entrepreneurship

## RESEARCHER AT MINES PARISTECH – PSL RECENT AWARD / GRANT RECIPIENTS

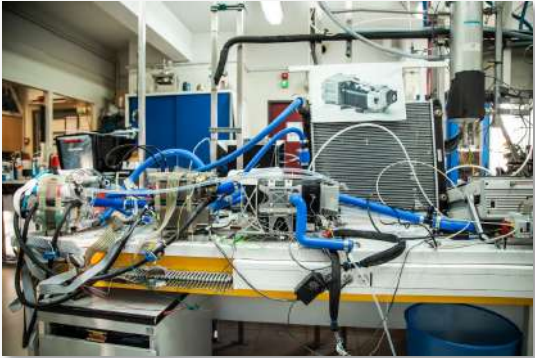

ELIE HACHEM- CEMEF  
ERC CONSOLIDATOR GRANT 2022



TATIANA BUDTOVA - CEMEF  
CNRS SILVER MEDAL 2020



Name

Name



PIERRE ROUCHON - CAS  
ERC ADVANCED GRANT 2020



ZAKI LEGHTAS - CAS  
ERC STARTING GRANT 2019

## KEY FACTS / FIGURES



~100 PhDs awarded annually (25 % of women, 30 % of foreigners (~50 nationalities), 50 % engineers)  
232 teaching researchers (15% recruited abroad)



400+ scientific publications rank A / year



300+ patents & softwares in 2019



### 2 Nobel prizes

Maurice ALLAIS - Economics - 1988  
Georges CHARPAK – Physics – 1992  
3 ERC in the past 4 years



Prestigious partnerships with academic laboratories, companies:

20 % of research contracts completed with international partners.  
Partnerships with: MIT, CalTech, Jülich, CERN, Stanford

25 industrial chairs / 200 industrial partners  
MINES ParisTech ranks number one in France for the volume of contractual research with companies.  
1000 /year Research contracts – 30 M





# **RESEARCH AT INSTITUT D'OPTIQUE GRADUATE SCHOOL**

**DENIS BOIRON**

Education



Research

Innovation

# Institut d'Optique – 3 locations

Paris Saclay

Campus Paris Saclay  
FONDATION DE COOPERATION SCIENTIFIQUE



Labo C. Fabry

503 INSTITUT  
d'OPTIQUE  
GRADUATE SCHOOL  
CENTRE ENTREPRENEURIAL

Bordeaux

université  
de BORDEAUX



Labo LP2N

Espace  
503



St Etienne



Labo H. Curien



## RESEARCHERS AT INSTITUT D'OPTIQUE GRADUATE SCHOOL



**ALAIN ASPECT**

**Holweck Medal (1991)  
Wolf Prize in Physics (2010)  
Albert Einstein Medal (2012)  
ForMemRS (2015)**



**PHILIPPE GRANGIER**

**Léon Brillouin Grand Prix (2013)  
Jean-Ricard Prize (2008)  
Lazare Carnot Prize (2005)  
CNRS Silver medal (2002)**



**JEAN-JACQUES GREFFET**

**OSA fellow  
Recipient of the Servant  
prize of the French  
Academy of Science**



**Laurent COGNET**

**Jean Jerphagnon Prize (2010)  
Pierre Faurre Prize (2011)  
ERC synergy awardee (2020)**

**Start up: Muquans, Pasqal, Stereolabs, Damae Medical ...**



## RESEARCHERS AT INSTITUT D'OPTIQUE GRADUATE SCHOOL



ALAIN ASPECT

Holweck Medal (1997)  
Wolf Prize in Physics (2002)  
Albert Einstein Medal (2005)  
ForMemRS (2015)

Alain Aspect: **Nobel laureate 2022 in physics**

**“For experiments with entangled photons,  
establishing the violation of Bell inequalities and  
pioneering quantum information science”**

**Start up:** Muquans, Pasqal, Stereolabs, Damae Medical ...



## LP2N

*Photonics, Numerical and Nanosciences  
Laboratory (LP2N) is a Joint Research Unit (UMR  
5298) between the Institut d'Optique Graduate  
School, the University of Bordeaux and the CNRS.*

**20 researchers**

**30 PhD/Post-doc**

Light in Complex Nanostructures (COS) group

"Cold Atoms in Bordeaux" (CAB) group

BioImaging & OptoFluidics group

Nano-BioMicroscopy team (NabLab)

Computational Imaging and Display

Photonics systems





**LCF**  
*Laboratoire Charles Fabry*

**40 researchers**  
**60 PhD/Post-doc**



Quantum Gases group

Quantum Optics group

Laser group

Nanophotonics group

Biophotonics group

Imaging & Information group

Nonlinear optics group

XUV optics group



Micro & nano structuring group

Materials for optics and photonics in  
extreme environments group

Laser-matter interaction group

Image science & computer vision group

Secure embedded systems & hardware  
architecture group

LHC

*Laboratoire Hubert Curien*

**90 researchers**

**110 PhD/Post-doc**



Data intelligence group



# **RESEARCH AT ÉCOLE DES PONTS PARISTECH**

**YU JUN CUI**

# Research domains at Ecole des Ponts ParisTech



## Industry of the future

- NAVIER** – ecomaterials, digital manufacturing, innovative structures, geomechanics
- CERMICS** – modelisation of uncertainty, digital simulation, systems optimisation
- LIGM** – data processing, 3D vision, big data

## City and mobility systems

- LVMT** – sustainable mobility, territorial dynamics
- LEESU** – urban waters, alternative resources
- CEREA** – atmospheric environment, air quality, renewable energy

## Management of risks, resources and milieus

- HM&Co** – hydro-meteorological risks, resilient cities
- LMD** – physics of atmosphere, climate
- LHSV** – renewable energy, natural risks

## Economy, practices and society

- LATTS** – cities of future, infrastructures, policies
- PjSE** – public policies, environmental economy, markets and governance
- CIREDD** – sustainable development, climate change

# RESEARCH INFRASTRUCTURES



École des Ponts  
ParisTech



Fresnel



Build'In



X- band radar



Platform  
TARANIS



Blue-Green  
Wave



Multi-Hydro,  
RadX@HMo



EDF'lab Chatou

# RESEARCH AT ECOLE DES PONTS PARISTECH : KEY FACTS/FIGURES



École des Ponts  
ParisTech



465 researchers / teacher-researchers  
540 PhD and post doctoral students including  
46 % of international doctoral students



51% of research sponsored by industry



968 international publications in 2020  
including 47% international co-publications



... and much more



10 M€ contracts with companies



3 ERC, a lot of PhD prizes, 1 For Women in  
science L'Oréal-UNESCO Young researcher  
etc.



# **RESEARCH AT ESPCI PARIS - PSL**

**JOSHUA MCGRAW  
XIAOPING JIA  
COSTANTINO CRETON**



ParisTech



# PARISTECH – CSC PHD PROGRAM

ESPCI  PARIS | PSL 

**16** PhD proposals

**5** Fields of research

**6** Labs

**LPem**

**C** CHIMIE  
**B** BIOLOGIE  
**I** INNOVATION

**G** UMR 7083  
**river**

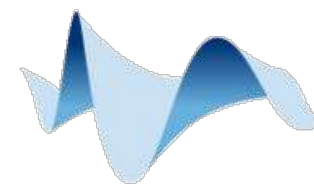

**Institut Langevin**  
ONDES ET IMAGES

Physique et Mécanique  
des Milieux Hétérogènes  
UMR 7636



**Plasticité du Cerveau**



Research @ESPCI Paris

20播放 · 0弹幕 2020-10-30 17:56:29



1人正在看, 0条弹幕



A 发个友善的弹幕见证当下

弹幕礼仪 >

发送

Find the video on ParisTech China Bilibili account!



Research domains at ESPCI Paris – PSL:

Biology

- **Brain Plasticity Lab** – neurosciences + proteomics
- **Physics for Medicine** – wave physics for medicine

Chemistry

- **Chemistry of Molecules and Materials** – chemistry of molecules and materials
- **Soft Matter Science and Engineering, Institute of Porous Materials (IPM)** – Soft Matter, Materials Science & Complex Fluids
- **CBI** – microfluidics for physical chemistry and pharmaceuticals

Physics

- **Institut Langevin, Physics for Medicine** – wave physics and applications
- **Physics & Materials Lab** – solid state physics, nanosciences
- **PMMH** – hydrodynamics and solid mechanics
- **Gulliver** – Soft Matter Physics

RESEARCH INFRASTRUCTURES

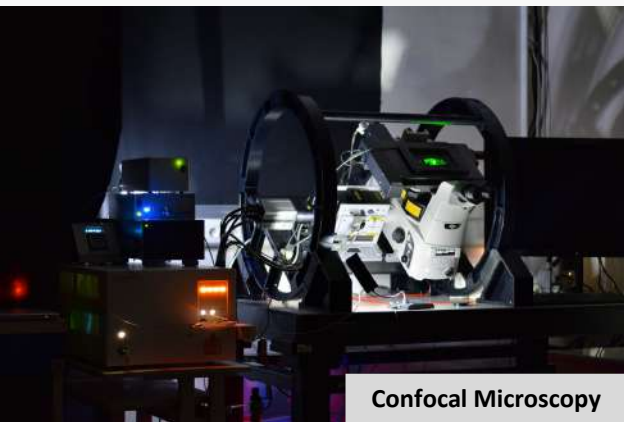

Confocal Microscopy



3D Printing



Microfluidic

SOME KEY RESEARCHERS  
ESPCI PARIS - PSL



MATHIAS FINK  
ULTRASOUNDS (ERC)



MICKAEL TANTER  
IMAGERY FOR  
MEDICINE (ERC)



CHRISTIAN SERRE  
METAL ORGANIC  
FRAMEWORKS



ANKE LINDNER  
COMPLEX FLUIDS  
CNRS SILVER MEDAL



ANDREW GRIFFITHS  
MICROFLUIDICS FOR  
PHARMA (ERC)



SANDRINE ITHURRIA  
QUANTUM DOTS (ERC)

## KEY FACTS / FIGURES



ca. 500 researchers / teacher-researchers  
ca. 300 PhD candidates



Prestigious partnerships with academic laboratories and companies



About 500 publications per year including 10-15% in journals with impact factor > 10



30 patents per year  
3 startups created each year



6 Nobel Prizes, 17 ERC grants, CNRS Silver Medals, UNESCO-L'Oréal For Women in Science awardees Young Researchers



©F. Lelait



©Antoine Mercier

# Information & Contact

# ParisTech Office in Asia



## Contacts in China:

Marie de BONI  
Director of ParisTech in Asia  
[marie.deboni@paristech.fr](mailto:marie.deboni@paristech.fr)

YANG Minhua  
Program Officer  
[minhua.yang@paristech.fr](mailto:minhua.yang@paristech.fr)  
Tel: +86 21 65 98 23 36

WECHAT



WEIBO



BILIBILI





©AgroParisTech

## 4. Labs and PhD proposals



©Institut d'Optique, F. Balembois

## ROOMS / THEMES

ROOM 1

→ Chemistry, Physical chemistry and Chemical Engineering + Life and Health science

ROOM 2

→ Information and Communication Science and Technology + Mathematics and their applications + Energy, Processes + Design, Industrialization

ROOM 3

→ Material science, Mechanics and Fluids

ROOM 4

→ Physics, Optics





ParisTech



## **6. LABS AND PHD PROPOSALS**

**ROOM 1 / CHEMISTRY, PHYSICAL CHEMISTRY AND  
CHEMICAL ENGINEERING + LIFE AND HEALTH SCIENCE**

# ROOM1 - Chemistry, Physical chemistry and Chemical Engineering + Life and Health science - PROPOSALS/LABS 1/2

File Number	School	Title	Advisors	Lab
2022_001	Chimie ParisTech - PSL	Synthesis of Organometallic Complexes of Medicinal Relevance	Gilles Gasser, Kevin Cariou	I-CLEHS - Institute of chemistry for life and health
2022_002	Chimie ParisTech - PSL	Electrochemical Activation of Ynamides	Kevin Cariou, Gilles Gasser	I-CLEHS - Institute of chemistry for life and health
2022_006	Chimie ParisTech - PSL	Modeling the electronic and optical properties of van der Waals heterostructures	FREDERIC LABAT	I-CLEHS - Institute of chemistry for life and health
2022_049	Chimie ParisTech - PSL	In-silico design and optimization of molecular systems for Aggregation-Induced Emission (AIE)	Ilaria Ciofini, Carlo Adamo	I-CLEHS - Institute of chemistry for life and health
2022_050	Chimie ParisTech - PSL	Construction of Chiral Diphosphines through Rh(III)-catalyzed Atroposelective C-H Bond Functionalization and Use thereof in Asymmetric Catalysis	Jean-François Soulé, Phannarath Phansavath , Virginie Vidal	I-CLEHS - Institute of chemistry for life and health
2022_052	Chimie ParisTech - PSL	Mechanochemistry-Assisted Continuous Synthesis of Organometallic Complexes of Medicinal Relevance	CHRISTOPHE LEN, KEVIN CARIOU, GILLES GASSER	I-CLEHS - Institute of chemistry for life and health
2022_069	Chimie ParisTech - PSL	Instrumental and methodological developments for the on-line coupling of microfluidic capillary electrophoresis to surface enhanced Raman spectroscopy (MCE-SERS) applied to the separation and identification of submicro- and nanoplastics in water	Anne Varenne, Fanny d'Orlyé, Laura Trapiella Alfonso	I-CLEHS - Institute of chemistry for life and health
2022_074	Chimie ParisTech - PSL	Radical arylations for the production of active pharmaceutical ingredients in batch and flow mechanochemistry	CHRISTOPHE LEN	I-CLEHS - Institute of chemistry for life and health

# ROOM1 - Chemistry, Physical chemistry and Chemical Engineering + Life and Health science - PROPOSALS/LABS 2/2

File Number	School	Title	Advisors	Lab
2022_060	ESPCI Paris - PSL	Self-Assembled Molecular Layers for Perovskite Solar Cells	Zhuoying CHEN, Philippe Lang, Laurent Billot	LPEM - Laboratoire Physique et d'études des matériaux
2022_062	Chimie ParisTech - PSL	Enhanced Passivity and Corrosion Resistance of Multi Principal Element Alloys	Dimitri Mercier	IRCP - Institut de Recherche de Chimie de Paris
2022_064	Chimie ParisTech - PSL	Novel green organic inhibitors for the corrosion protection of metals and alloys	Dimitri Mercier, Dominique Costa	IRCP - Institut de Recherche de Chimie de Paris
2022_063	ESPCI Paris - PSL	The Glass Transition Challenge Tackled with Nano-Colloids	Paddy Royall	GULLIVER - Voyages expérimentaux et théoriques en matière molle
2022_008	Chimie ParisTech - PSL	Synthesis and Formulation of Biodegradable Polymers from Renewable Resources	Kawthar BOUCHEMAL, Christophe THOMAS	IRCP - Institut de Recherche de Chimie de Paris
2022_009	Chimie ParisTech - PSL	Smart Material Design for Vectorization of Biocompatible and Biodegradable Polymer-Coated Nanoparticles	Régis GAUVIN, Christophe THOMAS	IRCP - Institut de Recherche de Chimie de Paris
2022_010	Chimie ParisTech - PSL	Production of Sustainable Polymers by One-Pot Catalysis	Christophe THOMAS, Régis GAUVIN	IRCP - Institut de Recherche de Chimie de Paris
2022_012	Chimie ParisTech - PSL	Oxide-based crystals doped by Pr <sup>3+</sup> , Dy <sup>3+</sup> or Tb <sup>3+</sup> for solid-state visible laser : crystal growth and optical spectroscopic properties	AKA Gerard, LOISEAU Pascal	IRCP - Institut de Recherche de Chimie de Paris
2022_055	Chimie ParisTech - PSL	Chemical Bonding of Graphene on TiO <sub>2</sub> for Boosted Interfacial Charge Transfer in Optoelectronic Devices	Thierry Pauporté	IRCP - Institut de Recherche de Chimie de Paris
2022_096	Chimie ParisTech - PSL	Molten Salt Conversion of Plastics into Hydrogen	Virginie LAIR, Vincent SEMETEY	IRCP - Institut de Recherche de Chimie de Paris
2022_097	Chimie ParisTech - PSL	3D two-photon polymerization of smart materials	Vincent SEMETEY	IRCP - Institut de Recherche de Chimie de Paris
2022_091	ESPCI Paris - PSL	Investigating the role of LRRK2 in the gut-brain axis in Parkinson's disease using Drosophila	Serge Birman	Plasticité du cerveau

# ParisTech

#Connect

#Innovate

#Share

[www.paristech.fr](http://www.paristech.fr)



Catalysis, Synthesis of Biomolecules  
and Sustainable  
Development Team (CSB2D)

#homogeneous catalysis;  
#enantioselectivity



Pr. J.-F. Soulé



Dr. P. Phansavath



Dr. V. Vidal

Project N°  
2022\_050

Construction of Chiral Diphosphines through Rh(III)-catalyzed Atroposelective  
C–H Bond Functionalization and Use thereof in Asymmetric Catalysis

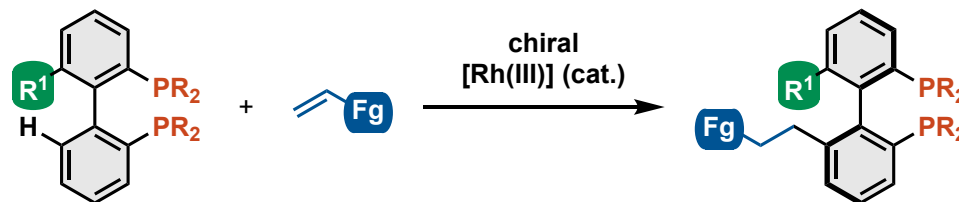

**PROBLEMATIC:** How to induce rollover C–H bond cleavage and to control the way (left or right)

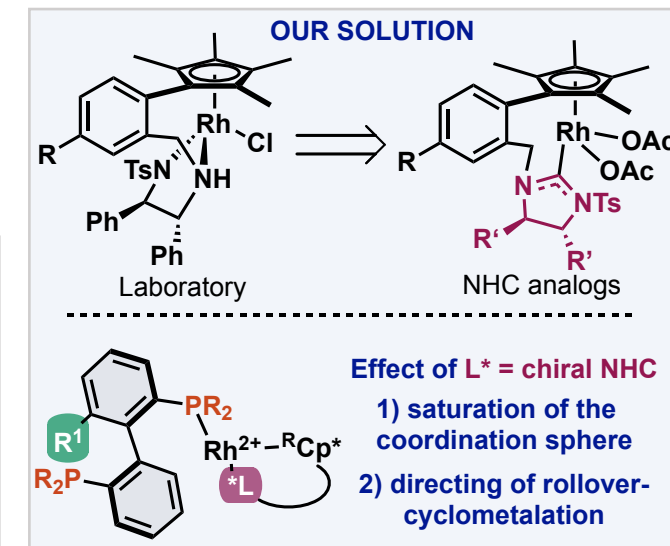
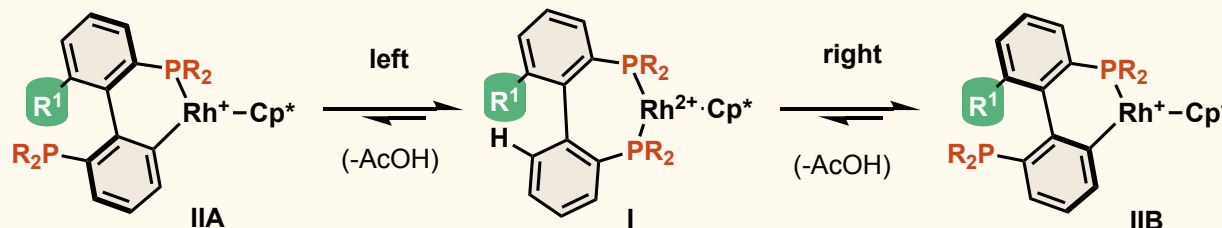

# ParisTech

#Connect

#Innovate

#Share

[www.paristech.fr](http://www.paristech.fr)



## KEY THEMATICS

Synthesis of functionalized (bio)molecules using microwaves, plasma gas & continuous flow in liquid milli- and micro-reactors

Analytical electrochemistry, biosensors

Synthesis and physico-chemical characterization of nanoplatforms for  
theranostic

Lab-on-a-chip ( $\mu$ TAS)

Imaging and diagnosis

Name

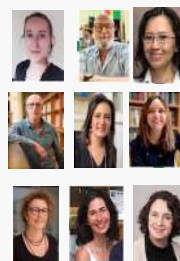

## PHD PROPOSALS (1)

### DESIGN OF NEW LAB-ON-A-CHIP DEVICE FOR SUBMICRO- AND NANOPLASTIC ANALYSIS

Instrumental and methodological developments for the on-line coupling of microfluidic capillary electrophoresis to surface enhanced Raman spectroscopy (MCE-SERS) applied to the separation and identification of submicro - and nanoplastics in water

A. Varenne,  
F. d'Orlyé, L. Trapiella

**Topic number : 2022\_069**



**DESIGN OF NEW LAB-ON-A-CHIP DEVICE FOR SUBMICRO- AND NANOPLASTIC ANALYSIS**

*Societal issues:*

- *Environmental fate*
- *Risk assesment for living organisms and human health*

→ Analytical and technological developments

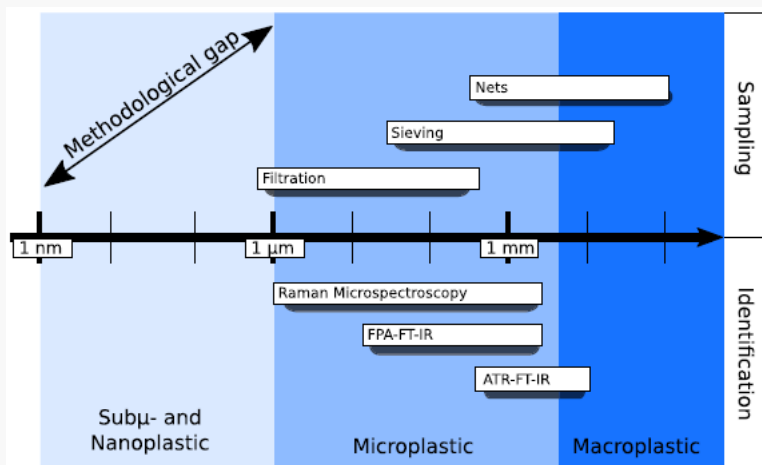

*The analysis of plastic particles is established for particles down to 1 mm.*

*Below, there is a methodological gap!*

Trends in Analytical Chemistry 112 (2019) 52-65





Physico-chemical characterization, identification and quantification of nanoplastics  
up to toxicity and biodistribution assessments

Main analytical and technological challenges:

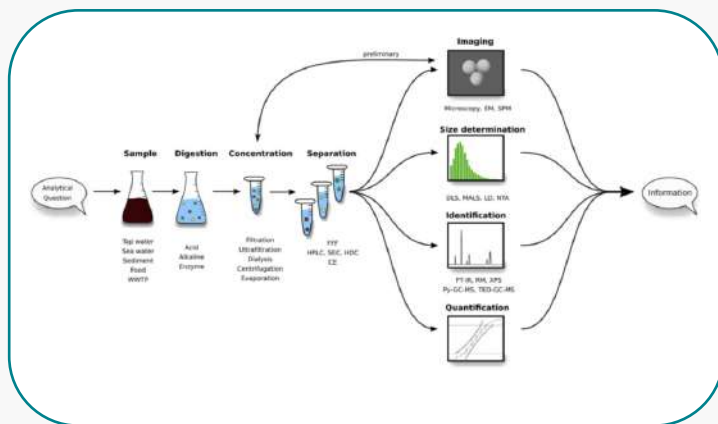

Trends in Analytical Chemistry 112 (2019) 52-65

- *Electrokinetic separations for nanoplastic*
  - preconcentration
  - separation into fractions of specific size and surface chemistry
  - evaluation of non specific interactions with plasmatic proteins
  
- *Surface Enhanced Raman Scattering (SERS) detection for nanoplastic*
  - label-free detection
  - structural description
  - sensitive and quantitative detection
  
- *Microfabrication and surface engineering processes for*
  - the miniaturization and integration of the SERS detection on a microelectrophoresis chip
  - the fully automated analysis of micro- and nanoplastic in water samples

# ParisTech

#Connect

#Innovate

#Share

[www.paristech.fr](http://www.paristech.fr)





LABORATOIRE DE PHYSIQUE ET D'ETUDE DES MATÉRIAUX  
(LPEM)

[HTTPS://WWW.LPEM.ESPCI.FR/SPIP.PHP?RUBRIQUE4](https://www.lpem.espci.fr/spip.php?rubrique4)



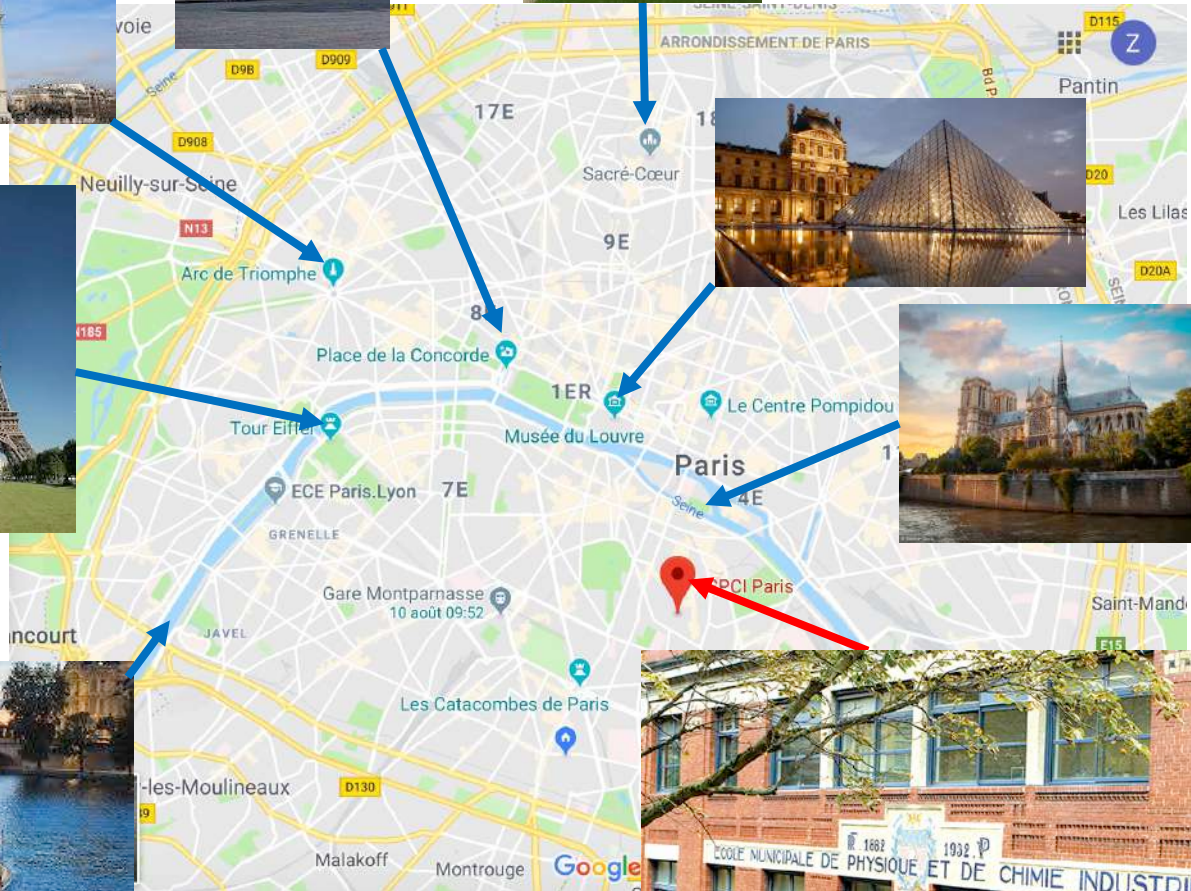

Located in the center of Paris

# Laboratoire de Physique et d'Etude des Matériaux (LPEM)



- **Nanophysics, Nanostructures and Nanomaterials,**
- **Strongly correlated and low dimensionality electronic systems,**
- **Technical instrumentales**

9 Research teams

About 34 permanants

About 35 PhD students, post-docs

**Conductivité Optique**

**Elemag**

**Instrumentation**

**MNC group**

**PHASME group**

**Quantum Matter Group**

**QuantumSpecs**

**Synthesis and Imaging of Inorganic Nanoprobes**

**Theory of Strongly Correlated Materials**

# Laboratoire de Physique et d'Etude des Matériaux (LPEM)



## KEY FACTS / FIGURES



30 researchers / teacher-researchers (10 % of international researchers / teacher-researchers)  
 23 doctoral students including > 50 % of international doctoral students



Prestigious partnerships



Cleanroom networks  
 "Paris Centre"

And many others !



Since 2004: 2 ERC Awards;  
 27+ ANR projects, 10 PHC projects, 4 H2020 awards...

### Laboratoire de Physique et d'Etude des Matériaux

Navigate by sections

#### 608 Productions with a French affiliation (since 2013)

scanR lists the publications with French affiliation, published since 2013, and having either a Crossref DOI, a HAL identifier or a sudoc identifier.

List Visualisation

Do you detect an error, an omission? Contribute!

Production type

Publications (516)

Select a period



Search in productions

Research fields Open Access Distribution by year Publications wordcloud Top 10 journals Publication types

Disclaimer: These data represent only what scanR managed to collect. They cannot be used for assessment purposes.

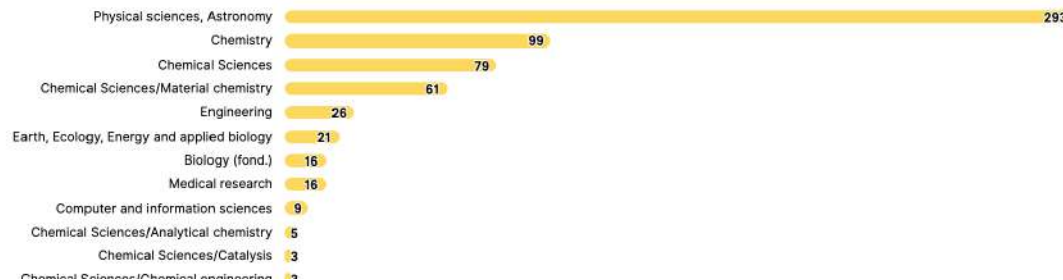

## 2023 CSC-ParisTech 4 proposals from LPEM

### Physics

**TITLE: HIGH TEMPERATURE SUPERCONDUCTORS FOR SINGLE PHOTON DETECTION**

**Topic number : 2022\_043**

**Field :** Physics, Optics, Material science, Mechanics and Fluids, Information and Communication Science and Technology

### Chemistry, engineering

**TITLE: SELF-ASSEMBLED MOLECULAR LAYERS FOR PEROVSKITE SOLAR CELLS**

**Topic number : 2022\_060**

**Field :** Chemistry, Physical chemistry and Chemical Engineering, Energy, Processes, Material science, Mechanics and Fluids

### Physics

**TITLE: ELECTRONIC STRUCTURE OF THE INTERCALATED GRAPHENE-Ge INTERFACES**

**Topic number : 2022\_051**

**Field :** Physics, Optics, Material science, Mechanics and Fluids,

**Subfield:** Surface Science,

### Physics

**TITLE: VO<sub>2</sub>-BASED PLASMONIC HYBRID NANOSTRUCTURES FOR TUNABLE OPTICAL SENSORS**

**Topic number : 2022\_081**

**Field :** Physics, Optics, Chemistry, Physical chemistry and Chemical Engineering,

# PhD thesis project no. 2022\_060: Self-assembled Molecular Layers for Perovskite Solar Cells

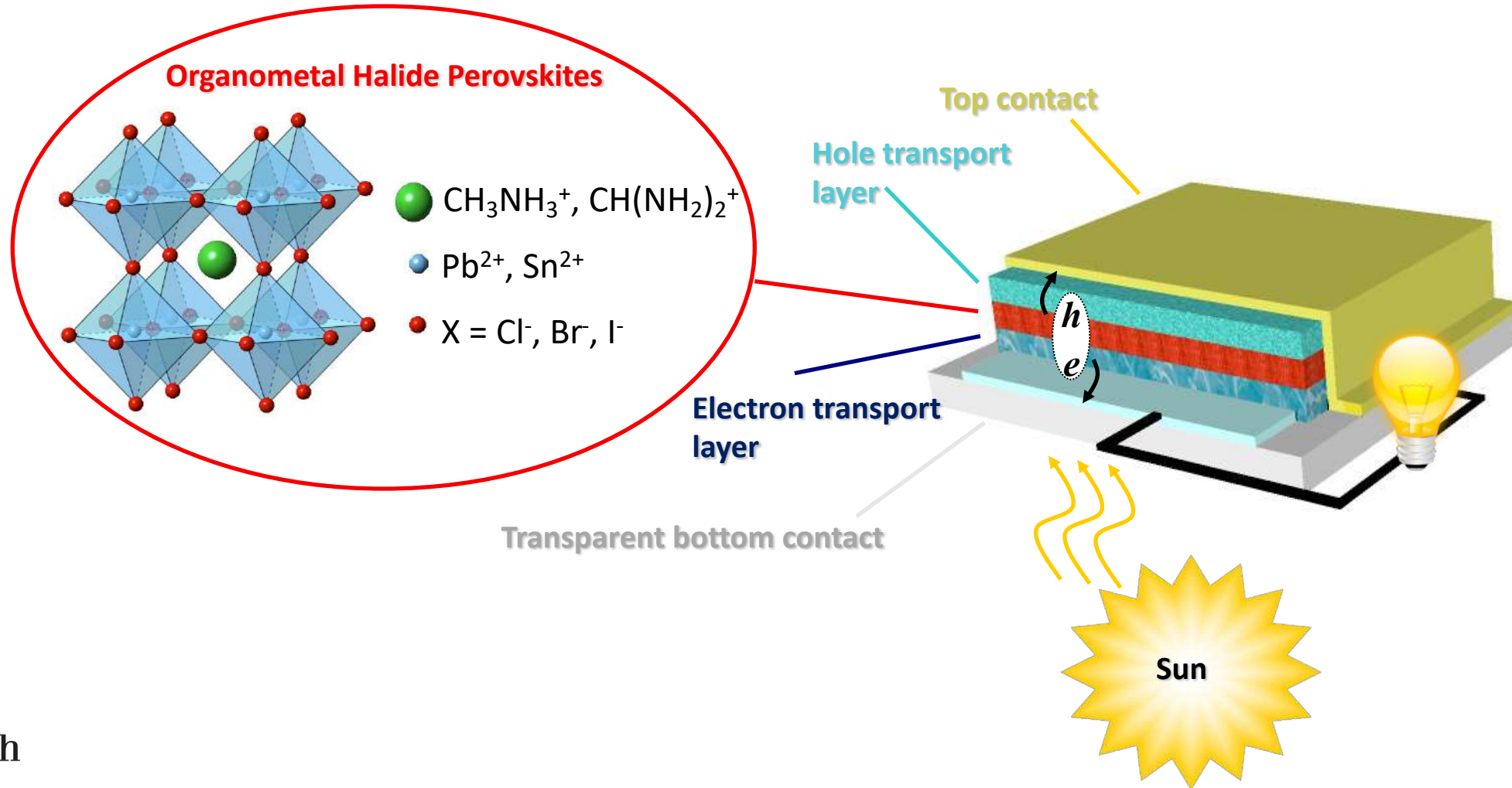



## no. 2022\_060: Self-assembled Molecular Layers for Perovskite Solar Cells

Problems: state-of-the-art e/h transport layer costly; requiring energy-demanding processing !

### Project :

$X' = -(CH_2)_n-Z ; n=0-2$   
 $X = -(CH_2)_m-Z ; m=0-2$   
Z group having affinity towards perovskite cristal

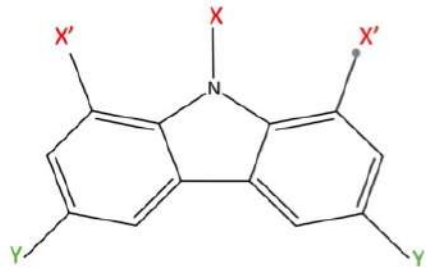

Y= attracting or donor group

ITODYS

Univ. Paris Cité

Top electrode  
Hole transport layer  
Perovskite absorber  
TiO<sub>2</sub> nanocolumns (NA)  
on compact TiO<sub>2</sub>  
FTO/glass

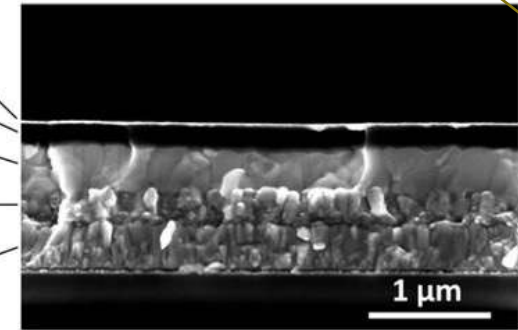

Zhuoying Chen



Laurent Billot



LPEM  
Laboratoire de Physique et d'Etude des Matériaux

Univ. PSL

- Design, synthesis of (self-assembled) molecular transport layers
- Device fabrication, transport and photovoltaic property evaluation

# ParisTech

#Connect

#Innovate

#Share

[www.paristech.fr](http://www.paristech.fr)



# ParisTech

#Connect #Innovate #Share



PCS / IRCP

**IR**  
**CP** | Institut  
de Recherche  
de Chimie Paris

Research domain(s): Surface Science applied to Corrosion protection

Research team (name) and its research axis  
(ex. Integrated product & process design)

Team leader



Philippe Marcus

P. Marcus  
(DRCE)

Understanding and control the relationships between the structure and chemical composition of metal and alloy surfaces and the properties of metal/gas and metal/liquid interfaces, from nanoscale to macroscopic properties, with applications in the fields of materials and energy.

**Surface atomic scale  
characterization**

**Modelling (oxidized) metal surfaces and  
interaction with the environment**

**Electrochemistry, passivation and  
corrosion resistance of metals and  
alloys**

**Biointerfaces**

## RESEARCH INFRASTRUCTURES

- X-Ray Photoelectron Spectroscopy (XPS)
- Time of Flight Secondary Ion Mass Spectroscopy (ToF-SIMS)
- Auger Electron Spectroscopy (AES)
- Low Energy Electron Diffraction (LEED)
- Scanning Tunneling Microscopy (UHV STM)
- Scanning Tunneling Spectroscopy (STS)
- Atomic Force Microscopy (AFM)
- Current Sensing Atomic Force Microscopy (CS-AFM)
- Electrochemical techniques : cyclic voltammetry, electrochemical impedance spectroscopy, photocurrent spectroscopy, electrochemical quartz crystal microbalance
- Electrochemical Scanning Tunneling Microscopy (EC-STM)
- Electrochemical Atomic Force Microscopy (EC-AFM)
- DFT calculations



## RESEARCHER (S)



P. Marcus  
(DRCE)



V. Maurice  
(DR2)



D. COSTA  
(DR2)



J. Swiatowska  
(DR2)



D. Mercier (CR)



S. ZANNA (IRHC)



A. Galtayries  
(MC)



F. Wiame  
(MC)



E. Protopopoff  
(MC)



A. Seyeux  
(IR2)



L. Klein  
(IR1)

## KEY FACTS / FIGURES



5 researchers / 3 teacher-researchers  
6 doctoral students, 100% of international  
doctoral students  
3 post-docs



### New International Award for Pr. Philippe Marcus

Pr. Philippe Marcus, Head of the Physical  
Chemistry of Surfaces Research Group at  
IRCP/Chimie ParisTech, elected member of the  
Academy of Europe (Academia Europaea).



More than 200 pubs.  
Many international co-publications



ERC Consolidated Grant CIMNAS

Need for environmental friendly Corrosion Inhibitors of Al alloys

Heterogeneous Surface

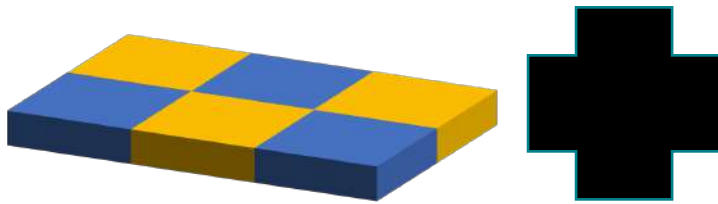

N-Heterocyclic Carbens

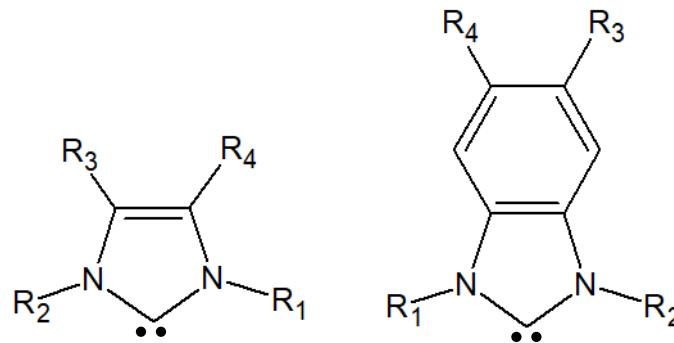

?

=

Universal protection

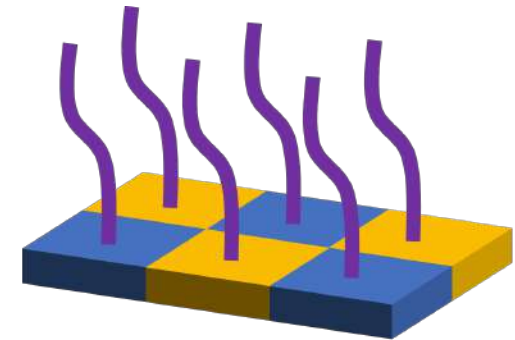

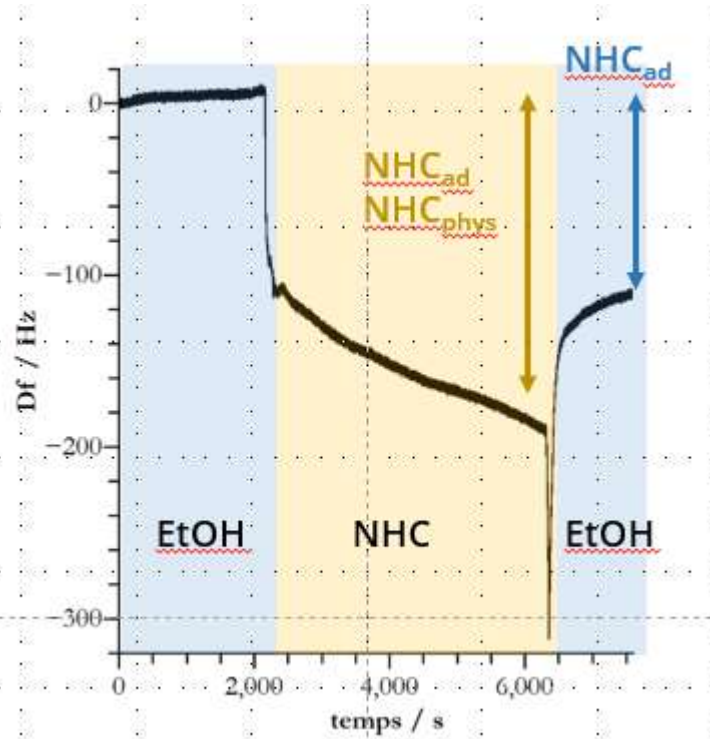

QCM: adsorption kinetics

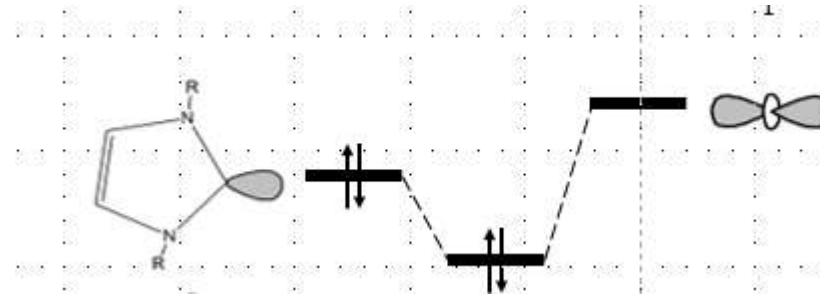

DFT: understanding of molecule/surface interactions

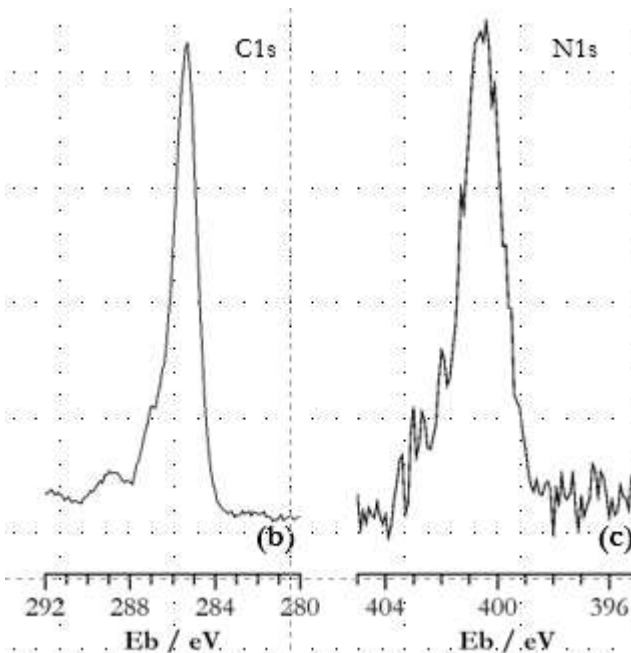

XPS molecule fingerprint:  
layer by layer characterization

Electrochemistry:  
corrosion inhibition ??



# ParisTech

#Connect

#Innovate

#Share

[www.paristech.fr](http://www.paristech.fr)





# ParisTech



## **6. LABS AND PHD PROPOSALS**

**ROOM 2 / INFORMATION AND COMMUNICATION SCIENCE  
AND TECHNOLOGY + MATHEMATICS AND THEIR  
APPLICATIONS + ENERGY, PROCESSES + DESIGN,  
INDUSTRIALIZATION**

# ROOM2 - Information and Communication Science and Technology + Mathematics and their applications + Energy, Processes + Design, Industrialization- PROPOSALS/LABS 1/2

File Number	School	Title	Advisors	Lab
2022_056	Arts et Métiers	Intelligent Haptics for the Perception of Fluid Properties	Samir GARBAYA, Sofiane KHELLADI	LIFSE - Laboratoire Ingénierie des Fluides Systèmes Energétiques
2022_018	Arts et Métiers	Optimization of an overspray system for turbomachines applications	Khelladi Sofiane, Capurso Tommaso	LIFSE - Laboratoire Ingénierie des Fluides Systèmes Energétiques
2022_047	Arts et Métiers	Experimental investigation of Cavitation vs. Degassing phenomena in a symmetrical Venturi channel	FLORENT RAVELET, AMELIE DANLOS, MICHAEL PEREIRA	LIFSE - Laboratoire Ingénierie des Fluides Systèmes Energétiques
2022_070	Arts et Métiers	Development of Data-Driven Physic-Guided Modelling Methodology For Hydrogen Energy Systems	Michaël DELIGANT	LIFSE - Laboratoire Ingénierie des Fluides Systèmes Energétiques
2022_036	Arts et Métiers	MOOC in Virtual Reality: learning through volumetric capture of lecture	Sylvain Fleury, Simon Richir	LAMPA - Laboratoire angevin de mécanique, procédés et innovation
2022_098	Arts et Métiers	Development of a digital twin of the Robotized Incremental Sheet Forming process using Virtual Reality	Philippe Dal Santo, Idriss Tiba, Sandra Chevret, Yessine Ayed	LAMPA - Laboratoire angevin de mécanique, procédés et innovation
2022_013	Arts et Métiers	Geometry processing for reducing cybersickness in VR	Ruding Lou, Frédéric Mérienne	LISPEN - Laboratoire d'ingénierie des systèmes physiques et numériques
2022_045	Arts et Métiers	Graph-based unbounded constrained models search for high-level logical reasoning	Mathias KLEINER, Jean-Philippe PERNOT	LISPEN - Laboratoire d'ingénierie des systèmes physiques et numériques
2022_058	Arts et Métiers	Reinforcement learning-based 3D reconstruction of CAD models from dead models for smart manufacturing applications	Jean-Philippe PERNOT, Arnaud POLETTE	LISPEN - Laboratoire d'ingénierie des systèmes physiques et numériques
2022_059	Arts et Métiers	Topology-preserving non-rigid deformation of CAD models from point clouds for first-time-right production in smart manufacturing	Jean-Philippe PERNOT, Arnaud POLETTE	LISPEN - Laboratoire d'ingénierie des systèmes physiques et numériques
2022_065	Arts et Métiers	A decision aid system based on a decentralized architecture to faster the management of hazards occurring under production and logistics systems	Lionel Roucoules, Esma YAHIA, Nathalie Klement	LISPEN - Laboratoire d'ingénierie des systèmes physiques et numériques
2022_099	Arts et Métiers	Hybridization of PEM hydrogen fuel cell and supercapacitors for maritime applications	Pierre Garambois, Lionel Roucoules, Florian HUET	LISPEN - Laboratoire d'ingénierie des systèmes physiques et numériques
2022_073	Mines Paris - PSL	Modelling and Optimization of Memory Accesses on Multi-level Memory Parallel CPUs	Claude TADONKI	CRI - Centre de recherche en informatique
2022_082	Mines Paris - PSL	Wearable Sensing and Movement Analytics for the Monitoring of Operators/Experts in industry and crafts	Alina Glushkova	CAOR - Centre de Robotique

# ROOM2 - Information and Communication Science and Technology + Mathematics and their applications + Energy, Processes + Design, Industrialization- PROPOSALS/LABS 2/2

File Number	School	Title	Advisors	Lab
2022_014	ESPCI Paris - PSL	Intelligent Reflecting Surfaces for Backscatter telecommunications	Julien de Rosny, Abdelwaheb Ourir	Institut Langevin
2022_019	Arts et Métiers	Developing serious games for teaching interactive product design	Camille JEAN, Lou Ruding, Frédéric SEGONDS	LCPI - Laboratoire conception de produits et innovation
2022_021	Arts et Métiers	Data-Driven Adaptive Statistical Process Control for Smart Manufacturing	Jean-Yves DANTAN, Lazhar HOMRI, Wahb ZOUHRI	LCFC - Laboratoire de conception, fabrication, commande
2022_041	Arts et Métiers	Innovative Design for Additive Manufacturing through Knowledge Management and Artificial Intelligence	Ali Siadat, Alaa Hassan	LCFC - Laboratoire de conception, fabrication, commande
2022_046	Arts et Métiers	How adapt reconfigurable production systems to product variability and improve scalability and reusability of RMS	Jean-Yves Dantan, Paul Stief, Ali SIADAT	LCFC - Laboratoire de conception, fabrication, commande
2022_071	Arts et Métiers	Design a safe work-cell for human-robot co-activity in industry	Thibaut RAHARIJAONA, Adrien KOESSLER, Paul STIEF	LCFC - Laboratoire de conception, fabrication, commande
2022_087	Arts et Métiers	Dynamic behavior models for industrial forging processes	Régis Bigot, Durand Camille	LCFC - Laboratoire de conception, fabrication, commande
2022_088	Arts et Métiers	Surrogate models for industrial metal forming processes optimization	Tudor Balan, Cyrille Baudouin, Lazhar Homri	LCFC - Laboratoire de conception, fabrication, commande
2022_089	Arts et Métiers	Real-time model development for incremental sheet metal forming	Tudor Balan, Sandra Chevret	LCFC - Laboratoire de conception, fabrication, commande
2022_093	Arts et Métiers	How to integrate robots to the co-design of product variety and its reconfigurable manufacturing systems (RMS)	Jean-Yves DANTAN, Paul STIEF, Adrien KOESSLER	LCFC - Laboratoire de conception, fabrication, commande
2022_101	Arts et Métiers	Risk management of engineering products driven by artificial intelligence	Ali SIADAT, Jelena PETRONIJEVIC, Alain ETIENNE	LCFC - Laboratoire de conception, fabrication, commande
2022_037	Arts et Métiers	Improving formability of lightweight metallic materials using process chaining: Incremental Forming and Friction Stir Welding	Philippe Dal Santo, Idriss Tiba, Sandra Chevret, Tudor Balan	LAMPA - Laboratoire angevin de mécanique, procédés et innovation
2022_048	Chimie ParisTech - PSL	Charge Transport in Organic Photovoltaics: from modeling to rationale design	Carlo Adamo	I-CLEHS - Institute of chemistry for life and health

# ParisTech

#Connect

#Innovate

#Share

[www.paristech.fr](http://www.paristech.fr)



# ENSAM LAB: LCFC - LABORATOIRE DE CONCEPTION FABRICATION COMMANDE

Lab Director :

Ali SIADAT

Ali.SIADAT@ensam.eu

RESEARCH TOPICS

## RESEARCH AXES

Design

Manufacturing

Control

Manufacturing process **robotics**

Innovative **forming process** development and optimization

Manufacturing process **modeling and characterization**

System design under uncertainties based on ML and **safe system design**

Improvement and optimization of **safe and reliable production systems**



# ENSAM LAB: LCFC - LABORATOIRE DE CONCEPTION FABRICATION COMMANDE

Lab Director :

Ali SIADAT

Ali.SIADAT@ensam.eu

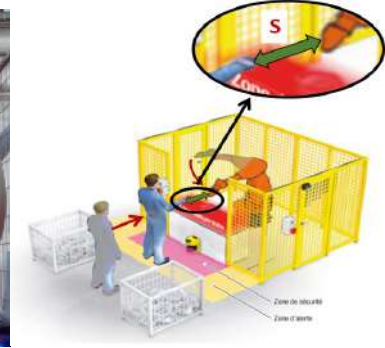
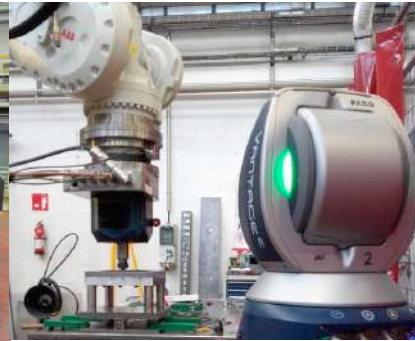
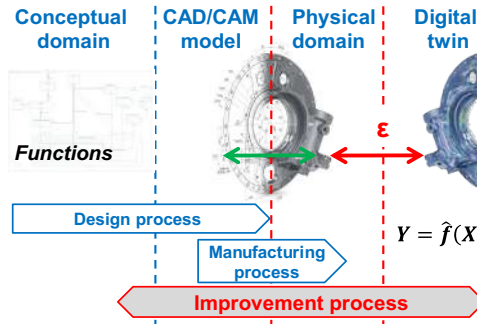
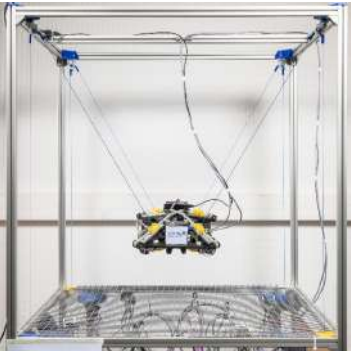

## Major ongoing projects:

- 5 ANR projects (4 × coordinator)
- 7 CIFRE/industrial theses
- 1 IC Arts structural project
- 2 RDI projects
- 1 Industrial chair

## Key indicators:

- 7 prof + 20 ass prof (2 HDR) + 2 prag dr
- 24 PhD students
- annual budget ~1M€ (65% industrial partnership)
- 2 joint labs (LC2S/INRS, LAMFM/CETIM)
- 20...25 articles in international journals / year
- Int. conf organizer (2022: "CIRP" conf CA tolerancing)



# ENSAM LAB: LCFC - LABORATOIRE DE CONCEPTION FABRICATION COMMANDE

Lab Director :

Ali SIADAT

Ali.SIADAT@ensam.eu

## Industrial partners:



## Public institutions/ RTO/ academic :





# ParisTech

#Connect

#Innovate

#Share

[www.paristech.fr](http://www.paristech.fr)



**ParisTech**  
#Connect #Innovate #Share



LABORATOIRE D'INGÉNIERIE DES FLUIDES ET DES SYSTÈMES  
ÉNERGÉTIQUES - LIFSE

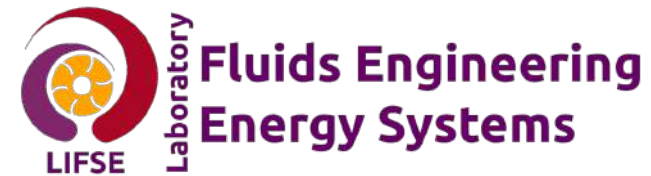

Research domain(s): The LIFSE's main research areas revolve around hydrodynamics, aerodynamics, acoustics, thermics and thermodynamics, implemented for the turbomachines development as well. These research areas are a part of the renewable energy fields, sustainable mobility, aerospace, processes and health.

### Turbomachines

Topic leaders

Dr Amélie DANLOS  
Pr Sofiane KHELLADI

### Energy systems and thermal management

Topic leaders

Dr Michael DELIGANT  
Dr Christelle PERILHON

### Multi-species flows and rheology

Topic leaders

Pr farid BAKIR  
Dr Mathieu SPECKLIN

### Physical aero-hydrodynamics

Topic leaders

Dr Florent RAVELET  
Dr Michael PEREIRA

**RESEARCH INFRASTRUCTURES**  
*(Confluence Platform)*

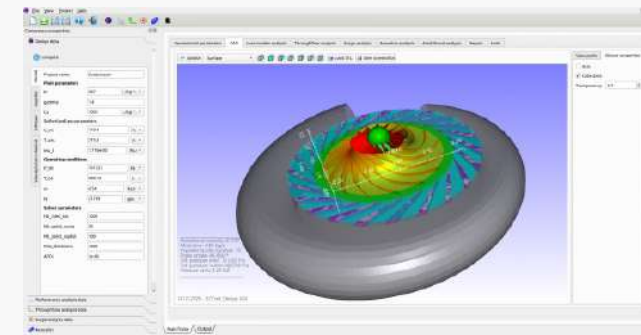

## KEY FACTS / FIGURES



15 researchers / 16 teacher-researchers  
(including 80% of international researchers /  
37% of teacher-researchers)  
24 doctoral students including 75% of  
international doctoral students



35-45 publications/year  
50% international co-publications



22 patents

Sample typical research projects:

see more details on

<https://lifse.artsetmetiers.fr/>

## PhD subject : Intelligent Haptics for the Perception of Fluid Properties

**Advisors:**

- Dr. Samir GARBAYA
- Pr. Sofiane KHELLADI

- **Context:**

- Haptic sensation is important for the perception of the physical properties of virtual objects. Natural user interfaces allowing high fidelity of haptic sensation of fluids' properties still not available

- **Objectives:**

- This PhD will focus on the development of modeling methodologies of virtual fluids and the design novel 3D interaction techniques for haptic feedback
- This research includes :
  - Integration machine learning and Extended-Reality in the Human-Computer Interaction
  - Development of new methods of hydrodynamics modeling and of mechanisms of sensory integration for the perception of fluids' properties
  - Validation of the research results with the application in medical domain

# HAPTIC RENDERING

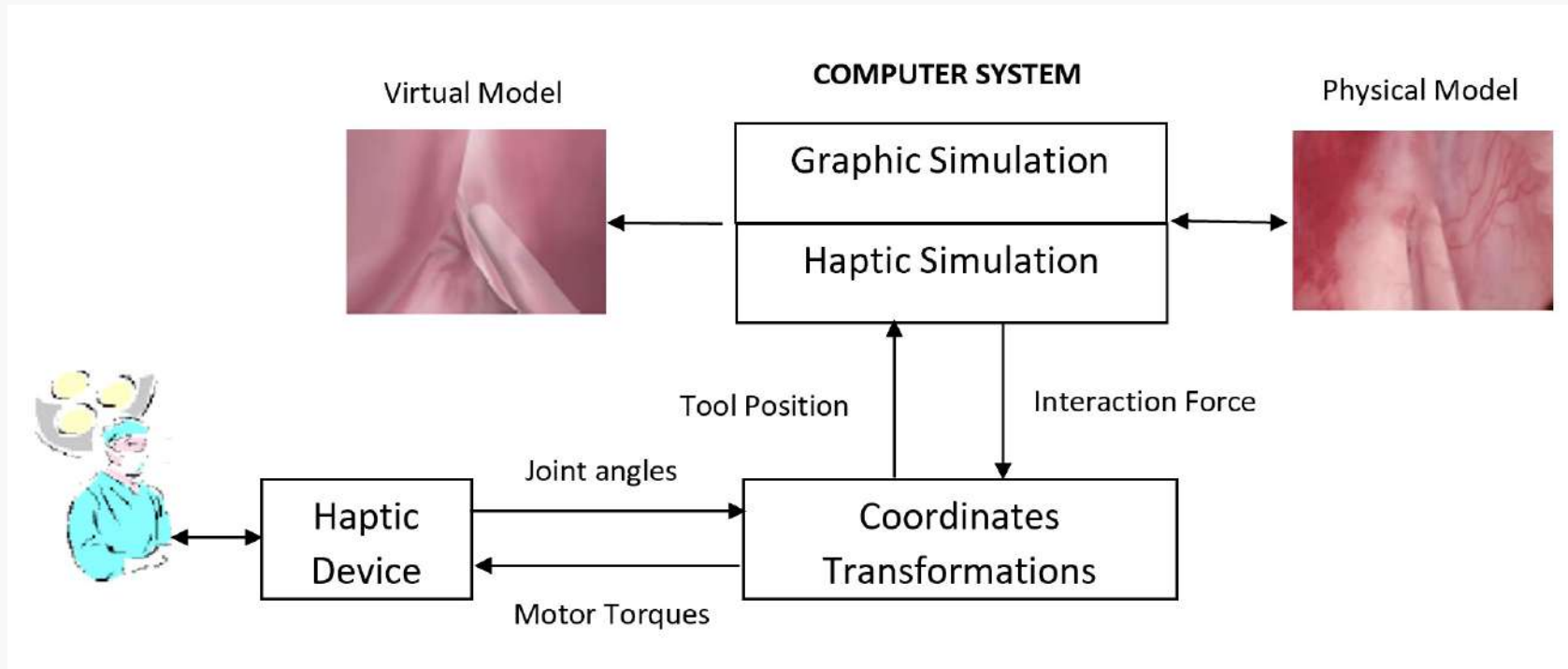



# REFERENCES

- Bertelson, Paul, and Béatrice De Gelder, 'The Psychology of Multimodal Perception', in Charles Spence, and Jon Driver (eds), Crossmodal Space and Crossmodal Attention (Oxford, 2004; online edn, Oxford Academic, 22 Mar. 2012),.
- Samir Garbaya and Ulises Z. Colado, “The affect of contact force sensations on user performance in virtual assembly tasks”, Virtual Reality, Special Issue on Virtual Manufacturing” Volume 11, Number 4 / October 2007, pp. 287-299
- Germanico Gonzalez-Badillo, Hugo Medellin-Castillo, Theodore Lim, James Ritchie, Samir Garbaya, "The development of a physics and constraint-based haptic virtual assembly system", Assembly Automation, Vol. 34 Iss: 1, pp.41 - 55, 2014
- Samir Garbaya, Chekra MIRAOUI, Robert WENDRICH, Theodore LIM, Ioana Andreea STĂNESCU, and Jannicke Baalsrud HAUGE, “Sensorial Virtualization: Coupling Gaming and Virtual Environment”, Journal of Advanced Distributed Learning Technology (JADLET), Volume 2, Number 5, 2014
- Samir Garbaya and Vincent Hugel, “Modelling Movement Time for Haptic-enabled Virtual Assembly”, the International Conference on Human Computer Interaction Theory and Applications (HUCAPP), 27-29 February 2020, Valletta, Malta
- Lundin, Karljohan & Sillén, Mattias & Cooper, Matthew & Ynnerman, Anders & Visualization, Norrköping & Studio, Interaction & Sweden, (2005). Haptic visualization of computational fluid dynamics data using reactive forces. Proceedings of SPIE - The International Society for Optical Engineering. 5669. 10.1117/12.587029.
- Liu, S., Ma, C. & Feng, G. Haptic rendering for the coupling between fluid and deformable object. Virtual Reality 23, 33–44 (2019),

# CSC programme

## Optimization of an overspray system for turbomachines applications

**Prof. Sofiane Khelladi, Professeur des Universités**  
**Dr. Tommaso Capurso, Enseignant-chercheur**

Laboratory of Fluid Engineering and Energy Systems (LIFSE lab)  
Arts et Métiers Institute of Technology, LIFSE

sofiane.khelladi@ensam.eu  
tommaso.capurso@ensam.eu

# Centrifugal compressor - Humidification

Cooling by water injection.

Pros: reduction of the inlet air temperature ( $T_{in}$ ).

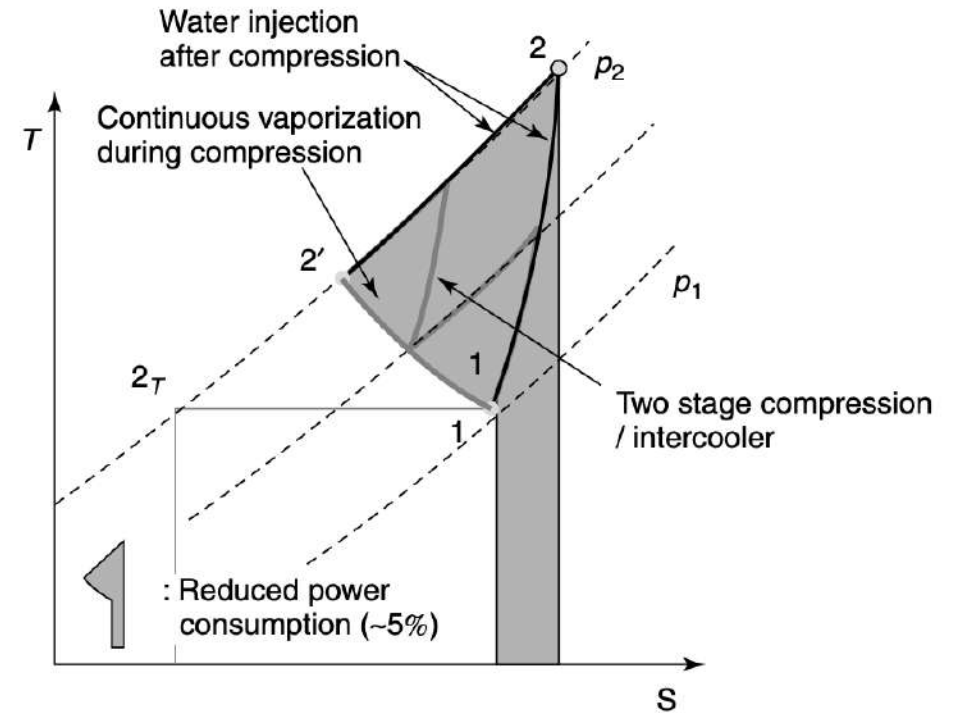
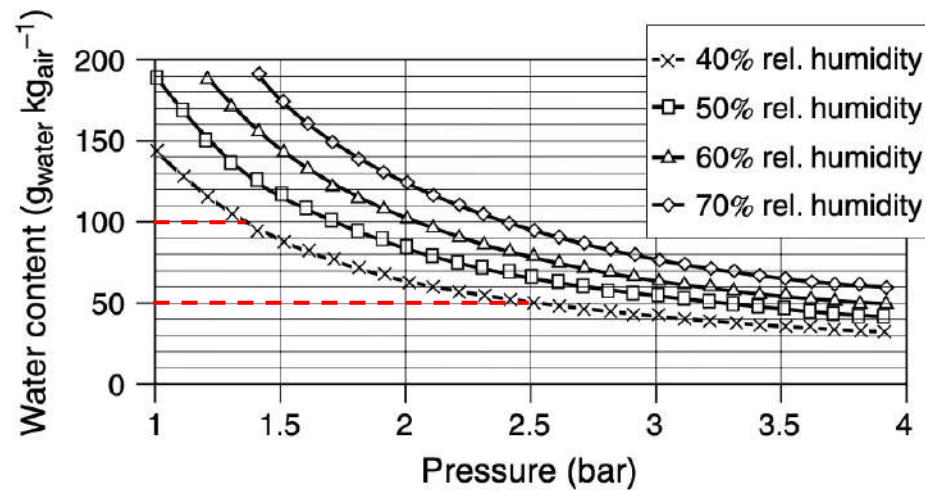

# Work flow

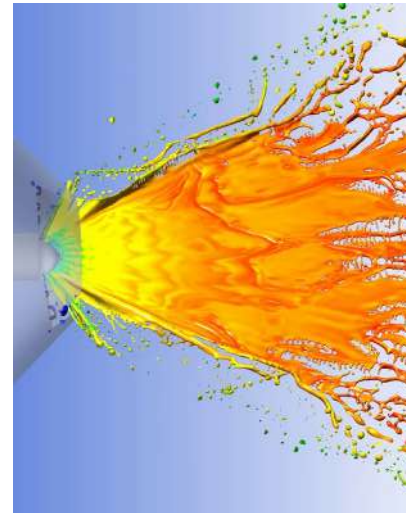
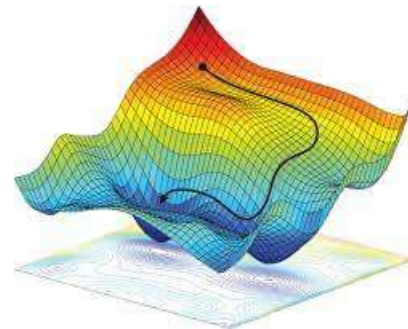
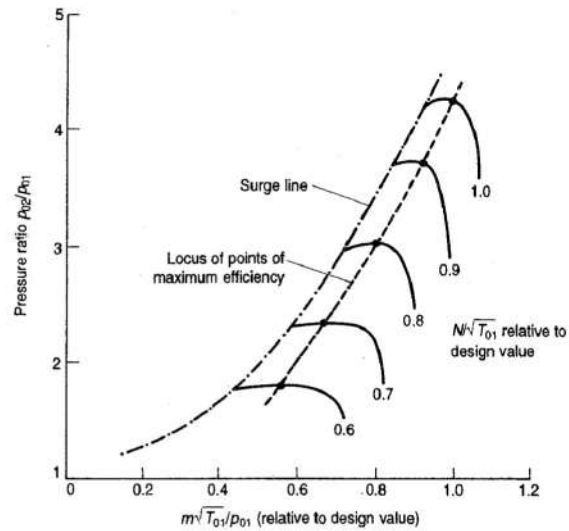
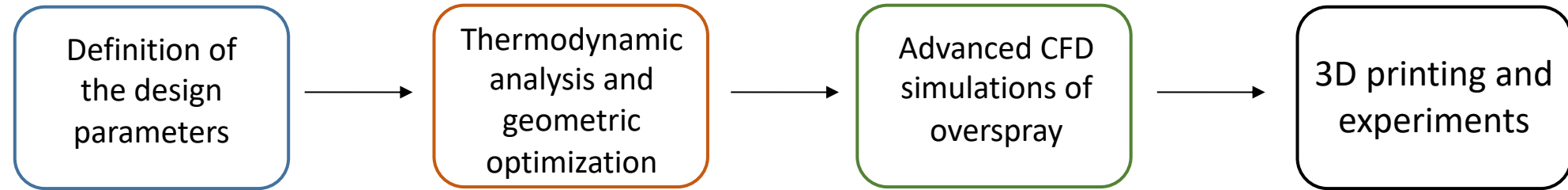

# ParisTech

#Connect

#Innovate

#Share

[www.paristech.fr](http://www.paristech.fr)



ParisTech  
#Connect #Innovate #Share



CENTRE DE RECHERCHE EN INFORMATIQUE

CRI

Research domain(s): *Program transformations; high-performance computing; proof; cryptography; database*

High-Performance Computing  
(Parallel programming and supercomputers)

Team



François Irigoien  
Corinne Ancourt  
Claude Tadonki

Security  
(Proof and checking)

Team



Pierre Jouvelot  
Olivier Hermant

Languages  
(Cryptography and database)

Team



Fabien Coelho  
Laurent Daverio  
Claire Medrala

## RESEARCH INFRASTRUCTURES



**CALCUTTA** PowerEdge T640



**BUENAVISTA** Precision 3650

## KEY RESEARCHER (S)



**FRANÇOIS IRIGOEN**  
H-INDEX: 25  
#CITATIONS: 3467



**PIERRE JOUVELOT**  
H-INDEX: 26  
#CITATIONS: 3901



## KEY FACTS / FIGURES



6 researchers  
12 doctoral students including 30% of international doctoral students



Prestigious partnerships



Number of publications: 330  
Number of international co-publications: 300



THALES



International collaboration: *UK; USA; Brazil; Morocco; Poland; ...*

## Sample typical research projects

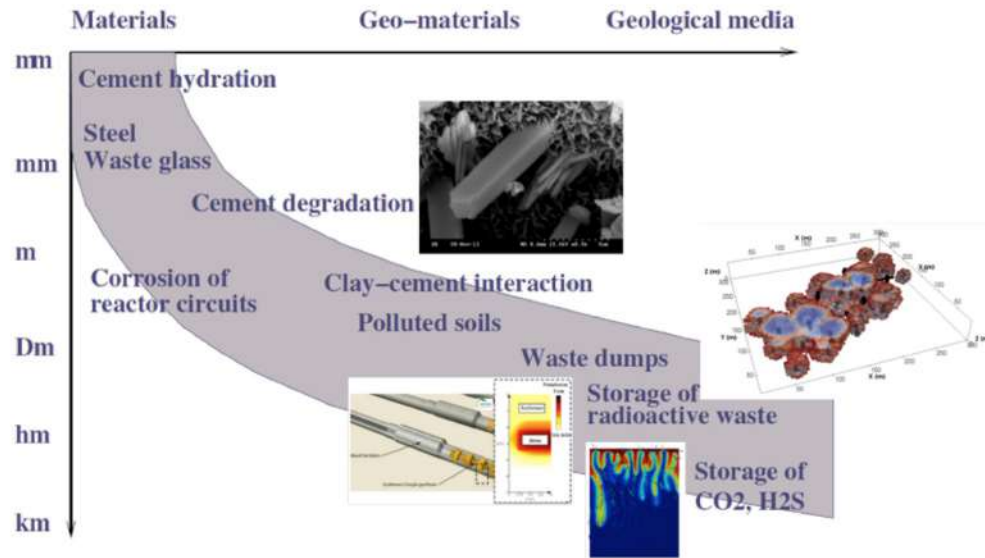

**Theme:** Transports of reagents (simulation)  
**HPC in material sciences**



**Theme:** Autonomous vehicles  
**Proof in artificial intelligence**

# ParisTech

#Connect

#Innovate

#Share

[www.paristech.fr](http://www.paristech.fr)



# Wearable sensing and movement analytics for the monitoring of operators/experts in industry and crafts

## Professional gestures

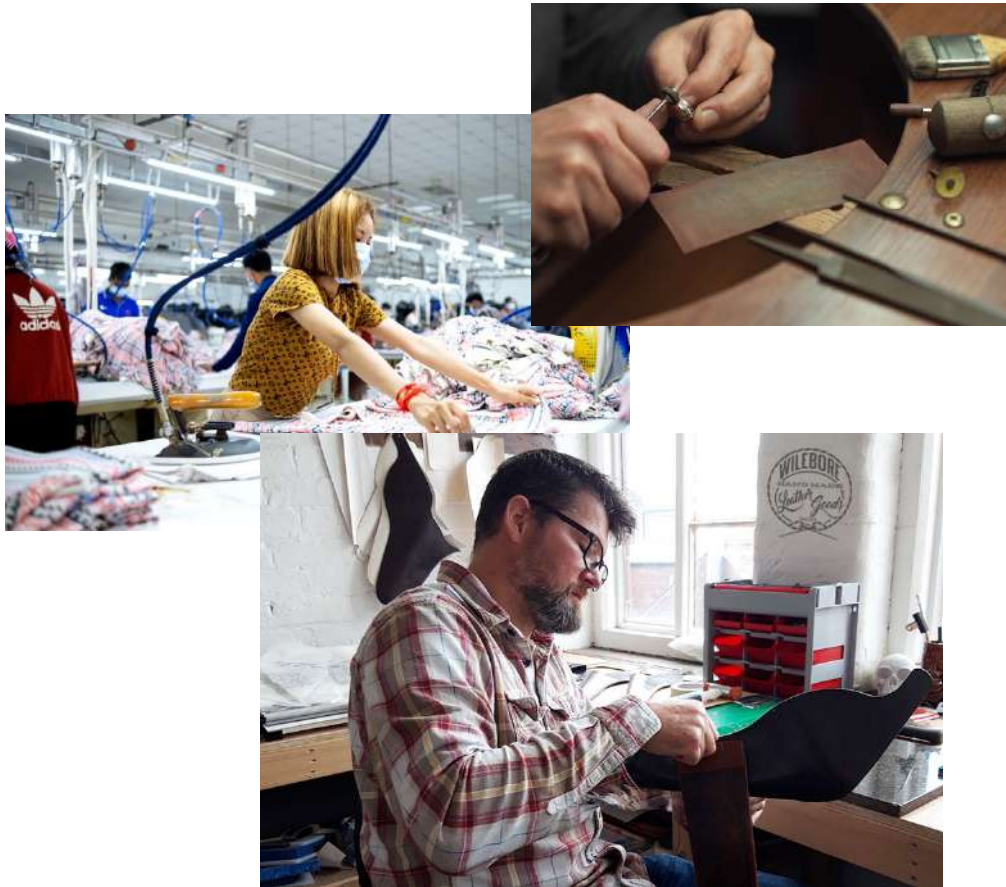

## Operators:

> embody dexterity and technicality

## However they are:

> exposed to ergonomics risks  
(loading charge, uncomfortable postures, repetitive gestures etc.)

Monitoring & analyzing their activity  
contribute to the prevention of MSDs

# Wearable sensing and movement analytics for the monitoring of operators/experts in industry and crafts

## Capture professional gestures with wearable sensing



## Capture signal from various multi sensing technologies such as

- IMUs (gyroscopes, accelerometers, magnetometers)
  - Heart rating sensors
  - Electromyographs
  - Breath monitoring belts
- By using
- Smartphones
  - Smartwatches
  - etc.

#signal processing #timeseries #datafusion

# Wearable sensing and movement analytics for the monitoring of operators/experts in industry and crafts

**Develop a methodology for the analysis of professional gestures**  
**Develop a platform for ergonomists/trainers to better understand motor performance**

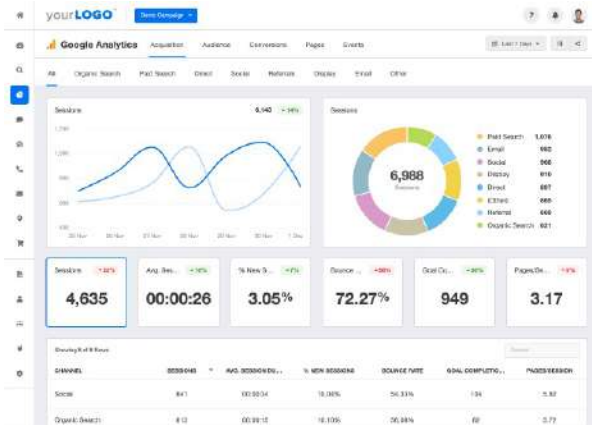

**Use of machine learning and pattern recognition techniques**

**Detect automatically the correlations between:**  
**> motion features**  
**> internal/external human factors (time pressure, emotional state etc.)**

#signal processing #timeseries #datafusion

## Indicative bibliography

Stefana, E., Marciano, F., Rossi, D., Cocca, P., & Tomasoni, G. (2021). Wearable devices for ergonomics: A systematic literature review. *Sensors*, 21(3), 777.

Metcalf, C. D., Irvine, T. A., Sims, J. L., Wang, Y. L., Su, A. W., & Norris, D. O. (2014). Complex hand dexterity: a review of biomechanical methods for measuring musical performance. *Frontiers in psychology*, 5, 414.

Ju, Z., & Liu, H. (2013). Human hand motion analysis with multisensory information. *IEEE/AsMe Transactions on Mechatronics*, 19(2), 456-466.

Chen, Q., Albarakati, A., & Gui, L. (2021). Research on motion capture of dance training pose based on statistical analysis of mathematical similarity matching. *Applied Mathematics and Nonlinear Sciences*.

Dingwell, J. B., & Cusumano, J. P. (2000). Nonlinear time series analysis of normal and pathological human walking. *Chaos: An Interdisciplinary Journal of Nonlinear Science*, 10(4), 848-863.

# ParisTech

#Connect

#Innovate

#Share

[www.paristech.fr](http://www.paristech.fr)





ParisTech  
#Connect #Innovate #Share



LABORATOIRE ANGEVIN DE MÉCANIQUE, PROCÉDÉS ET INNOVATION / INSTITUTE OF LAVAL



# Laboratory of mechanics, processes and innovation



## KEY FACTS / FIGURES



44 researchers including 7 foreigners  
22 doctoral students including 10 foreigners



124 publications in scientific review since 2018



Three filed patents

## Future manufacturing processes

Complex structures and flows

Team leader



Laurent Guillaumat

Metal structures and alloys

Team leader



Guénaël Germain

Presence & Innovation

Team leader



Simon Richir

# Team « Presence & Innovation »

## RESEARCH INFRASTRUCTURES (Laval Virtual Center)

## KEY RESEARCHERS



SIMON RICHIR / *impact factor 21*

SYLVAIN FLEURY / *impact factor 9*

## INEDIT Project



Development of virtual reality applications for furniture design.

Assessment of VR tools to improve creativity process and to make design of furniture possible for non-professional designers

- Fleury, S., Blanchard, P., & Richir, S. (2021). A study of the effects of a natural virtual environment on creativity during a product design activity. *Thinking Skill and Creativity*.
- Fleury, S., Poussard, B., Blanchard, P., Dupont, L., Meister Broekema, P., & Richir, S. (2022). Innovative process for furniture design: contribution of 3D scan and virtual reality. *Computer-Aided Design and Applications*, 868-878, doi: 10.14733/cadaps.2022.868-878
- Fleury, S., Dupont, L., Chaniaud, N., Tamazart, S, Poussard, B., Gorisse, G., & Richir, S. (2022). An investigation of design in virtual reality across the variation of training degree and visual realism. *International Conference on Engineering Technology and Innovation*.
- Pallot, M., Fleury, S. Poussard, B., & Richir, S. (2022). What are the Challenges and Enabling Technologies to Implement the Do-It-Together Approach, its Benefits and Drawbacks? *Journal of Innovation Economics & Management*.

## JENII Project



- Development of virtual reality applications for engineers students training.
- Assessment of VR simulators as way to learn processes and concepts.



We will acquire volumetric capture equipment

We want to develop **the first MOOC in VR** by capturing a teacher giving a lesson.

The thesis is **about the way to enhance the MOOC VR** by adding highlights, guidings or other improvements and **to evaluate its efficacy for learning.**



# ParisTech

#Connect

#Innovate

#Share

[www.paristech.fr](http://www.paristech.fr)



in



f



ParisTech  
#Connect #Innovate #Share



LABORATOIRE D'INGÉNIERIE DES SYSTÈMES PHYSIQUES ET  
NUMÉRIQUES – LISPEN

*PHYSICAL AND DIGITAL SYSTEMS ENGINEERING  
LABORATORY*



Prof. Jean-Philippe PERNOT

Research domain(s): Multi-physics, multi-scale and virtual dynamical systems for industry

Robotics, HRI, industrial engineering  
Nonlinear dynamics and smart systems

Team leader



Prof. Richard Béarée

System engineering and digital model,  
industrial engineering

Team leader



Prof. Lionel Roucoules

Virtual Immersion technologies and uses

Team leader



Prof. Frédéric Merienne

## RESEARCH INFRASTRUCTURES

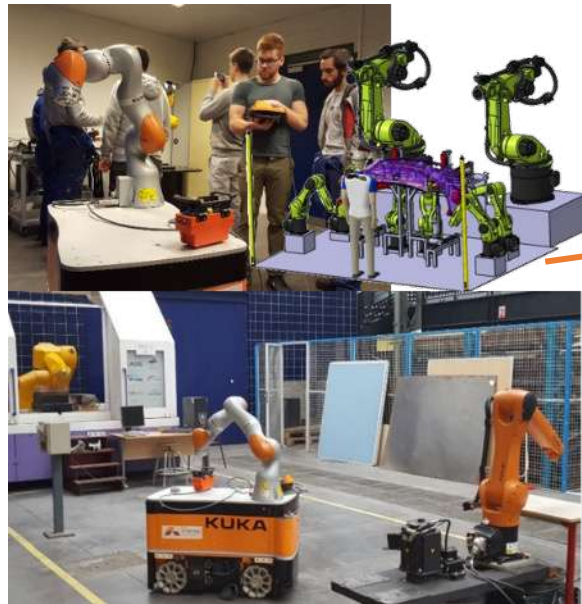

Lille



Chalon-sur- Saône



Aix-en-Provence

## KEY FACTS / FIGURES



Number of researchers / teachers : **31**  
Number of doctoral students : **42** including  
25% of international doctoral students  
Number of post-docs : **3**



Prestigious partnerships with academic  
laboratories



Number of publications > **600**  
Number of international co-publications > **40**



Lab's or staff's' recent Awards

- **Automotive News PACE Award 2022** (Chaire Valéo)
- Active and funded member of **2 EQUIPEX+** (CONTINUUM & TIRREX)
- **H2020 EU project leader** – Colrobot 2015-2019
- **Safran innovation award 2018**



## Sample typical research projects :

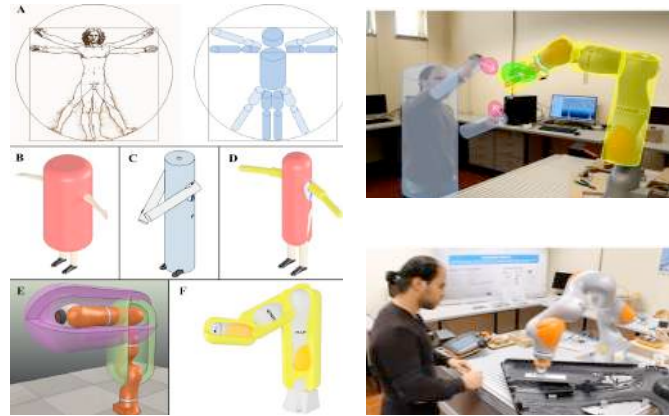

Mohammad Safeea's Joint PhD supervision with Univ. Of Coimbra (Portugal)

« Safe Collaborative Robotic Manipulators » 2017-2020

7 papers in top10 Robotic's journals;  
4 communications in int. conf. (ICRA, IROS), 6 book chapters



Yuyang Wang – PhD granted by CSC

« Smart navigation in virtual environment »  
2018-2021

1 paper (IEEE Access)  
3 Communications in int. conf. (IEEE VR, ICITS)

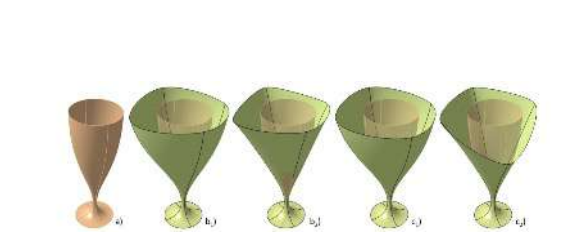
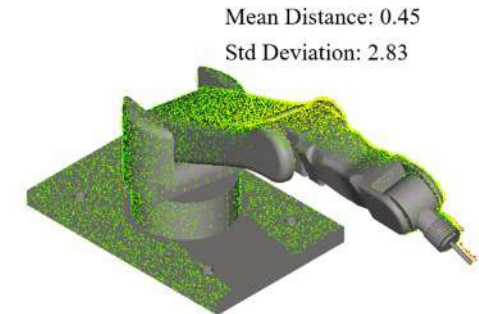

Fig. 7. Results of the simulation after removing constraints with  $\theta_{max} = 45^\circ$  initial state. (a) configuration 1 and reconstruction of its shape variability; (b) configuration 2 and reconstruction of the shape variability; (c) configuration 3 and reconstruction of the shape variability; (d) configuration 4 and reconstruction of the shape variability; (e) configuration 5 and reconstruction of the shape variability.

Hao HU – PhD granted by CSC

« Over-constraints detection and resolution in geometric equation systems »  
2014-2017

2 papers in high impact factor journals (Computer-Aided Design, Archives of Computational Methods in Engineering)



Sijie HU – PhD granted by CSC

« Deep learning-based identification and fitting of CAD models from point clouds »  
2019 - 2020

1 paper (Engineering with computers)

## Ongoing research projects :



Tingcheng LI – PhD granted by CSC

« *Deep Learning for 3D Scanning Strategies Quality Estimation* » 2020-2024

1 paper (Computer-Aided Design) and 1 to be submitted

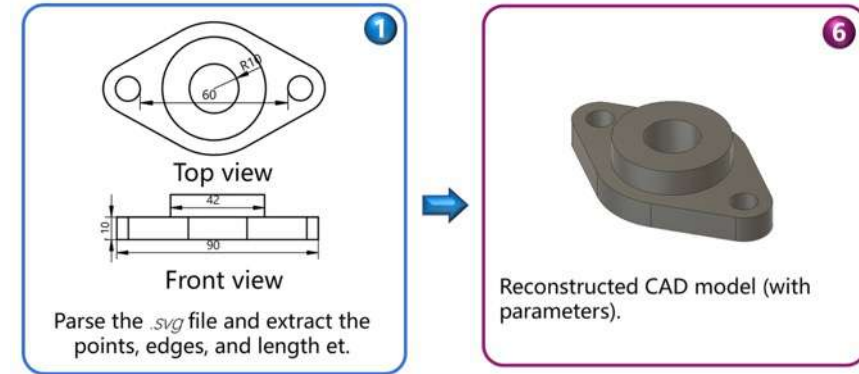

Chao ZHANG – PhD granted by CSC

« *Deep-learning based 3D CAD models reconstruction from 2D drawings* » 2021-2025

1 paper under submission

## PhD subject: Geometry processing for reducing cybersickness in VR

Scientific issue: Sensory conflict and cybersickness

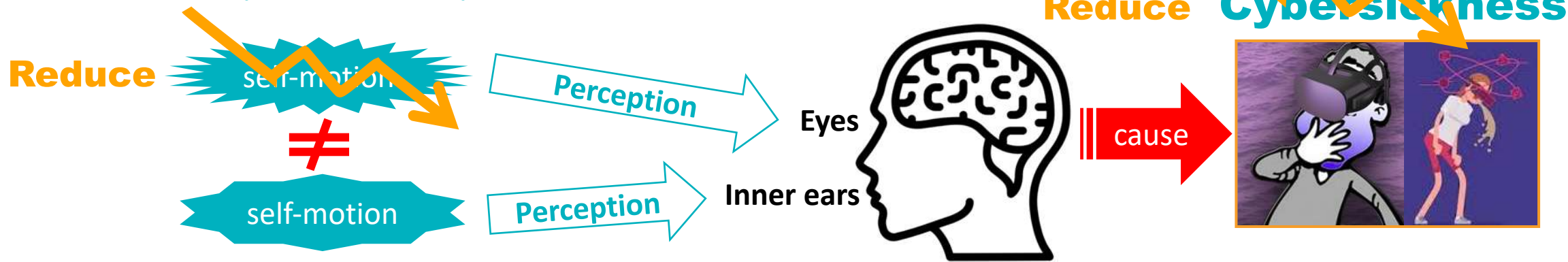

Proposed approach: apply geometry processing on the virtual scene

- Pilot studies: manual geometric **deformation** and **simplification** proposed in the literature (papers below)
- For this **PhD subject**:
  - How to **analyze** geometrically the virtual scene regarding to potential cybersickness ?
  - How to automatically **process** geometrically the virtual scene for reducing cybersickness ?
    - which strategy (simplification, deformation or others) ?
    - What are the algorithms for each strategy ?
  - What are the **parameters** that users can set up ?

Dr. Ruding Lou  
Prof. Frédéric Mérienne

## PhD subject: Geometry processing for reducing cybersickness in VR

Team: Virtual Immersion  
- Dr. Ruding Lou  
- Prof. Frédéric Mérienne

### Context

Immersive visualization => visually induced self-motion (vection)



Physically statistic: Using VR input device to move in virtual environment

Scientific issue: **Sensory conflict** and cybersickness

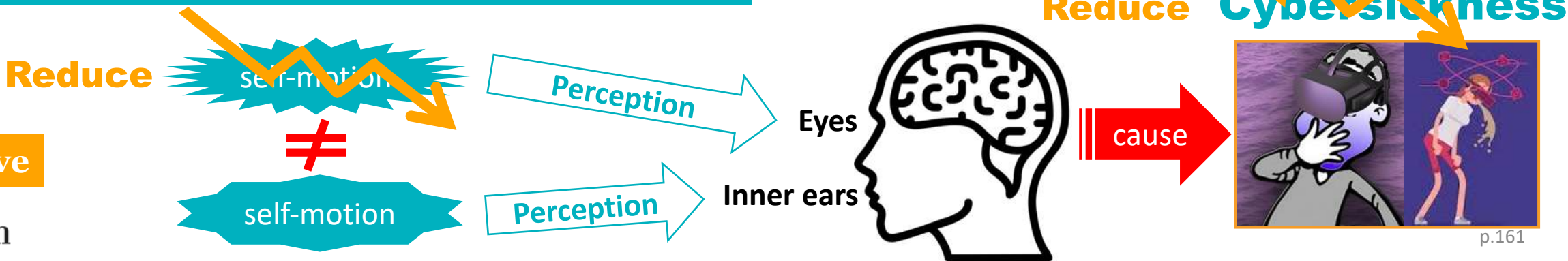

VR: Virtual reality, CAVE: Cave automatic virtual environment, HMD: Head-mounted display



## PhD subject: Geometry processing for reducing cybersickness in VR

### Proposed approach: geometry processing of the virtual scene

Team: Virtual Immersion  
- Dr. Ruding Lou  
- Prof. Frédéric Mérienne

- Pilot studies through manual processing proposed in the literature (papers below)
  - **deformation** (Eurographics'22)

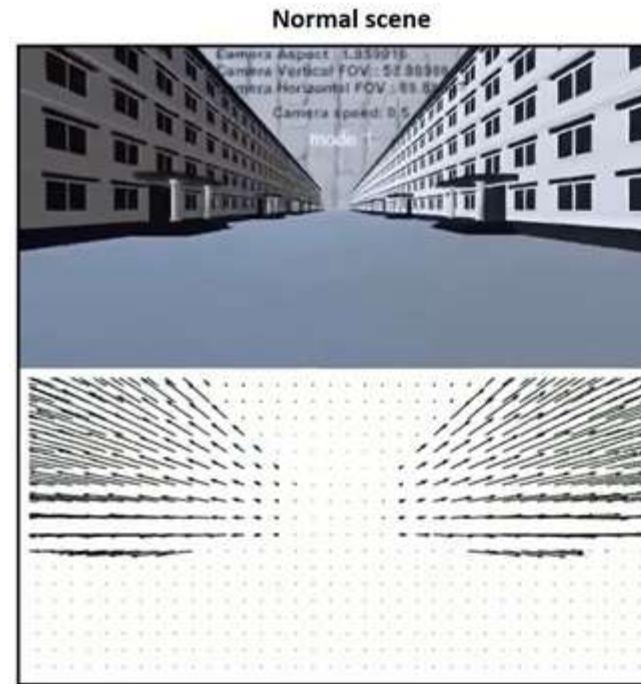
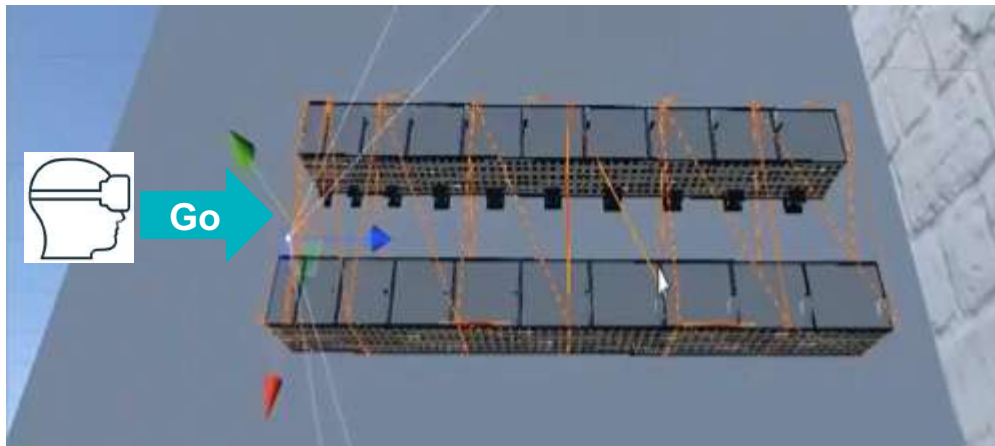

Analysed optic flow

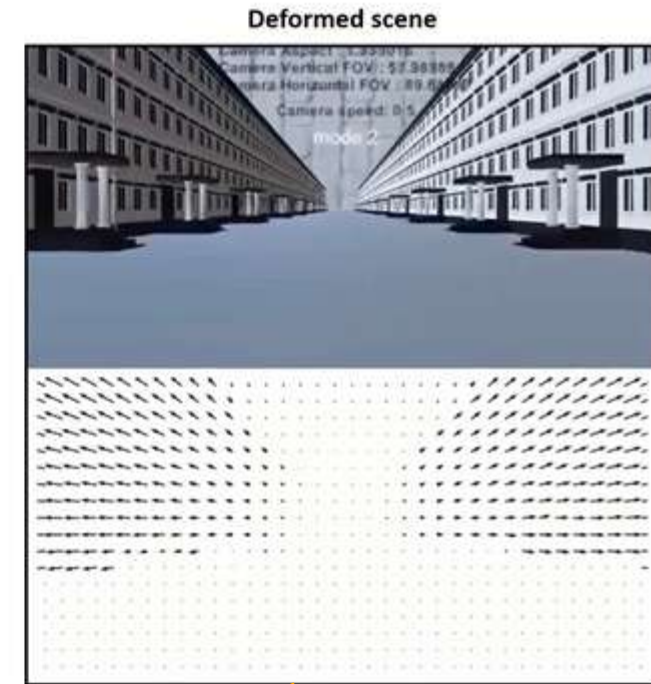

Analysed optic flow

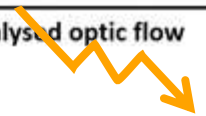

## PhD subject: Geometry processing for reducing cybersickness in VR

Team: Virtual Immersion  
- Dr. Ruding Lou  
- Prof. Frédéric Mérienne

### Proposed approach: geometry processing of the virtual scene

- Pilot studies through manual processing proposed in the literature (papers below)
  - **Simplification** (ISMAR'22)

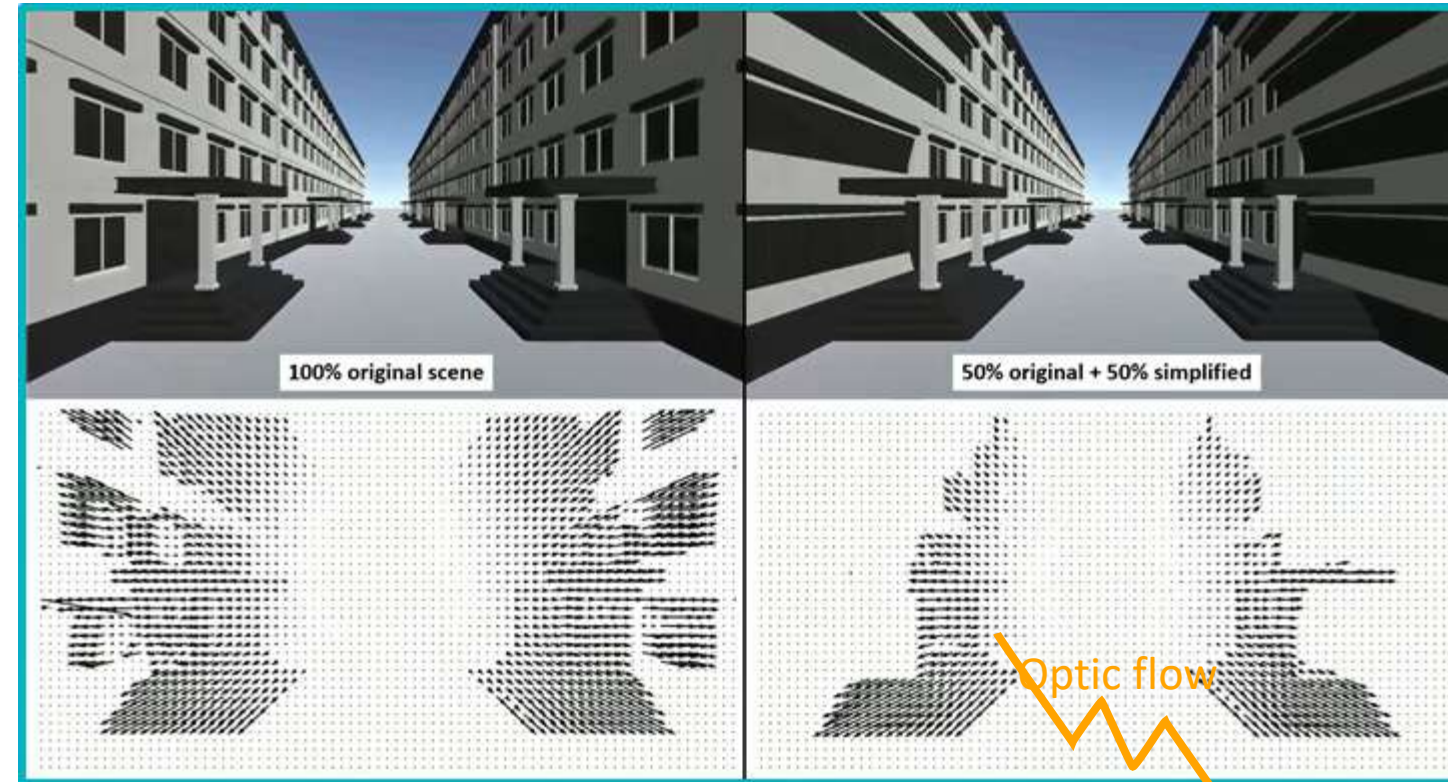
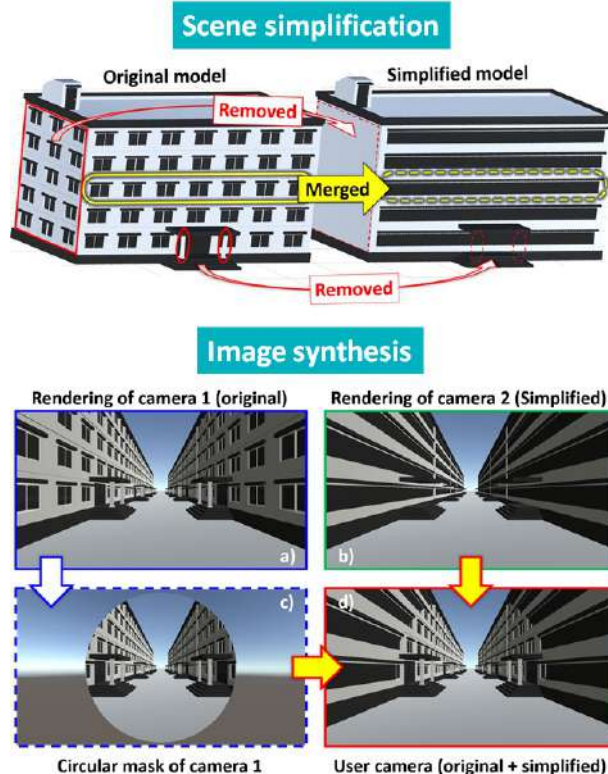

## PhD subject: Geometry processing for reducing cybersickness in VR

Team: Virtual Immersion  
- Dr. Ruding Lou  
- Prof. Frédéric Mérienne

### Aim of this PhD subject

- Automation of **analysis** and **segmentation** of virtual scene regarding to optic flow.
- Automation of geometry **processing** of the virtual scene for reducing optic flow ?
  - which strategy (simplification, deformation, ...) ?
  - What are the algorithms for each strategy ?
- How the geometry processing can **mitigate the cybersickness**
  - Experimentation
  - Psychological and physiological analysis
  - Data analysis
- What are the **parameters** that users can set up ?
  - Level of sensitivity to cybersickness
  - Degree of geometry processing

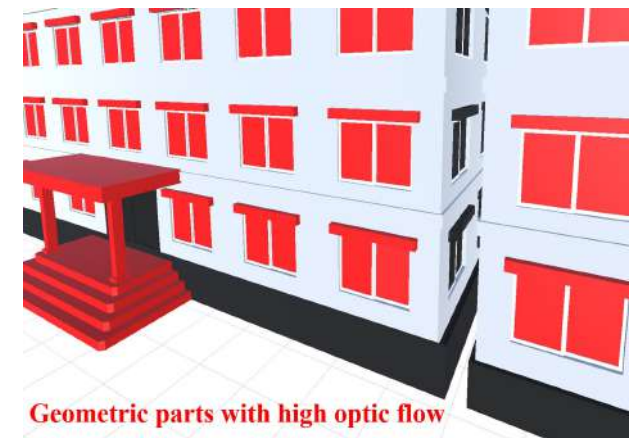
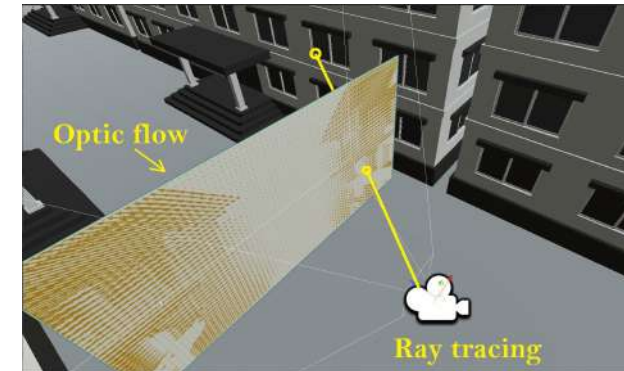

Thanks

## PhD subject : Graph-based unbounded constrained models search for high-level logical reasoning

- formal AI theoretical, algorithmic and programming subject
- applications to cyber-physical systems & software engineering, natural language parsing & generation, etc.

*Advisors* : Prof. Jean-Philippe Pernot, Dr. Mathias Kleiner

*Requirements* : Strong algorithmic and programming (C, Java) skills, knowledge of formal AI

· Laurent Hénocque, Mathias Kleiner, Nicolas Prcovic, “Advances in polytime isomorph elimination for configuration”, Principles and Practice of Constraint Programming-CP 2005, p. 301-313, Springer, 2005.

· Mathias Kleiner, Marcos Didonet Del Fabro, “A generic approach to model generation operations”, Journal of Systems and Software, p 136-155, Elsevier, 2018.

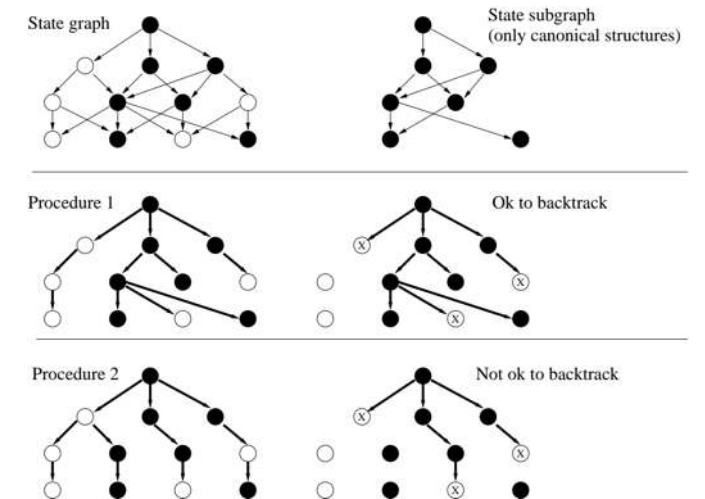
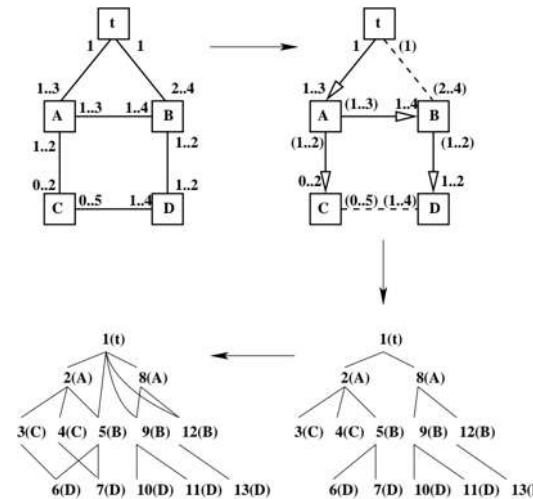

**PhD subject : Reinforcement learning-based 3D reconstruction of CAD models from dead models for smart manufacturing applications**

Research question : How to reverse engineer a dead CAD model to identify the building tree ready for manufacturing ?

Methodology : Make use of reinforcement learning to learn how to define such building tree with a small dataset

- How to define the environment ?
- Which actions for the agent ?
- Rewards ?
- Etc.

In collaboration with

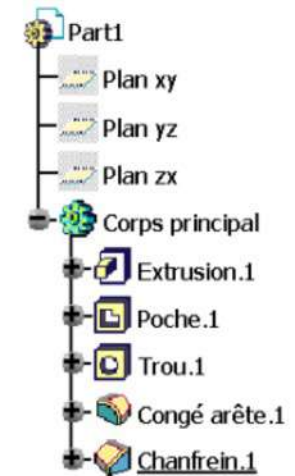
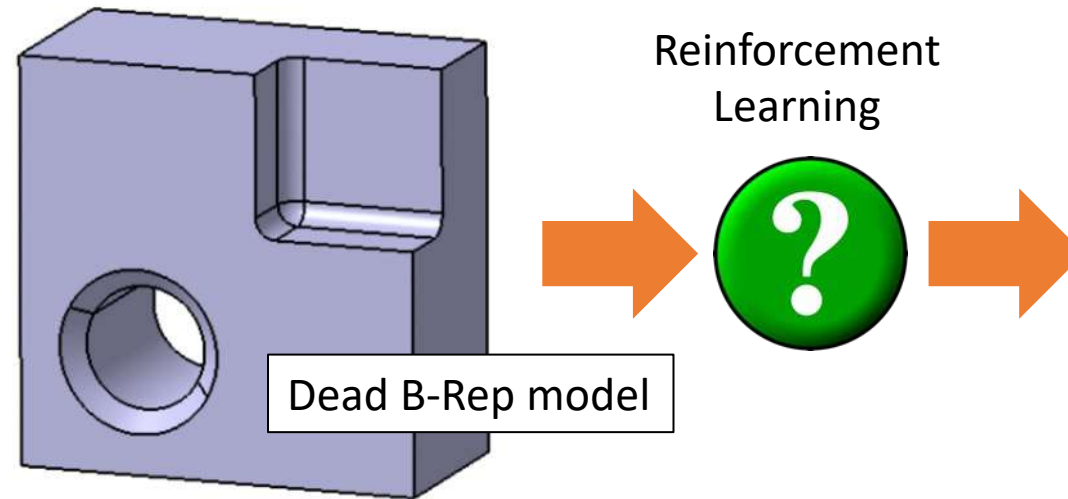

Building tree ready for manufacturing process planning

**Required background:** Computer science, geometric modeling, computer-aided design.

**PhD subject : Topology-preserving non-rigid deformation of CAD models from point clouds for first-time-right production in smart manufacturing**

Research question : How a CAD model can be adapted and deformed to capture the manufacturing defaults and thus maintain the coherence between the digital model and its physical and manufactured counterpart ? And how this can be used to compensate the shape deviations and allow first-time-right production ?

Methodology :

- Definition of new deformation operators to simulate and reproduce various state-of-the-art manufacturing behaviors and deviations, including free-form and non-rigid deformations, and preserving the topology
- Use of a reinforcement learning strategy, wherein an autonomous agent will learn how to define the deformation sequence to be applied to compensate the coming shape deviations between the theoretical model and its manufactured counterpart.

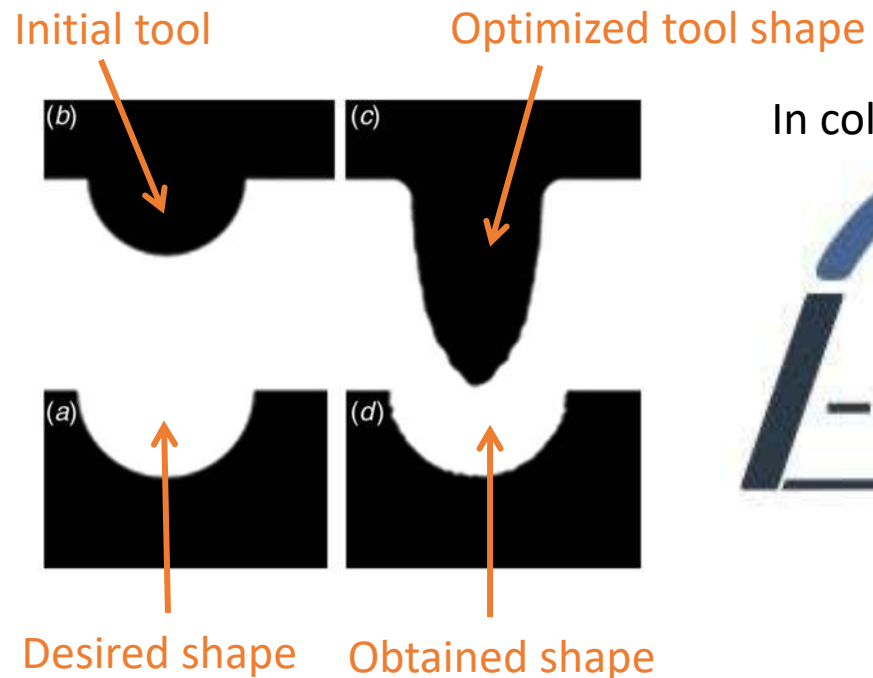

In collaboration with





## ZOOM ON INDUSTRIAL ENGINEERING

*Mass customization:  
Reconfigurable  
Manufacturing System*  
1 PhD + 1 ongoing PhD (1 journal)

*Operational efficiency:  
lean manufacturing*  
1 PhD (2 journals)

*4.0 Information system: data  
connectivity to improve the  
productivity*  
2 PhD (1 journal)

### Current partnerships:

- Research activities with Coimbra and Karlsruhe
- Academic activities with industrial partners



**PhD subject : A decision aid system based on a decentralized architecture to faster the management of hazards occurring under production and logistics systems**

*“Hybridization of PEM hydrogen fuel cell and supercapacitors for maritime applications”*

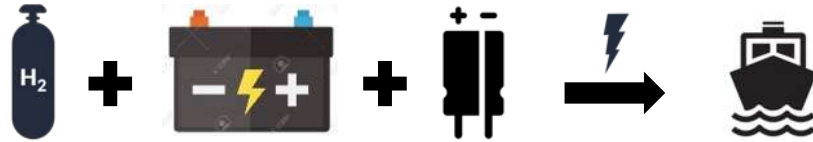

Objectives and scientific challenges :

- Ensure the **autonomy of maritime transportation** and being able to respond to the energy demand (steady-state functioning + sudden peaks)
- Coupling of both **short-term** modelization of **supercapacitors**, **mid-term** modelization of **PEM Fuel Cell functioning**, as well as long-term **durability** of the PEM Fuel Cell
- Using **metaheuristic optimization methods** to find the best combinations of technology and physical parameters

Main skills :

- Hydrogen technologies knowledges
- Numerical electrical and chemical modeling
- Computational optimization method
- Energy Management system

Context :

- Global warming
- Impact of maritime activities
- Growing green hydrogen production

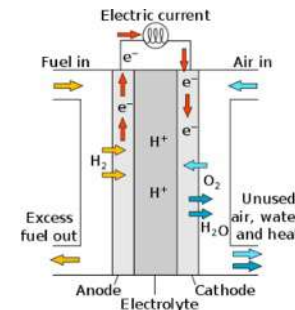
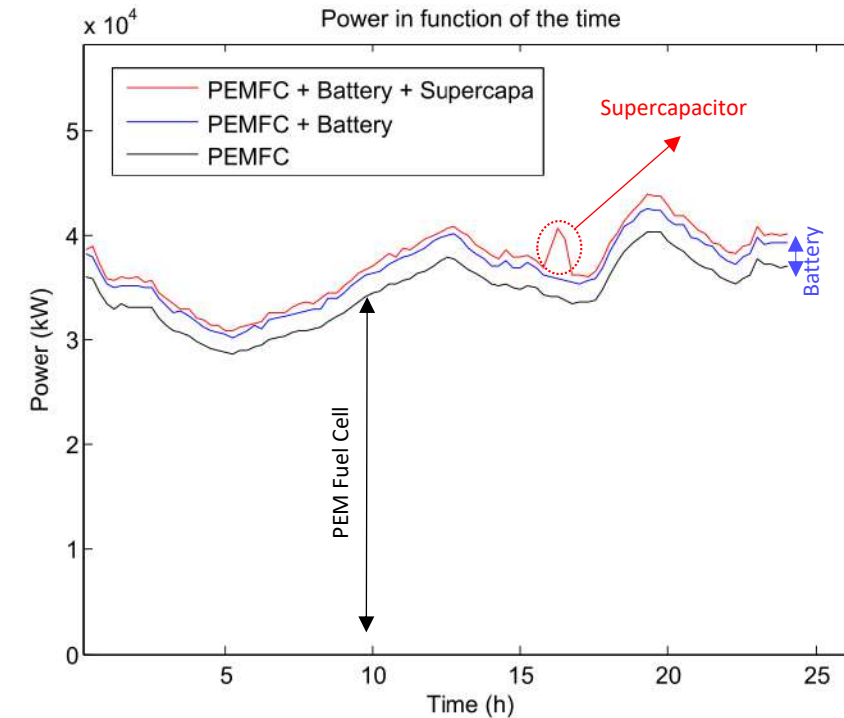



# ParisTech

#Connect

#Innovate

#Share

[www.paristech.fr](http://www.paristech.fr)





ParisTech



## **6. LABS AND PHD PROPOSALS**

ROOM 3 / MATERIAL SCIENCE, MECHANICS AND FLUIDS

# ROOM3 - Material science, Mechanics and Fluids PROPOSALS/LABS 1/3

File Number	School	Title	Advisors	Lab
2022_011	Arts et Métiers	Development of a high order model for Fluid-Structure interaction : application to soft solids	Mathieu Specklin, Sofiane Khelladi	LIFSE - Laboratoire Ingénierie des Fluides Systèmes Energétiques
2022_007	Arts et Métiers	Multiscale stress/strain analysis of polycrystalline silicon for photovoltaic applications	Laurent BARRALLIER	MSMP - Laboratoire Mécanique, Surface, matériaux et Procédés
2022_017	Arts et Métiers	Study of the microstructure, mechanical and fatigue properties of Ti-6Al-4V and Al-Co-Cr-Fe-Ni high entropy alloys components fabricated by wire-arc additive manufacturing	Laurent Barrallier, Mohamed Fares Slim	MSMP - Laboratoire Mécanique, Surface, matériaux et Procédés
2022_020	Arts et Métiers	Multiscale simulation of plastic strain localization in High Entropy Alloys	Dorian Depriester, Laurent Barrallier	MSMP - Laboratoire Mécanique, Surface, matériaux et Procédés
2022_022	Arts et Métiers	Optimized set-up to characterize the contact fatigue damage of material with gradient properties	Jean-Patrick Goulmy, Laurent Barrallier	MSMP - Laboratoire Mécanique, Surface, matériaux et Procédés
2022_023	Arts et Métiers	A smart manufacturing project: Digital Image Correlation characterization of residual stresses induced during the shot peening process	Jean-Patrick Goulmy, Laurent Barrallier	MSMP - Laboratoire Mécanique, Surface, matériaux et Procédés
2022_024	Arts et Métiers	Characterization of the evolution of mechanical properties of materials during in-situ SEM tests in temperature: implementation of the HRDIC technique	Jean-Patrick Goulmy, Laurent Barrallier	MSMP - Laboratoire Mécanique, Surface, matériaux et Procédés
2022_027	Arts et Métiers	Mechanical and functional fatigue behavior of laser powder bed fusion processed NiTi Shape Memory Alloy	Mohamed EL Mansori, Nan KANG, Tianyu YU	MSMP - Laboratoire Mécanique, Surface, matériaux et Procédés
2022_028	Arts et Métiers	Investigation on microstructure and strengthen mechanism of laser powder bed fusion high temperature multi-reinforced Al matrix composite	Nan KANG, Mohamed El Mansori, Biao CHEN	MSMP - Laboratoire Mécanique, Surface, matériaux et Procédés
2022_042	Ecole des Ponts ParisTech	Stability of dikes built with lime-treated soils under marine loading	Yujun CUI	Laboratoire NAVIER (mécanique, physique des matériaux et des structures, géotechnique)
2022_068	Ecole des Ponts ParisTech	Hydromechanical behavior of compacted sand-bentonite mixture under hydraulic, gas and chemical loadings	Yujun Cui, Nadia Mokni	Laboratoire NAVIER (mécanique, physique des matériaux et des structures, géotechnique)
2022_025	Arts et Métiers	Study of the low frequency dynamics of compressible separations	Jean-Christophe ROBINET, Ismaïl BEN HASSAN SAÏDI, Christian TENAUD	DynFluid
2022_085	Arts et Métiers	Finite elements analysis for optimum peeling conditions and higher veneer quality: Case of the rotary peeling process of European wood species	Louis Denaud, Mariem Yaich, Stéphane Girardon	LABOMAP - Laboratoire Bourguignon des matériaux et procédés
2022_032	Arts et Métiers	Dynamic crack propagation in multidirectional functionally graded materials under mechanical and thermal loadings	Amine Ammar, Mohammad-Javad KAZEMZADEHPARSI, Saber EL AREM	LAMPA - Laboratoire angevin de mécanique, procédés et innovation
2022_054	Arts et Métiers	PGD solution of beam, plate and shell structures made of functionally graded materials in thermal environment	Amine AMMAR, Mohammadjavad Kazemzadeh-Parsi	LAMPA - Laboratoire angevin de mécanique, procédés et innovation

# ROOM3 - Material science, Mechanics and Fluids PROPOSALS/LABS 2/3

File Number	School	Title	Advisors	Lab
2022_086	Arts et Métiers	Seismic cycle characteristics and dependence on rock rheology and friction	Amine AMMAR, saber EL AREM, Soumaya Latour	LAMPA - Laboratoire angevin de mécanique, procédés et innovation
2022_057	Arts et Métiers	Multi-physical/multi-scale modelling and experimental analysis of surface integrity in machining of Inconel 718 alloy using advanced cutting tools materials	Hélène Birembaux, José OUTEIRO, Frédéric ROSSI	LABOMAP - Laboratoire Bourguignon des matériaux et procédés
2022_016	ESPCI Paris - PSL	Active Colloidal Gels	Olivier Dauchot	GULLIVER - Voyages expérimentaux et théoriques en matière molle
2022_038	ESPCI Paris - PSL	Dynamical soft hydraulics of complex fluids	Joshua MCGRAW, Frédéric Restagno	GULLIVER - Voyages expérimentaux et théoriques en matière molle
2022_039	ESPCI Paris - PSL	Diffusive and hydrodynamic motion near soft and porous media	Joshua MCGRAW, Thomas SALEZ	GULLIVER - Voyages expérimentaux et théoriques en matière molle
2022_090	ESPCI Paris - PSL	Violation of Bell's inequalities in softmatter systems	Matthieu Labousse	GULLIVER - Voyages expérimentaux et théoriques en matière molle
2022_075	Arts et Métiers	Direct Numerical Simulation (DNS) of oil/water flows representative of oil spills	Olivier Coutier-Delgosha, Annie-Claude Bayeul-Lainé, Sophie Simonet	LMFL - Laboratoire de mécanique des fluides de Lille
2022_076	Arts et Métiers	Direct Numerical Simulation (DNS) of bubble bursting	Olivier Coutier-Delgosha, Annie-Claude Bayeul-Lainé, Sophie Simonet	LMFL - Laboratoire de mécanique des fluides de Lille
2022_031	Arts et Métiers	Elastic Turbulence in Curvilinear Geometries	Antoine DAZIN, Francesco ROMANO, Stefano BERTI	LMFL - Laboratoire de mécanique des fluides de Lille
2022_040	Arts et Métiers	Instabilities in the vaneless diffuser of a centrifugal pump	Antoine DAZIN, Francesco ROMANO, Gérard BOIS	LMFL - Laboratoire de mécanique des fluides de Lille
2022_015	ESPCI Paris - PSL	Aerodynamic and Elastic Response of Dragonfly-inspired Flapping Wings	Ramiro Godoy-Diana, Benjamin Thiria	PMMH - Physique et mécanique des Milieux Hétérogènes

# ROOM3 - Material science, Mechanics and Fluids PROPOSALS/LABS 3/3

File Number	School	Title	Advisors	Lab
2022_026	Arts et Métiers	Experimental and numerical study of the forgeability of a Wire Arc Additive Manufactured (WAAM) preform, Application to large multi-material parts	Régis Bigot, Laurent Langlois, Sandra Zimmer-Chevret	LCFC - Laboratoire de conception, fabrication, commande
2022_029	Arts et Métiers	Multi-scale data-driven modelling of short-fibre reinforced composites for automotive applications	Fodil Meraghni, Francis Praud	LEM3 - Laboratoire d'étude des microstructures et de mécanique des matériaux
2022_033	ESPCI Paris - PSL	Bio-inspired flexible plates for surface wave energy conversion	Ramiro Godoy-Diana, Benjamin Thiria	PMMH - Physique et mécanique des Milieux Hétérogènes
2022_034	Arts et Métiers	Towards digital twins for the optimization of the copper based shape memory alloys with high entropy	Fodil MERAGHNI, Léo THIERCELIN, Laurent PELTIER	LEM3 - Laboratoire d'étude des microstructures et de mécanique des matériaux
2022_035	Arts et Métiers	Development of advanced multiscale computational tools and data-driven techniques for the multiphysics prediction of carbon nanotubes (CNTs) fuzzy fiber composites	George Chatzigeorgiou, Fodil Meraghni	LEM3 - Laboratoire d'étude des microstructures et de mécanique des matériaux
2022_066	Chimie ParisTech - PSL	Deformation mechanisms study of TWIP and TRIP metastable titanium alloy	Philippe Vermaut, Fan SUN	IRCP - Institut de Recherche de Chimie de Paris
2022_072	Arts et Métiers	Very-high-cycle fatigue strength of metals under multiaxial stress state	Thierry PALIN-LUC, Matthieu BONNERIC, Youshi HONG, Guian QIAN	I2M - Institut de mécanique et d'ingénierie
2022_083	Arts et Métiers	Integrated Human-Machine interface for automation of a flexible and agile grinding process of forged workpieces with industrial robots	Régis BIGOT, Cyrille BAUDOUIN, Sandra CHEVRET	LCFC - Laboratoire de conception, fabrication, commande
2022_084	Arts et Métiers	Robust robotic grinding: process identification and improvement of the control	Régis BIGOT, Thibaut Raharijaona, Sandra CHEVRET	LCFC - Laboratoire de conception, fabrication, commande
2022_094	Arts et Métiers	Efficient computational framework to model size effects in miniaturized products	Farid Abed-Meraim, Mohamed Jebahi	LEM3 - Laboratoire d'étude des microstructures et de mécanique des matériaux
2022_079	Ecole des Ponts ParisTech	Automatic Capture of Visual Data for Digital Twins of Worksites	Vincent Lepetit, Chaohui Wang	LIGM - Laboratoire d'Informatique Gaspard Monge
2022_067	ESPCI Paris - PSL	Using good vibrations to decrease the viscosity of non brownian suspensions	Annie COLIN , Jia Xiaoping , Arnaud Tourin	CBI - Chimie, Biologie et Innovation

# ParisTech

#Connect

#Innovate

#Share

[www.paristech.fr](http://www.paristech.fr)



# PARISTECH – CSC PHD PROGRAM

ParisTech  
#Connect #Innovate #Share

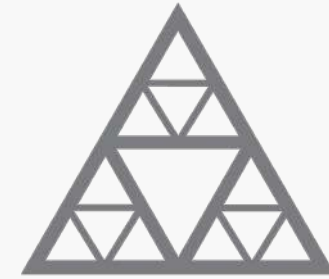

École des Ponts  
ParisTech

NAVIER LABORATORY

Navier

### Équipe Administrative

Resp.: V. Frey





Sabrina Chartier Marie-Françoise Kaspi Ninon Lambré Céline Reter

### Équipe Technique Transversale

Resp.: O. Pitois





Christophe Courrier Cédric Mézière Pascal Moucheron

### Équipe Technique 1

Resp.: Y.-J. Cui







Xavier Boulay Baptiste Chabot Aurore Horabik Marine Lemaire Loïc Lesueur

### Équipe Technique 2

Resp.: G. Foret





Christophe Bernard Hocine Delmi Gilles Moreau

### Direction

Directeur



Jean Sulem

Directeur adjoint



Jean-Michel Pereira

Secrétaire générale



Virginia Frey

Directeur adjoint



Jean-Noël Roux



### Support Pédagogique et Informatique



Sébastien Gervillers

### Équipe Technique 3

Resp.: M. Bornert





Patrick Almedieu Julien Archez Géraldine Vue

### Équipe Technique 4

Resp.: O. Pitois





Patrick Belin Jaime-Elias Gil Roca Benjamin Maillet Laurent Toquer



### Géotechnique

Responsable



Yu-Jun Cui

Chercheur émerite





Philipp Braun Jean Canou Alain Corfdir Patrick Dangla





Pierre Delage Jean-Claude Dupla Roger Frank Siavash Ghabezloo





Lina Maria Guayacan Carillo Mathias Lebihain Jean-Michel Pereira Amade Pouya



Jean Sulem Anh-Minh Tang

### Matériaux et structures architecturés

Responsable



Jean-François Caron

Adjoint



Gilles Foret





Olivier Baverel Karim Benzarti Jérémy Bleyer Sabine Caré





Cyrille Douthe Denis Duhamel Adelaïde Féraïlle Tien Hoang





Arthur Lebé Robert Le Roy Romain Mesnil Michael Peigney





Myriam Saadé Karam Sab Honoré Yin

### Multi-échelle

Responsable



Michel Bornert

Adjoint



Denis Garnier

Chercheur émerite





Sébastien Brisard Laurent Brochard Patrick De Buhau Camille Chateau





Gwendal Cumunel Luc Dormieux Ghazi Hassen Emmanuel Keita





Mathias Lebihain Frédéric Legoll Eric Lemarchand Matthieu Vandamme

### Rhéophysique et milieux poreux

Responsable



Olivier Pitois

Adjointe



Florence Rouyer





Xavier Chateau François Chevoir Philippe Coussot Abdoulaye Fall





Julie Goyon Yacine Khidas Vincent Langlois Anaël Lemaître







Julien Léopoldès Francesco Puosi Nicolas Roussel Jean-Noël Roux



Éric Saint-Michel Rahima Sidi-Boulenouar

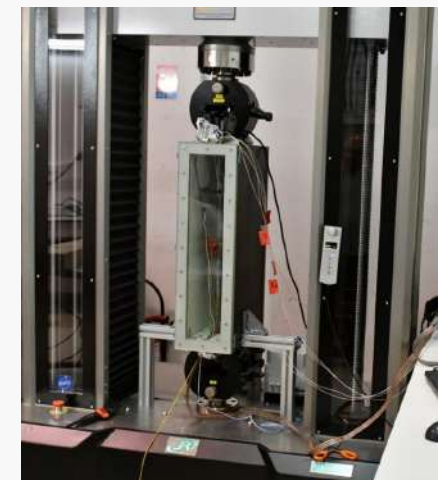
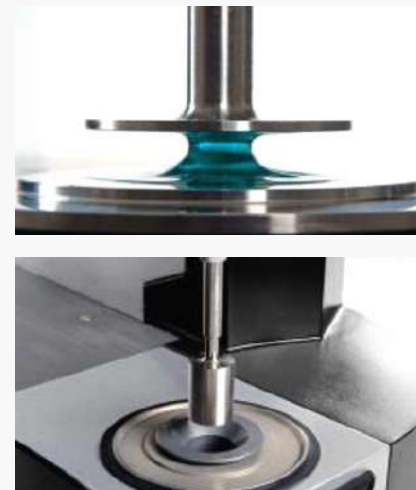
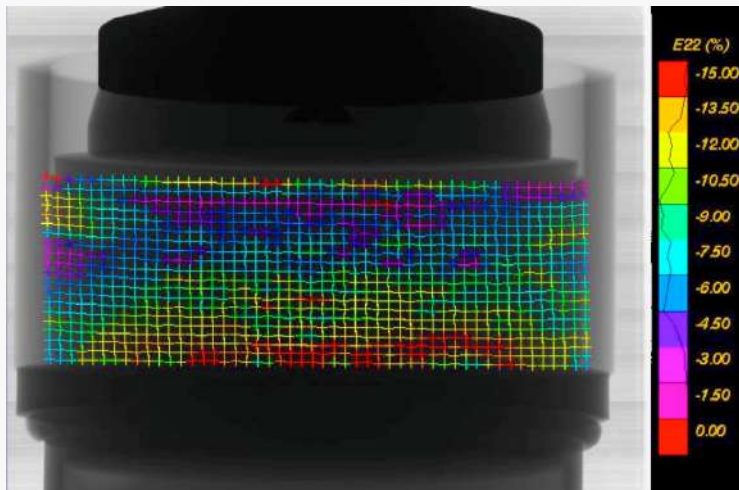
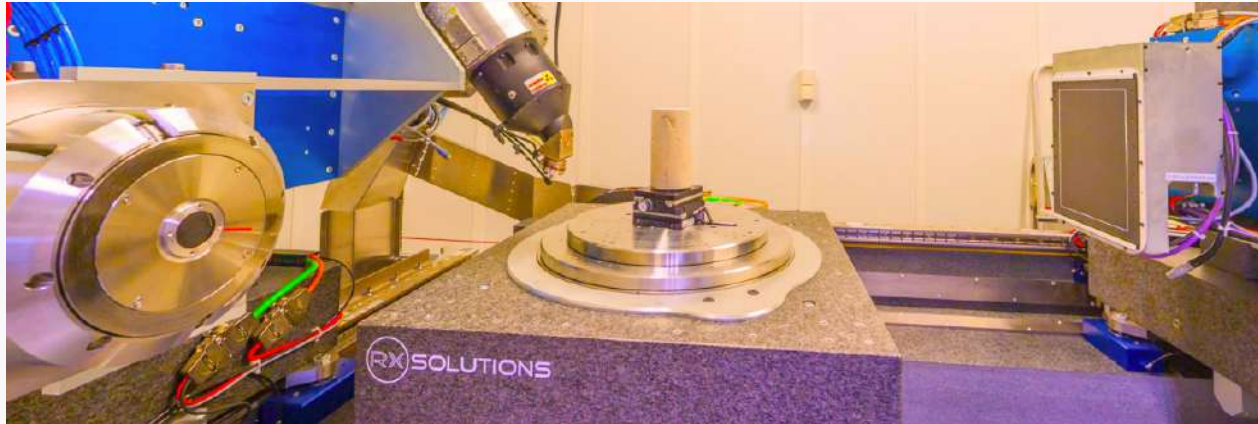

## RESEARCH INFRASTRUCTURES



**Geotechnic (CERMES) research team**

Research axis:  
Unsaturated soils  
Storage of radioactive waste  
Railway geotechnics  
Soil-atmosphere interaction

Yu Jun CUI  
*Researcher*  
*Professor at Ecole des Ponts ParisTech*



PhD title 1: Stability of dikes built with lime-treated soils under marine loading

PhD title 2: Hydromechanical behavior of compacted sand-bentonite mixture under hydraulic, gas and chemical loadings

A 3<sup>rd</sup> PhD proposed by my colleagues of ENPC: Vincent Lepetit, Chaohui Wang  
in the field of Information and Communication Science and Technology

PhD title 3: Automatic Capture of Visual Data for Digital Twins of Worksites

# ParisTech

#Connect

#Innovate

#Share

[www.paristech.fr](http://www.paristech.fr)



ParisTech  
#Connect #Innovate #Share



LABORATOIRE DE MÉCANIQUE DES FLUIDES DE LILLE

ARTS ET MÉTIERS, CAMPUS OF LILLE



Research domain(s): Turbulence, Rotating Flows, Flight Dynamics in Unsteady and Non Uniform Environments

Turbulence:  
study and model turbulent flows

Team leader

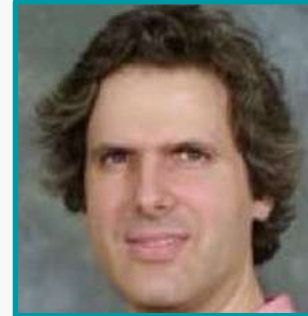

Christos VASSILICOS

Rotating Flows:  
analysis and modeling of internal or  
external flows linked to rotating machines

Team leader



Antoine DAZIN

Flight Dynamics:  
development of tools and methods to  
determine dynamics of aircrafts flying

Team leader



Olivier RENIER

**RESEARCH INFRASTRUCTURES**

***Rotating Flows, Turbulence, Flight Dynamics***

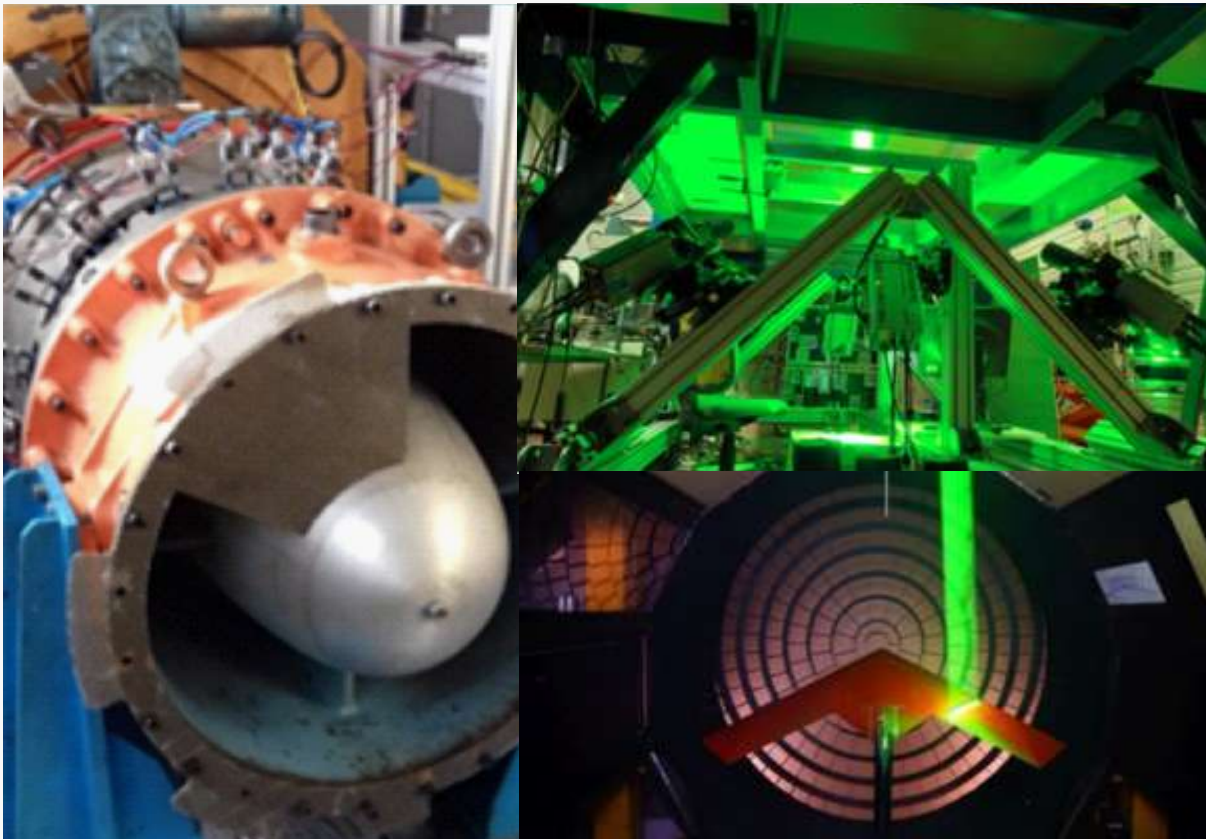

**KEY RESEARCHER (S)**



CHRISTOS VASSILICOS /  
*h index 50*



JEAN-PHILIPPE LAVAL /  
*h index 21*

## KEY FACTS / FIGURES



37 permanent people (researchers, research professors, engineers and technicians) and 25 non-permanent researchers (doctoral students and post-doctocs).



Partnerships with academic laboratories (universities, research organizations), companies (logos)



20 publications in high-impact international journals during 2022

List of publications:

[https://lmfl.cnrs.fr/en/articles\\_en/](https://lmfl.cnrs.fr/en/articles_en/)



LMFL is a member of EUHITT : Euopean Consortium that aims at integrating cutting-edge European facilities for turbulence research

**European Project ACONIT** : Design and test high level actuators for flow control in aeronautical compressors. <https://aconit.ensam.eu/>

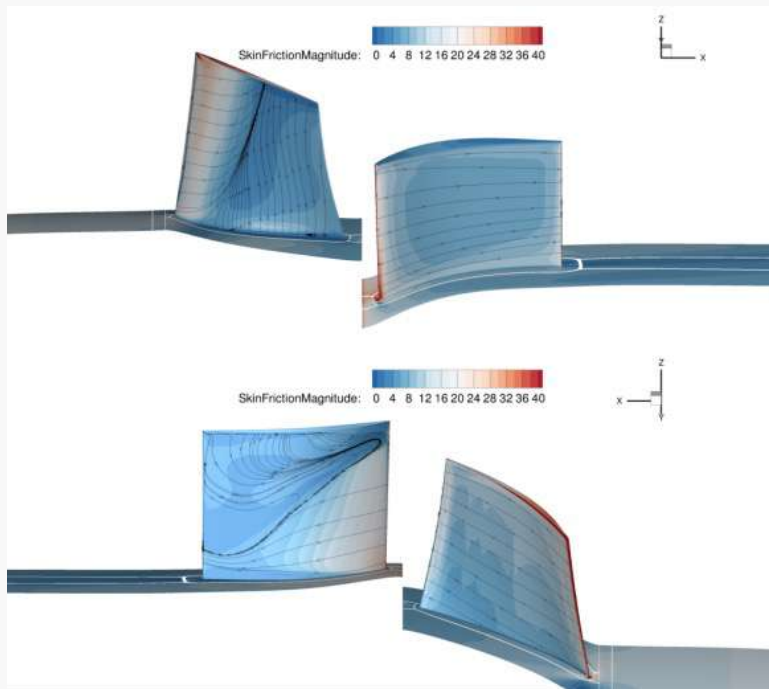

CFD in an axial compressor

**ANR Project EXPLOIT** : Experimental study of dissipative structures in Turbulence.

<https://lmfl.cnrs.fr/actualite/campagne-de-mesure-4d-ptv-dans-le-projet-anr-exploit/>

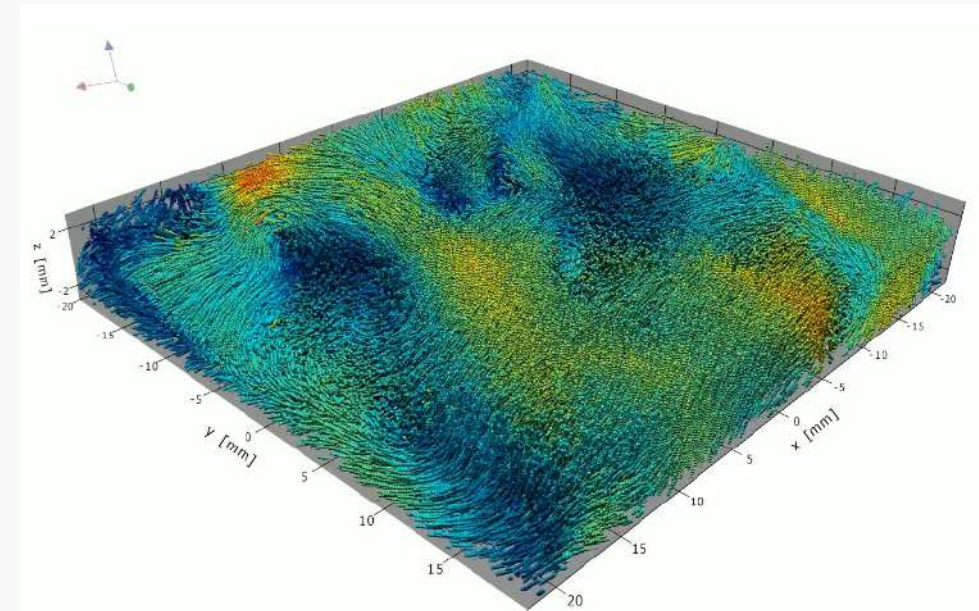

High speed, high resolution PTV results of a turbulent flow



# ParisTech

#Connect

#Innovate

#Share

[www.paristech.fr](http://www.paristech.fr)



# Direct Numerical Simulation (DNS) of oil/water flows representative of oil spills

**Objective:** investigate the interaction between the sea water and the oil slicks and how the oil is mixed with the water and the atmosphere (creation of aerosols)

Layer of oil

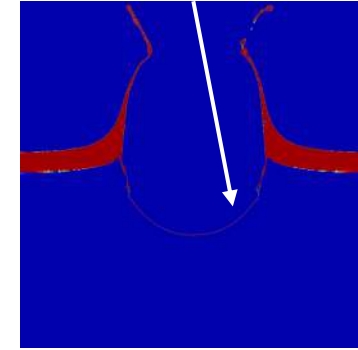

**Simulation of the impact of a droplet at the surface of water**

## Simulation of a breaking wave

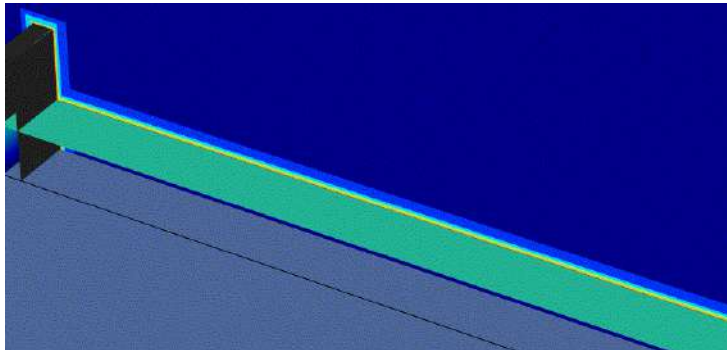

total of 230,000 core hours

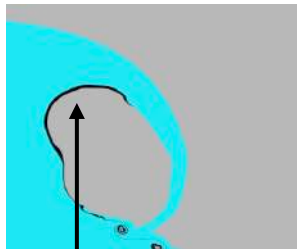

oil slick at impact

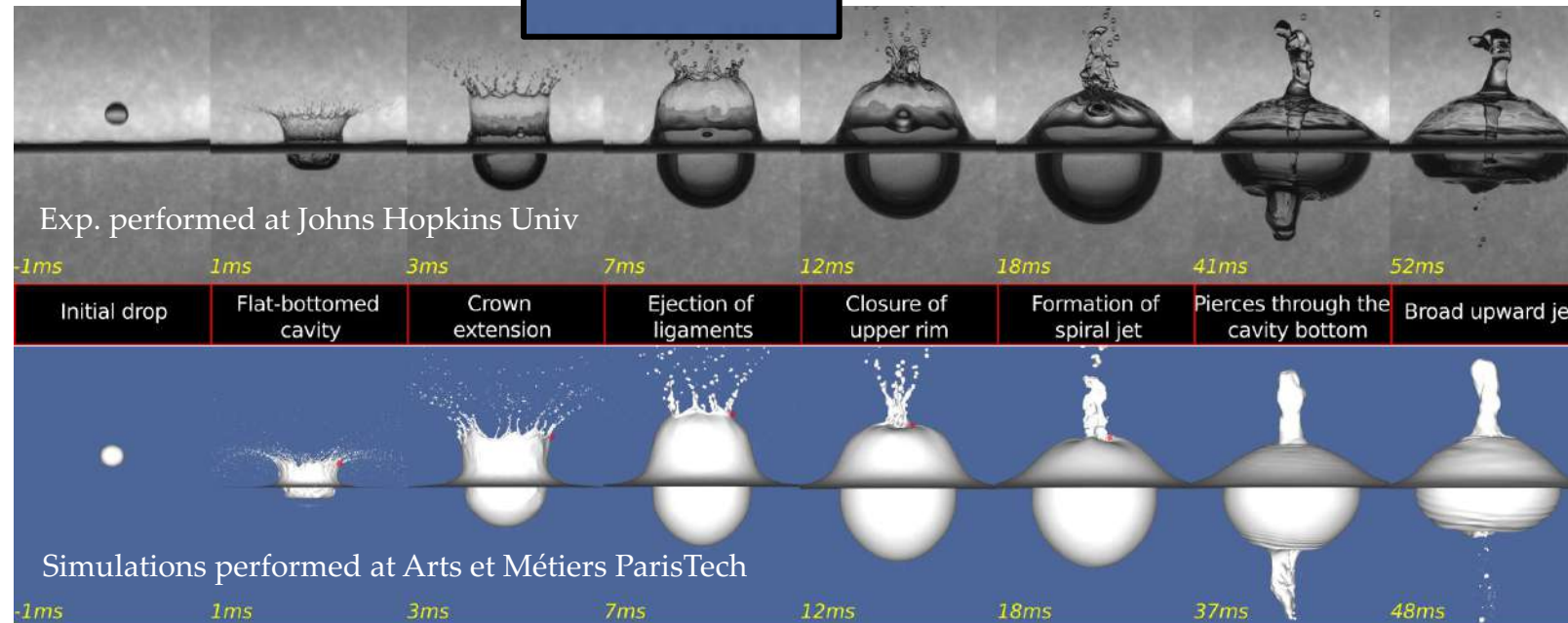

Maximum number of cells more than  $6.5 \times 10^7$ , performed on 1024 cores for 33.5 days ( $8.21 \times 10^5$  CPU-hour), Advanced Research Computing(ARC), Virginia Tech

## Direct Numerical Simulation (DNS) of Bubble Bursting

**Objective:** investigate by Direct Numerical Simulation (DNS) the gas jet released by bubbles bursting at the air-sea interface and the capacity of this flow to transport newly formed film droplets up into the atmosphere.

**Tool:** BASILISK code to solve **multiphase and/or multicomponents flows** by using the Volume of Fluid (VoF) technique

Adaptive Mesh Refinement (AMR)

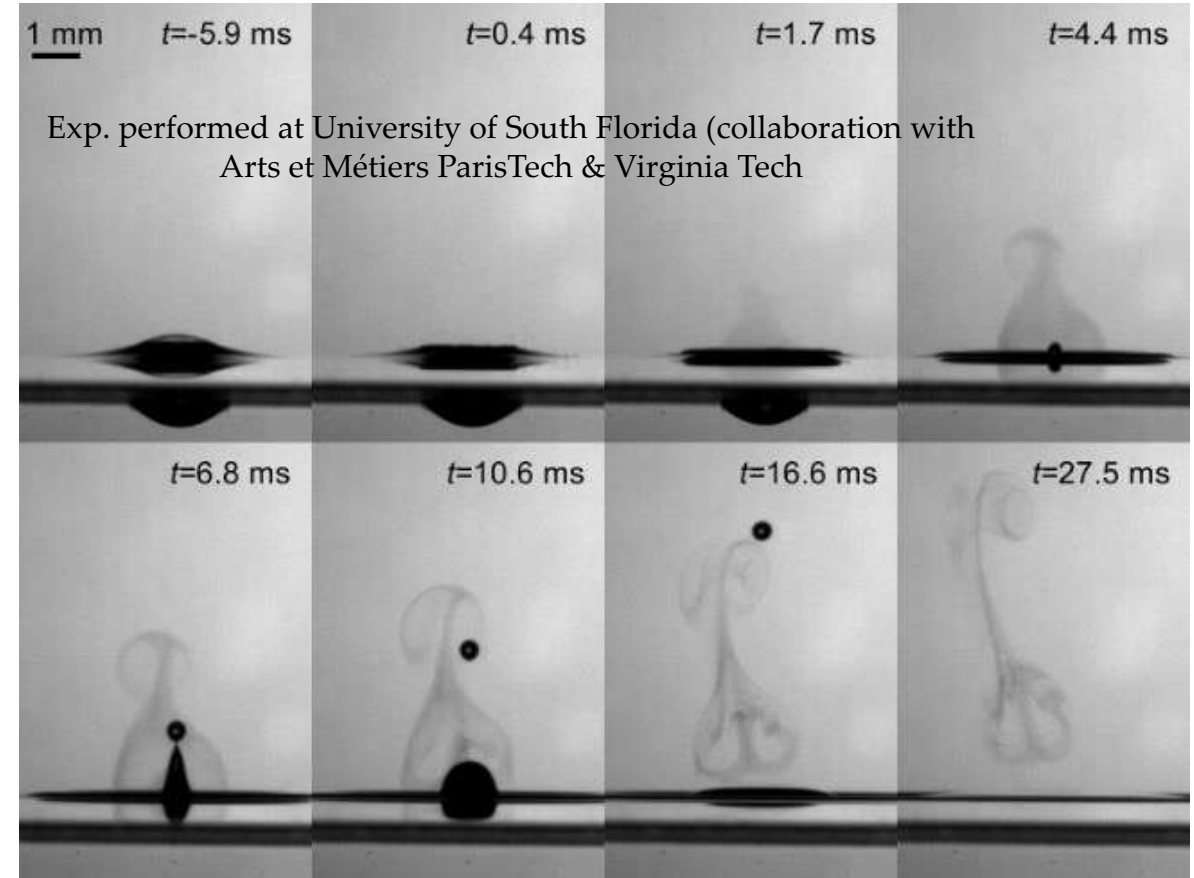
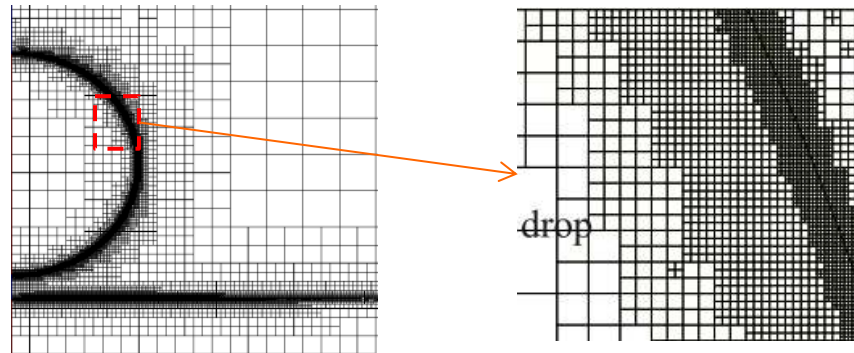
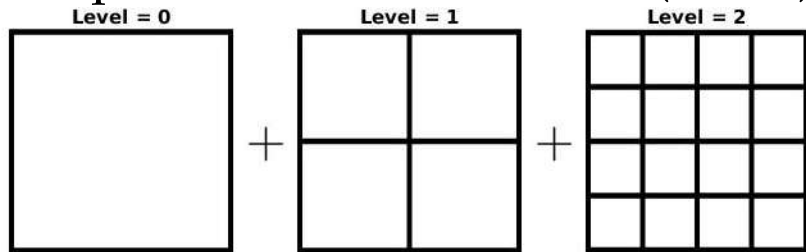

Shuo Liu, Hui Wang, Annie-Claude Bayeul-Lainé, Olivier Coutier-Delgosha (2022), [Direct Numerical Simulation of Shallow Water Breaking Waves Generated by Wave Plate](#), Conference on Modelling Fluid Flow CMFF'22, pp 206-214.

# ParisTech

#Connect

#Innovate

#Share

[www.paristech.fr](http://www.paristech.fr)



# PARISTECH – CSC PHD PROGRAM

ParisTech  
#Connect #Innovate #Share



ParisTech  
#Cooperate #Innovate #Share



École des Ponts  
ParisTech

**NAVIER LABORATORY**

Navier

### Équipe Administrative

Resp.: V. Frey





Sabrina Chartier Marie-Françoise Kaspi Ninon Lambré Céline Reter

### Équipe Technique Transversale

Resp.: O. Pitois





Christophe Courrier Cédric Mézière Pascal Moucheron

### Équipe Technique 1

Resp.: Y.-J. Cui







Xavier Boulay Baptiste Chabot Aurore Horabik Marine Lemaire Loïc Lesueur

### Équipe Technique 2

Resp.: G. Foret





Christophe Bernard Hocine Delmi Gilles Moreau

### Direction

Directeur



Jean Sulem

Directeur adjoint



Jean-Michel Pereira

Secrétaire générale



Virginia Frey

Directeur adjoint



Jean-Noël Roux



### Support Pédagogique et Informatique



Sébastien Gervillers

### Équipe Technique 3

Resp.: M. Bornert





Patrick Almedieu Julien Archez Géraldine Vue

### Équipe Technique 4

Resp.: O. Pitois





Patrick Belin Jaime-Elias Gil Roca Benjamin Maillet Laurent Toquer

### Géotechnique

Responsable



Yu-Jun Cui

Chercheur émerite





Philipp Braun Jean Canou Alain Corfdir Patrick Dangla





Pierre Delage Jean-Claude Dupla Roger Frank Siavash Ghabezloo





Lina Maria Guayacan Carillo Mathias Lebihain Jean-Michel Pereira Amade Pouya



Jean Sulem Anh-Minh Tang

### Matériaux et structures architecturés

Responsable



Jean-François Caron

Adjoint



Gilles Foret





Olivier Baverel Karim Benzarti Jérémy Bleyer Sabine Caré





Cyrille Douthe Denis Duhamel Adelaïde Féraïlle Tien Hoang





Arthur Lebé Robert Le Roy Romain Mesnil Michael Peigney





Myriam Saadé Karam Sab Honoré Yin

### Multi-échelle

Responsable



Michel Bornert

Adjoint



Denis Garnier

Chercheur émérite





Sébastien Brisard Laurent Brochard Patrick De Buhau Camille Chateau





Gwendal Cumunel Luc Dormieux Ghazi Hassen Emmanuel Keita





Mathias Lebihain Frédéric Legoll Eric Lemarchand Matthieu Vandamme

### Rhéophysique et milieux poreux

Responsable



Olivier Pitois

Adjointe



Florence Rouyer





Xavier Chateau François Chevoir Philippe Coussot Abdoulaye Fall





Julie Goyon Yacine Khidas Vincent Langlois Anaël Lemaître







Julien Léopoldès Francesco Puosi Nicolas Roussel Jean-Noël Roux

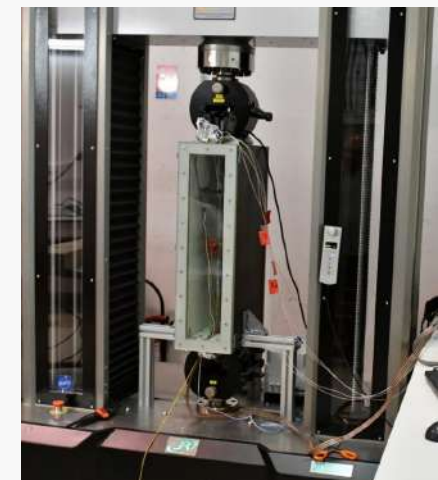
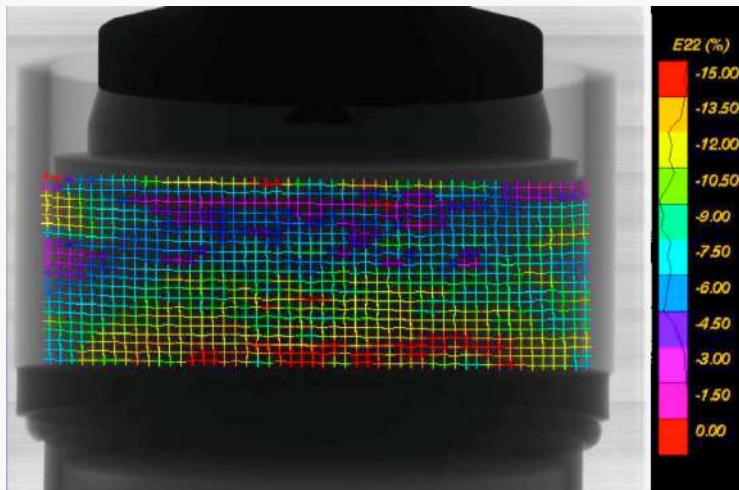
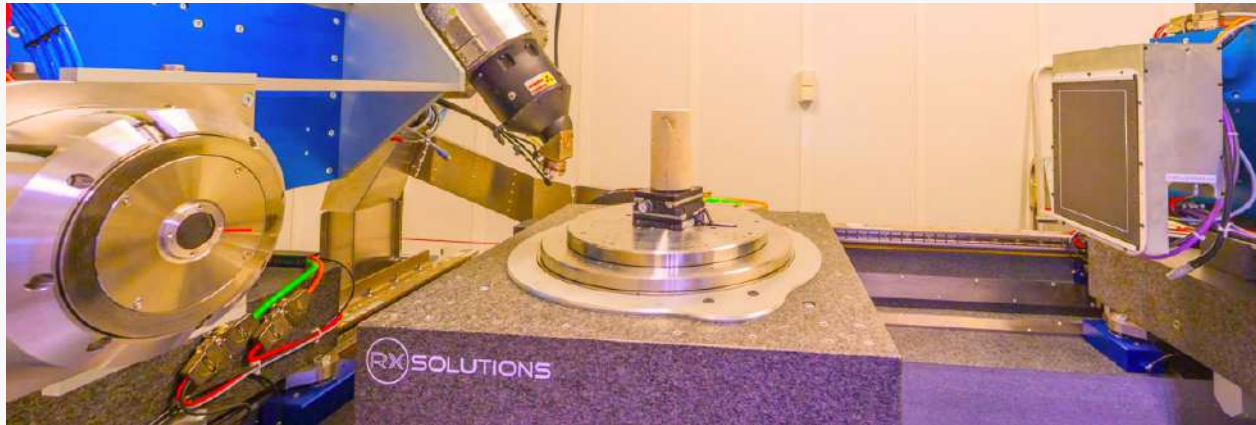

Éric Saint-Michel Rahima Sidi-Boulououar

## RESEARCH INFRASTRUCTURES



## Geotechnic (CERMES) research team

Research axis:

Unsaturated soils

Storage of radioactive waste

Railway geotechnics

Soil-atmosphere interaction

Yu Jun CUI

*Researcher*

*Professor at Ecole des Ponts ParisTech*



PhD title 1: Stability of dikes built with lime-treated soils under marine loading

PhD title 2: Hydromechanical behavior of compacted sand-bentonite mixture under hydraulic, gas and chemical loading

A 3<sup>rd</sup> PhD proposed by my colleagues of ENPC: Vincent Lepetit, Chaohui Wang in the field of Information and Communication Science and Technology

PhD title 3: Automatic Capture of Visual Data for Digital Twins of Worksites



# ParisTech

#Connect

#Innovate

#Share

[www.paristech.fr](http://www.paristech.fr)



in



f

ParisTech  
#Connect #Innovate #Share



ESPCI  PARIS | PSL 

LABORATOIRE GULLIVER / IPGG

UMR 7083  
Gulliver

 INSTITUT  
PIERRE-GILLES  
DE GENNES  
Pour la microfluidique

# Decades of soft matter at Gulliver

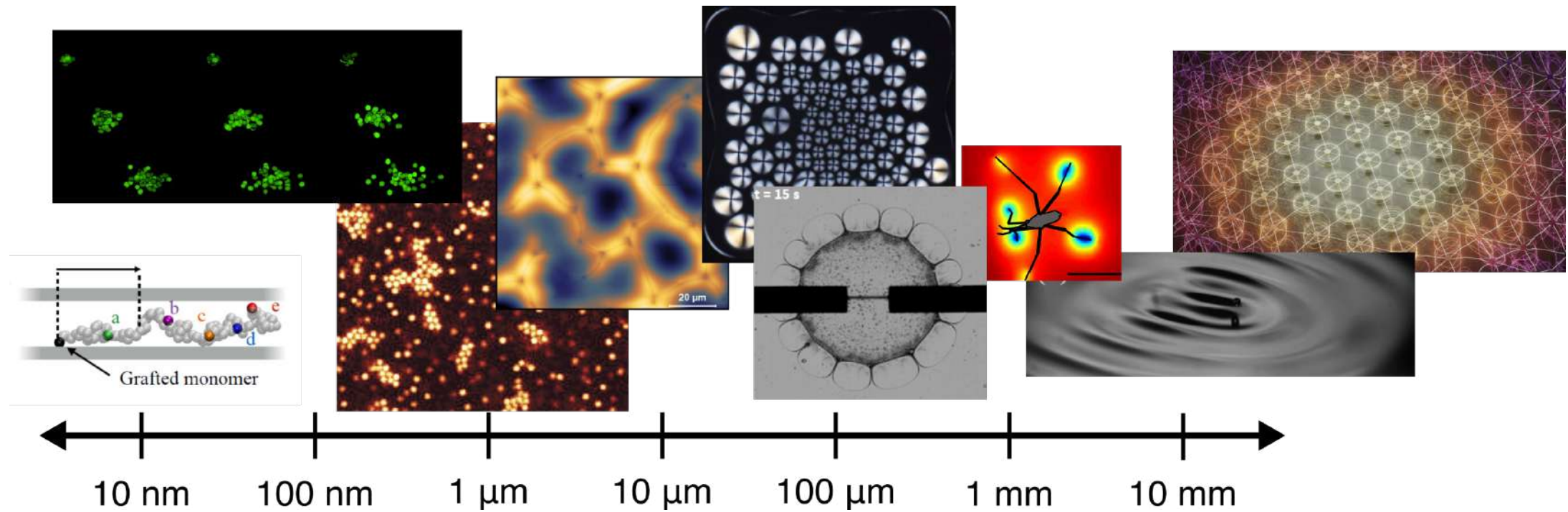

# Decades of soft matter at Gulliver

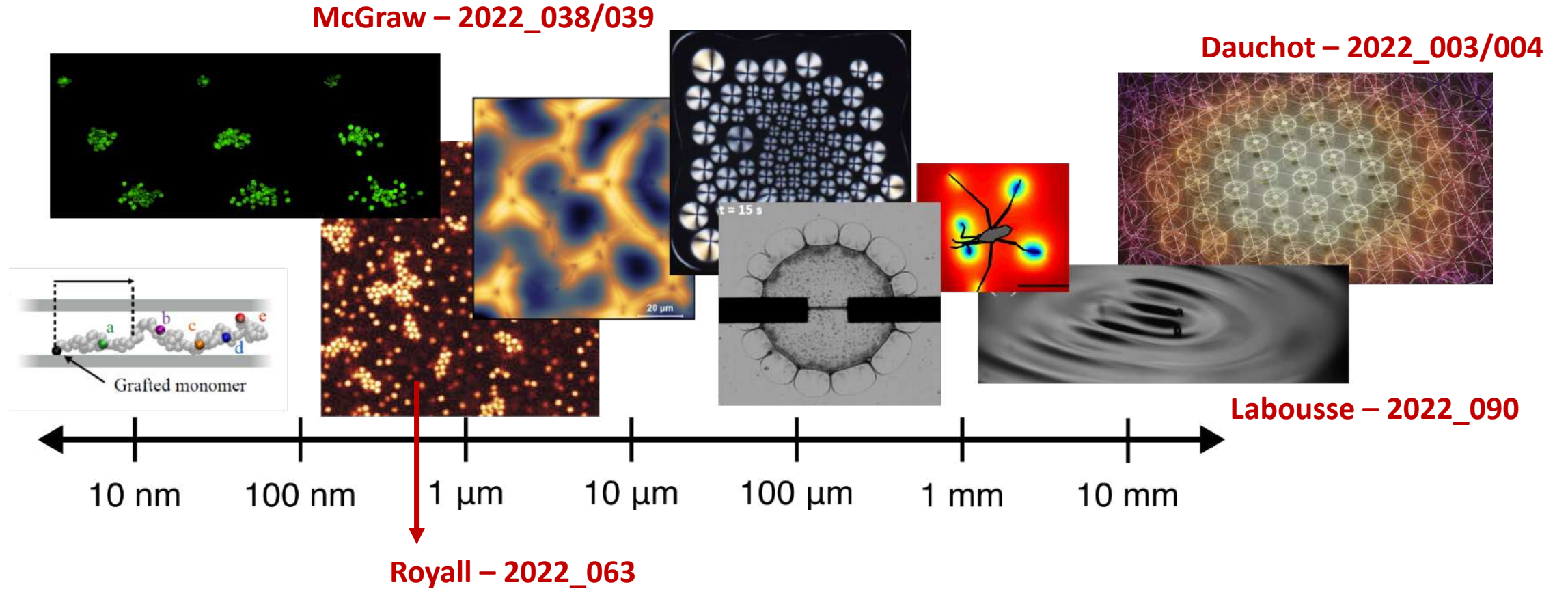

# IndySoft: Interfacial Dynamics of Soft Condensed Matter

Project: **2022\_038**

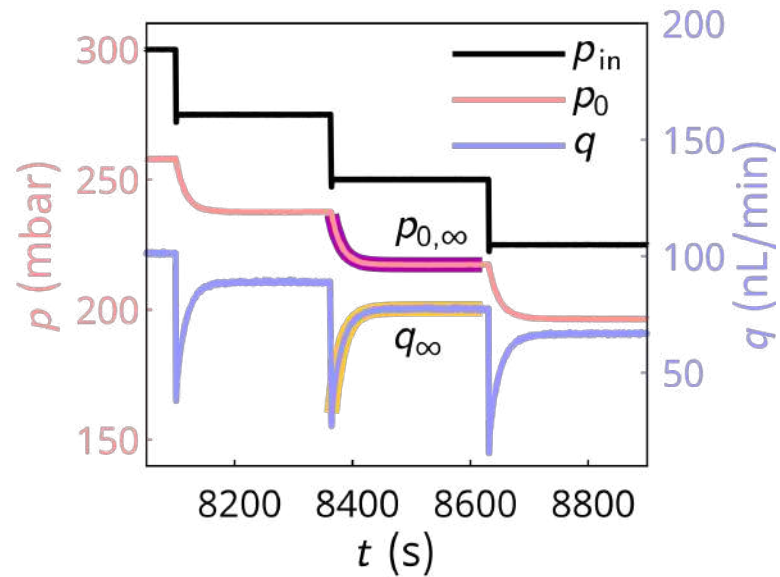
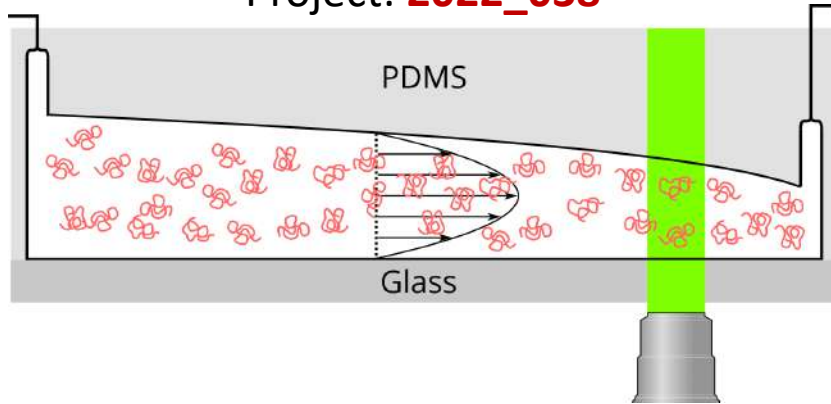

Guyard *et al.*,  
Soft Matter 2021; Phys. Rev. Lett. **2022**

Project: **2022\_039**

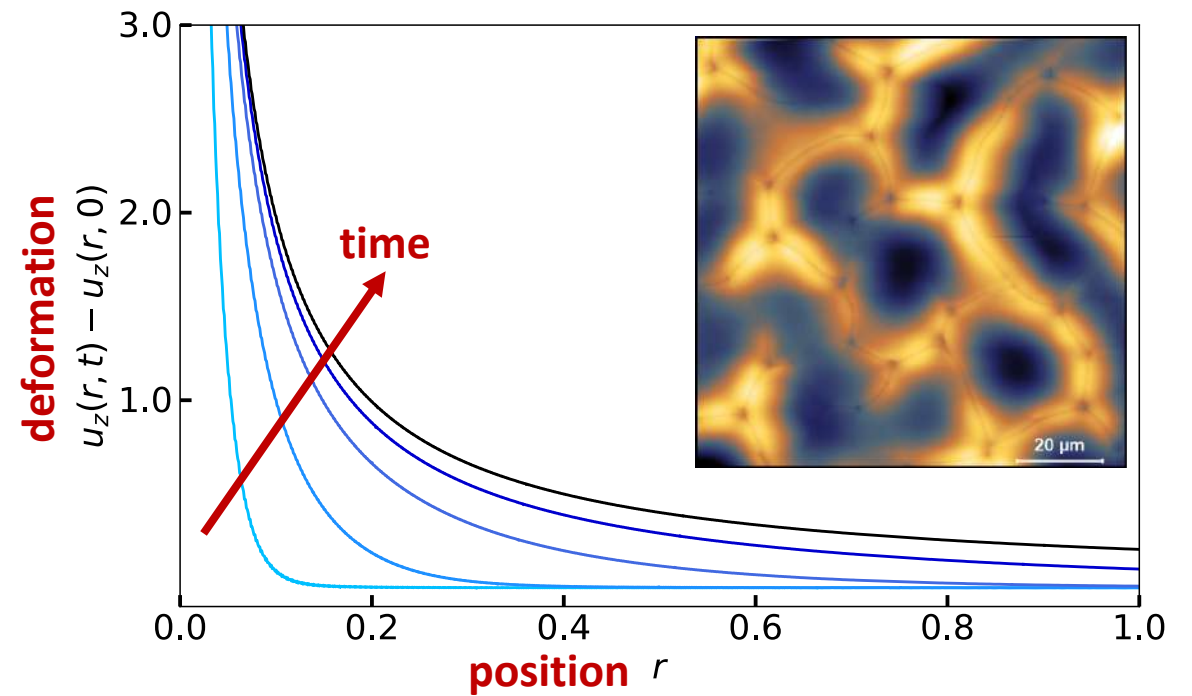
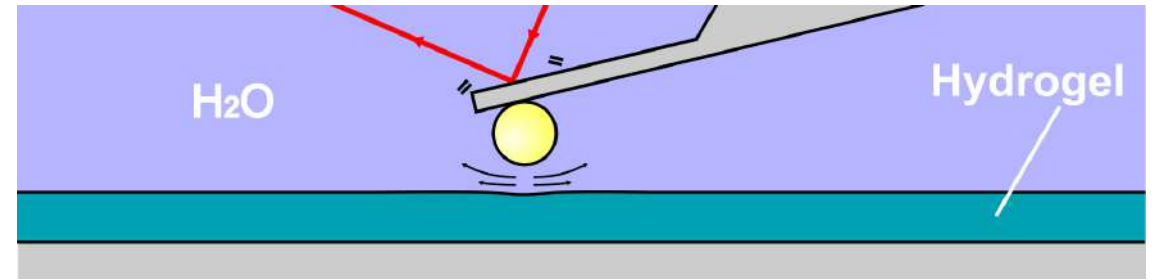

Kopecz-Muller *et al.* In prep.  
Zheng *et al.*, Phys. Rev. Research **2022**

# IndySoft @ Gulliver, ESPCI Paris - PSL

*Soft Matter at Interfaces : colloids, polymers, micro/nanofluidics*

**IndySoft:** Interfacial dynamics of Soft Matter

Advisor



Joshua D. McGraw

**MMOI:** Matière molle aux interfaces

Co-advisor (2022\_038)



Frédéric Restagno

**EMetBrown:** Brownian motion near soft interfaces

Co-advisor (2022\_039)



Laboratoire Ondes et Matière d'Aquitaine

Thomas Salez

# IndySoft: Interfacial Dynamics of Soft Condensed Matter

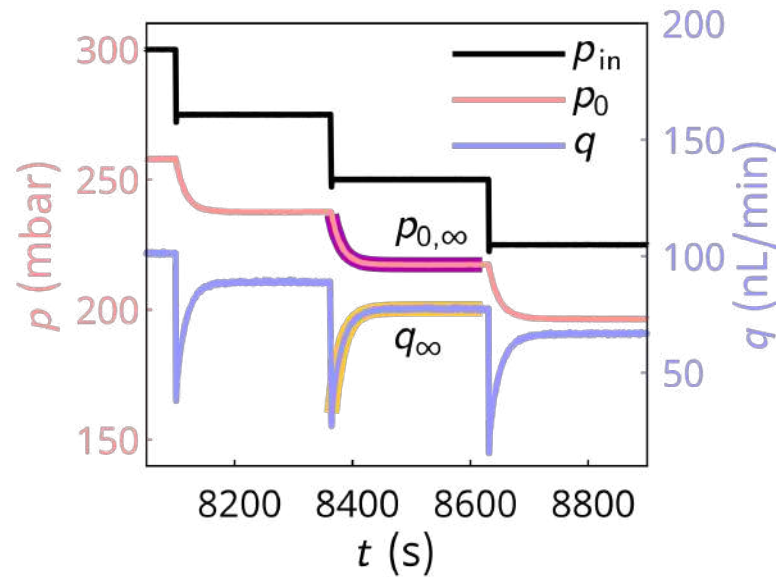
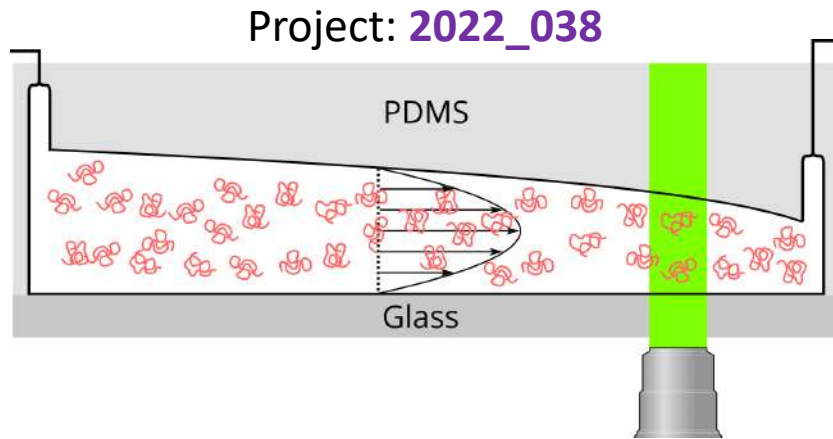

ParisTech  
#Connect #Innovate #Share

Guyard *et al.*,  
Soft Matter 2021; Phys. Rev. Lett. **2022**

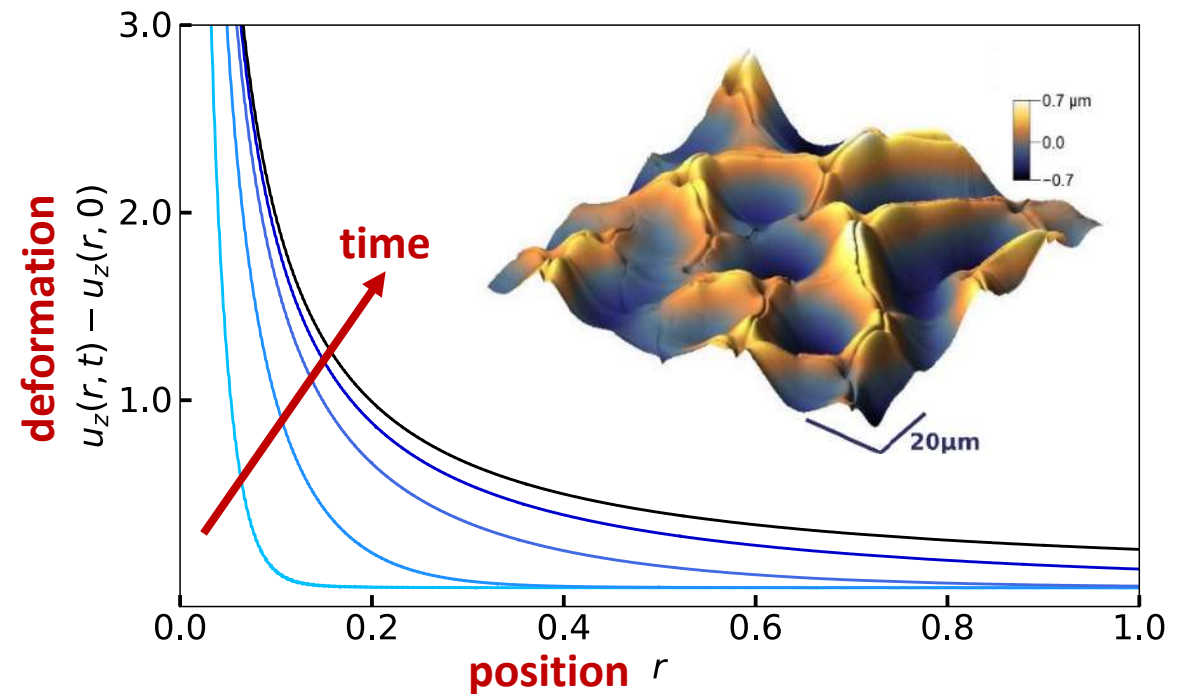
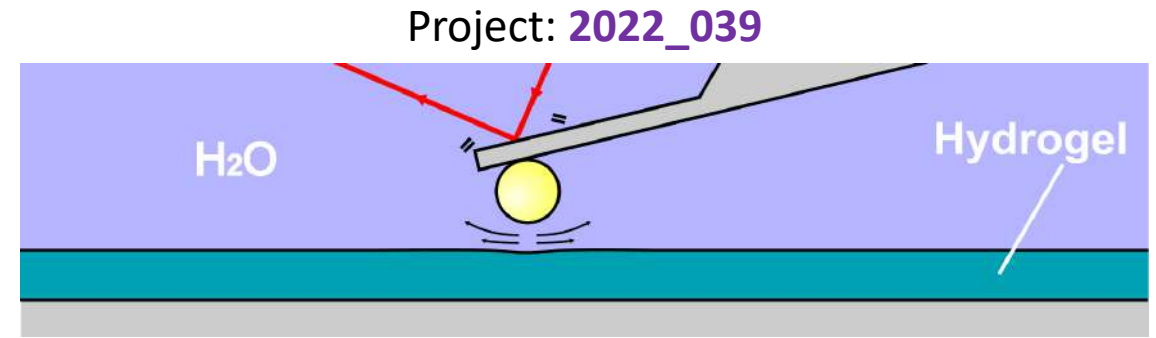

Kopecz-Muller *et al.* In prep.  
Zheng *et al.*, Phys. Rev. Research **2022**

# ParisTech

#Connect

#Innovate

#Share

[www.paristech.fr](http://www.paristech.fr)





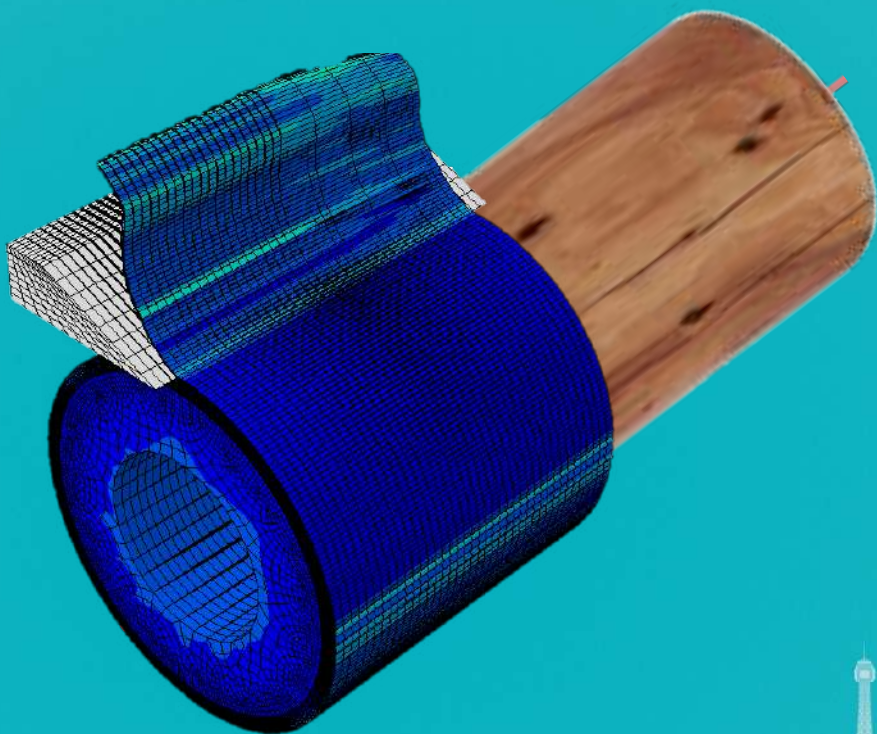

# Paristech – CSC PhD program

*FINITE ELEMENT ANALYSIS FOR OPTIMUM PEELING  
CONDITIONS AND HIGHER VENEER QUALITY  
(TOPIC NUMBER: **2022\_085**)*

Novembre 2022





PARISTECH



LABORATORY OF MATERIALS AND PROCESSES

DIRECTOR: PR. GERARD POULACHON



Research domains: Manufacturing processes, Materials, Thermomechanical treatments

**Wood Material Machining (WMM):**  
Wood machining, Mechanical properties of the wood, elaboration and characterization of engineered wood products

Team leader



Associate Pr-HDR.  
Louis DENAUD



**High Speed Machining (HSM):**  
Machining processes of difficult to cut materials, Generation of complexes surfaces

Team leader



Associate Pr-HDR.  
Guillaume FROMENTIN

**Materials and Surfaces Engineering (MSE) :**  
Improvement of mechanical properties of metals and alloys, Thermomechanical treatments and PVD coating

Team leader



Associate Pr-HDR.  
Corrine NOUVEU



## WOOD MATERIAL MACHINING (WMM) TEAM



**Rémy Marchal**  
Emeritus Pr.

**Robert Collet**  
Associate Pr. -HDR

**Louis Denaud**  
Associate Pr.-HDR

**Stéphane Girardon**  
Associate Pr.

**Guillaume Pot**  
Associate Pr.

**Joffrey Viguier**  
Associate Pr.

**Mariem Yaich**  
Associate Pr.



**Juliette Boivin**  
PhD Student

**Leyne Demoulin**  
PhD Student

**Lucie Heim**  
PhD Student

**Caroline Marc**  
PhD Student

**Hélène Penvern**  
PhD Student

**Xiaolin LI**  
Post-doctoral + Former CSC PhD Student



**Jean-Claude Butaud**  
Research Eng.

**Fabrice Cottin**  
Assistant Eng.

**Roger Letourneau**  
Technician

**Marie-Laure Louvrier**  
Management Assistante  
of LaBoMaP

**Pascal Filipek**  
Assistant Eng.

**Bertrand Marcon**  
Research Eng.



**Isabelle Bordonnet**  
Management  
Assistante of AMValor

**Benjamin Roux**  
AMValor Eng.

**Guillaume Lacondemine**  
AMValor Eng.

- 7 Associate Pr. / HDR / Pr.
- 2 Research Eng.
- 2 AMValor Eng.
- 2 Assistant Eng.
- 1 Technician
- 5 PhD students
- 1 Post-doctoral

## WMM RESEARCH INFRASTRUCTURES: PEELING & WOOD CHARACTERIZATION

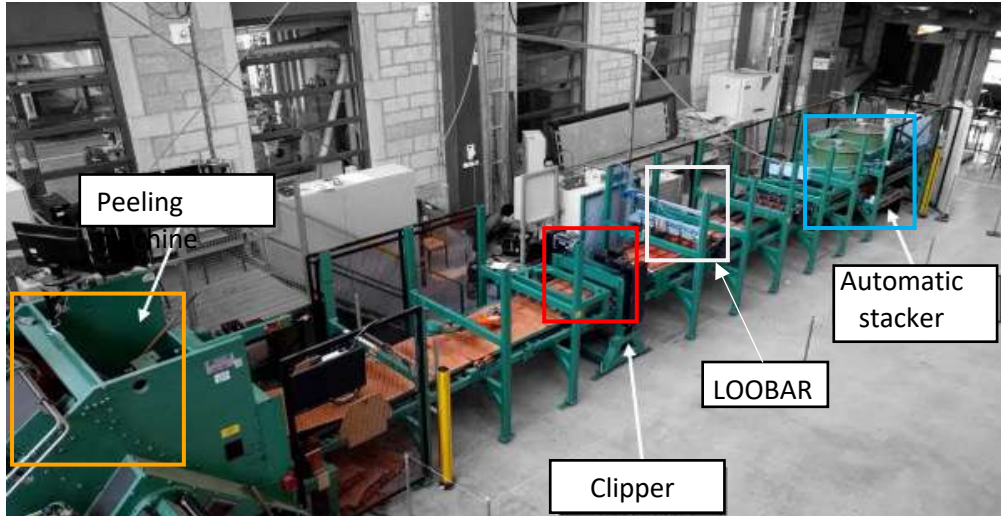

Industrial rotary peeling line

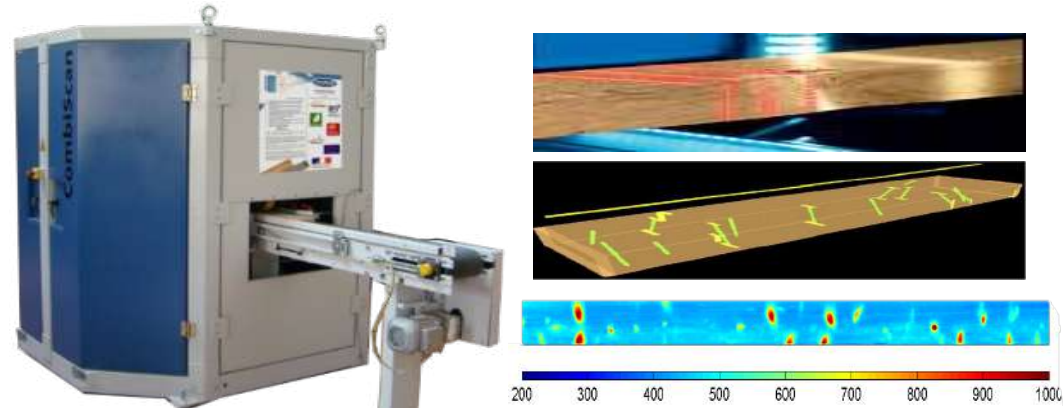

X-ray Scanner "COMBISCAN" (Post-mortem measurement of local densities)



Universal Testing Machine "ZWICK" (compression, tensile and pressure tests)

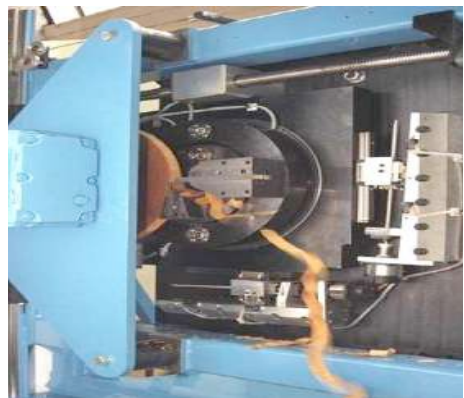

Instrumented micro-peeling

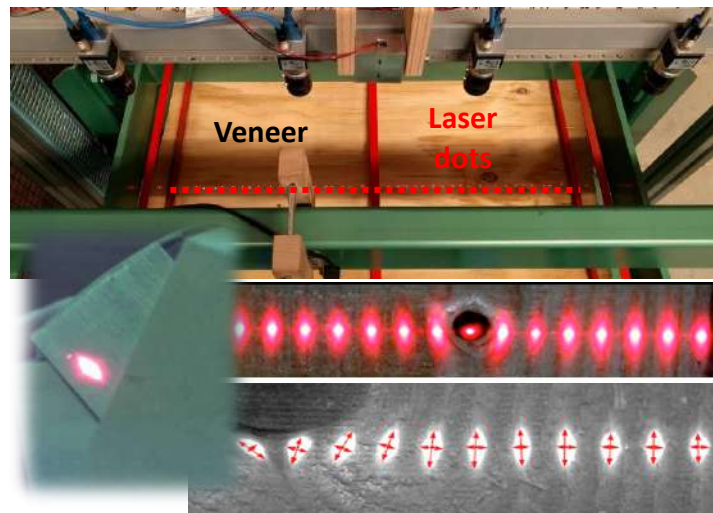

Laser scanner "LOOBAR" (In-Situ measurement of local fiber orientation)

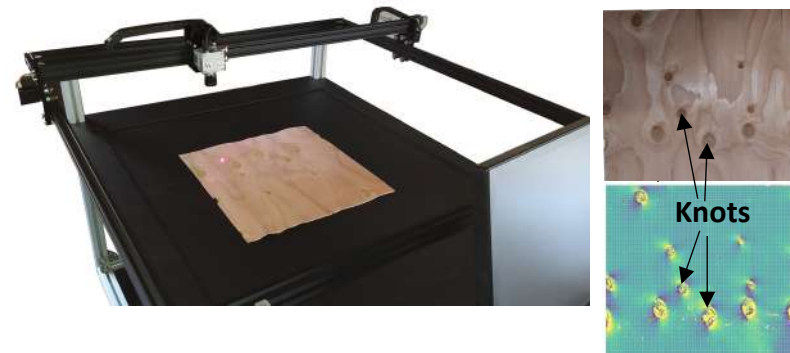

Laser scanner "JORUK" (Post-mortem measurement of local fiber orientation)

## WMM RESEARCH DOMAINS

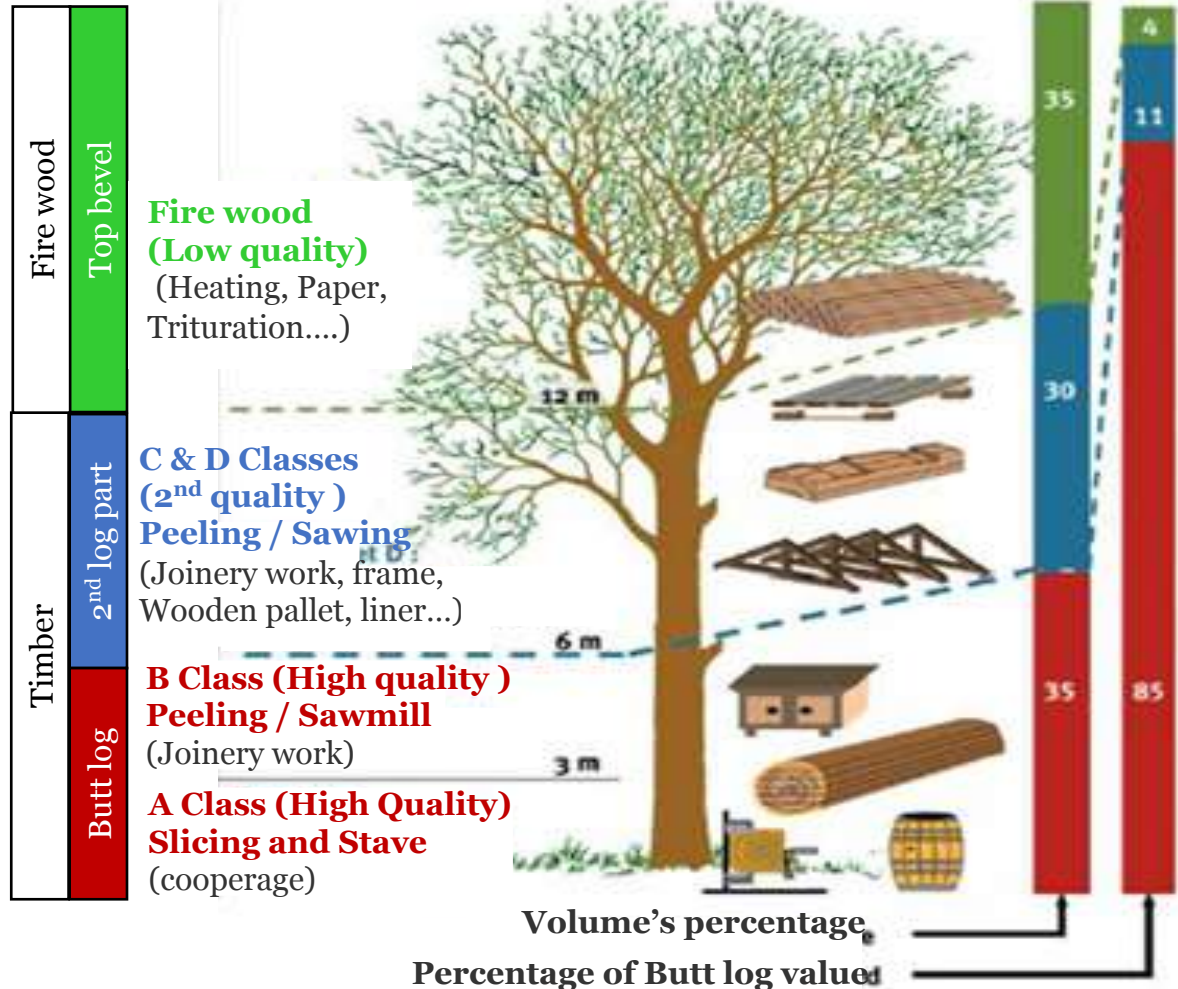

- Integration of local hardwood (oak, beech, poplar...) and softwood (Douglas fir, Spruce,...) species in industrial applications
- Efficient use of fast-growing trees

### 1<sup>st</sup> axis: Pre-machining

- Silvicultural / Forestry stations
- Wood species and heterogeneity
- Hygrothermal wood preparation

### 2<sup>nd</sup> axis: Machining processes

- Wood Peeling
- Wood Sawing

### 3<sup>rd</sup> axis: Post-machining

- Elaboration and characterization of engineered wood products

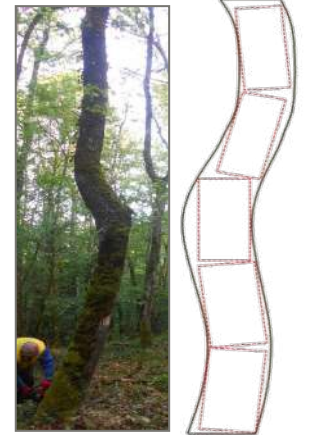

## CSC – PHD TOPIC: FINITE ELEMENT ANALYSIS FOR OPTIMUM PEELING CONDITIONS AND HIGHER VENEER QUALITY

Steaming



Stacking



Peeling



Drying



Clipping



Gluing



VENEER QUALITY



Wood peeling



## CSC – PhD TOPIC: FINITE ELEMENT ANALYSIS FOR OPTIMUM PEELING CONDITIONS AND HIGHER VENEER QUALITY

### 1. Multi-scale approach: Numerical analysis

#### Step 1

- ✓ Heterogeneous material
- ✓ No pressure bar

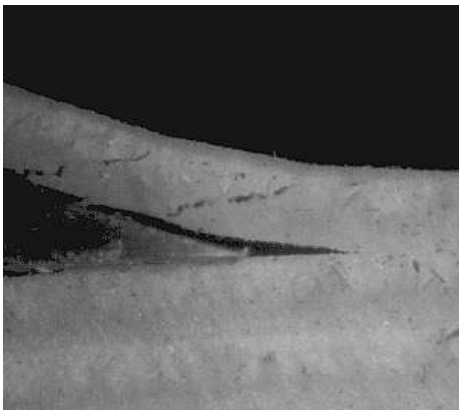
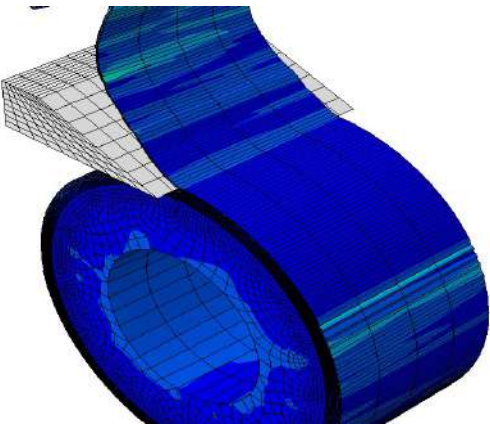

#### Step 2

- ✓ Material heterogeneity
- ✓ Consideration of annual rings
- ✓ Cutting along / against annual ring

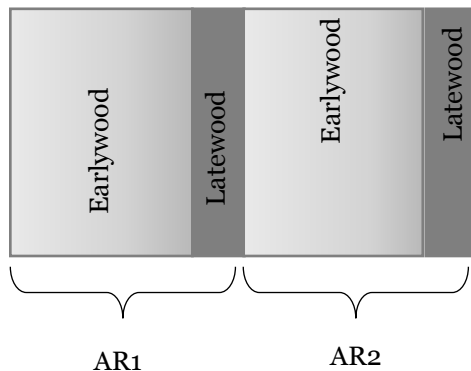
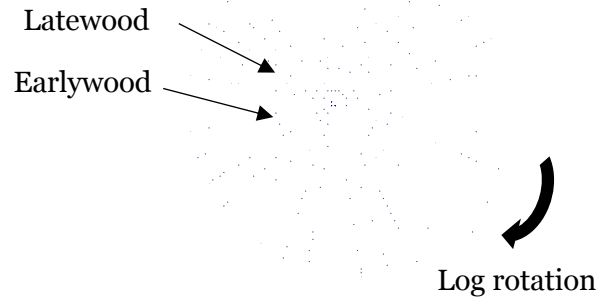

#### Step 3

- ✓ Knots and pressure bar effects

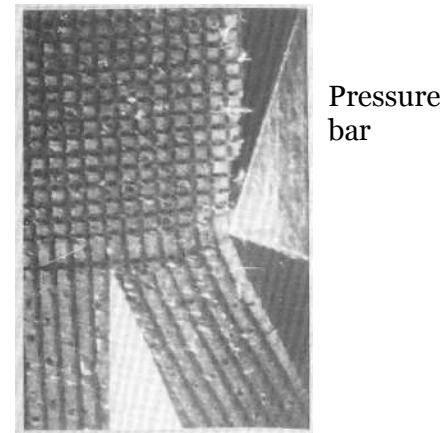
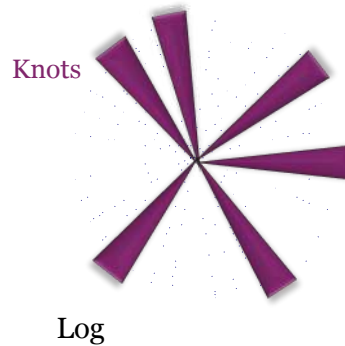

Accurate prediction of real wood behavior during the peeling process

Controlled lathe checks phenomenon

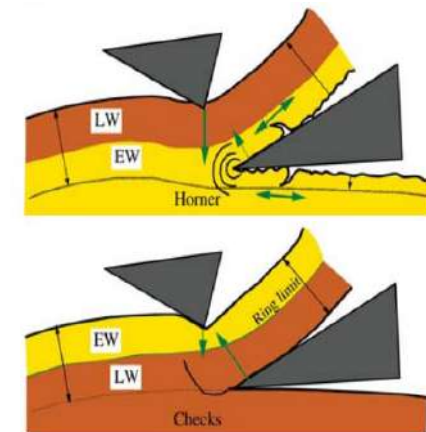



## CSC – PHD TOPIC: FINITE ELEMENT ANALYSIS FOR OPTIMUM PEELING CONDITIONS AND HIGHER VENEER QUALITY

### 2. Experimental validation

#### Vibro-acoustic Analysis

- ✓ Cutting forces
- ✓ Vibrations
- ✓ Sounds

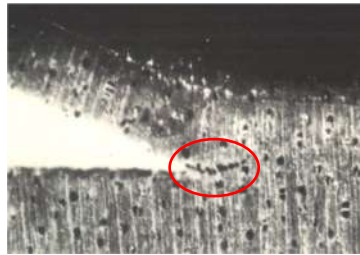

Lathe check initiation

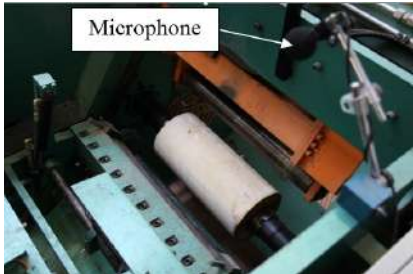
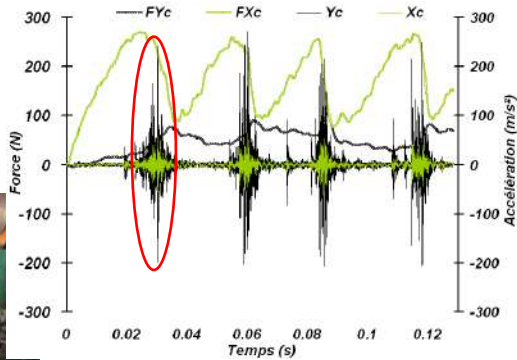

Microphone



Accelerometers

#### Thermo-mechanical Analysis



- Measurement of:
- ✓ Forces applied to the knife and the pressure bar
  - ✓ Log temperature
  - ✓ Knife angle variation

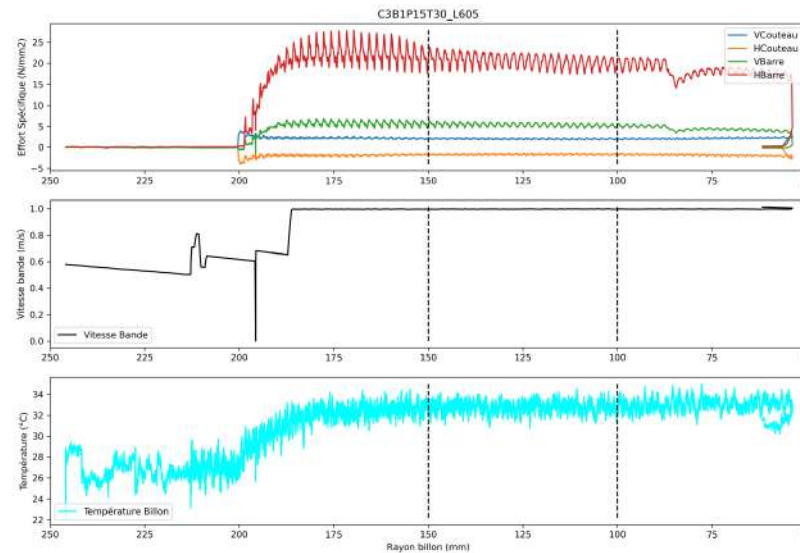

#### Analysis of veneer properties

- ✓ Veneer thickness
- ✓ Surface roughness

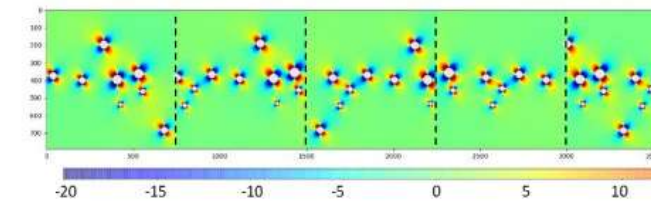
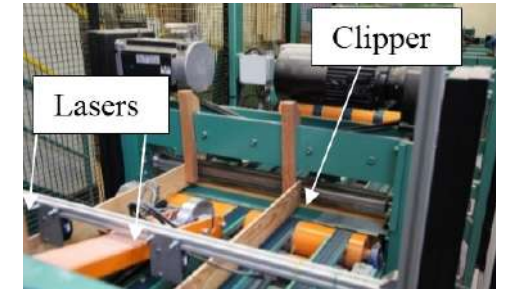

# ParisTech

#Connect

#Innovate

#Share

[www.paristech.fr](http://www.paristech.fr)





MSMP/ ARTS ET MÉTIERS  
MECHANICS, SURFACES AND MATERIALS PROCESSING

DIRECTOR: MOHAMED EL MANSORI



Research domains: Future manufacturing processes, material science, mechanics

**Multiphysical and multiscale  
approach to manufacturing  
processes - I2MP**

Team leader



Prof. Mohamed El  
Mansori  
*h*-index : 37

**Mechanics, Materials and Surfaces -  
MMS**

Team leader



Prof. Laurent  
Barrallier  
*h*-index : 18

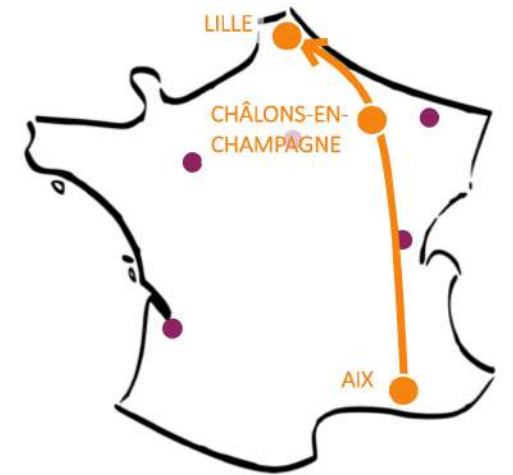

## KEY FACTS / FIGURES



Number of teacher-researchers : 33 (20% international)  
Number of PhD candidates : 11 including 25 % of international PhD candidates  
Number of engineers & administratives : 10  
Number of post-docs: 2



Prestigious partnerships with academic laboratories, companies:



Number of publications > 200



Number of filed patents > 5



RENAULT



SEEING THE WORLD BETTER



thyssenkrupp



Ingenuity for life



Research domains I2MP : Multiphysical and multiscale approach to manufacturing processes  
**Functional qualification of industrial surfaces by metrology, advanced modelling, and intelligent sensing**

### Full scale manufacturing platforms:

- Foundry and Die-casting
- Additive Manufacturing 3D Printing
- Machining Process
- Assembly and Forming
- ...



Foundry/3D printer



Sand Casting Foundry



Wire Arc Additive Manufacturing



Machining Process

### Surface characterization

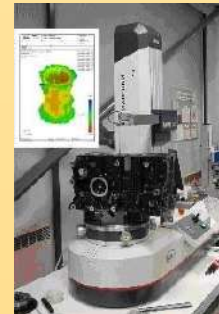

- Atomic force microscopy
- Interferometer
- SEM
- Nanoindenter
- ...

### Advanced multiscale modelling

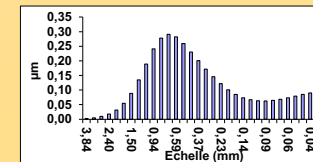
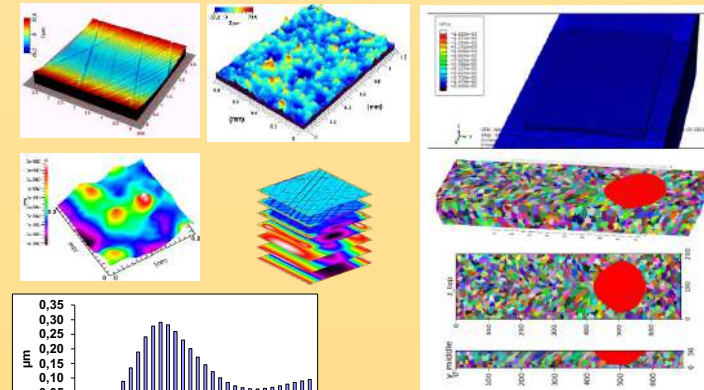

- Multi-scale surface analysis
- Advanced simulation techniques
- Artificial Intelligence
- ...

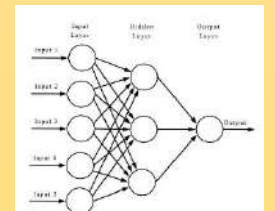

I2MP PhD  
projects:



**Prof. Mohamed El Mansori**  
<https://www.researchgate.net/profile/Mohamed-El-Mansori>  
*h-index : 37*



**Nan Kang – Associate Professor**  
<https://www.researchgate.net/profile/Nan-Kang-7>  
*h-index : 24*

## Subject 27

Mechanical and functional fatigue behaviour of laser powder bed fusion processed Ni-Ti shape memory alloy



SMA tire (NASA)

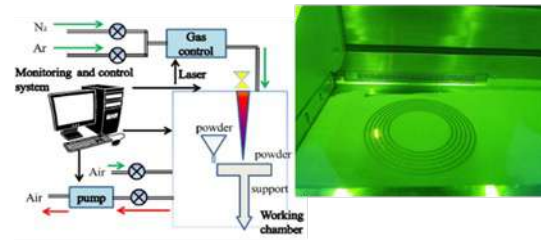

## Subject 28

Investigation on microstructure and strengthen mechanism of laser powder bed fusion high temperature multi-reinforced Al matrix composite

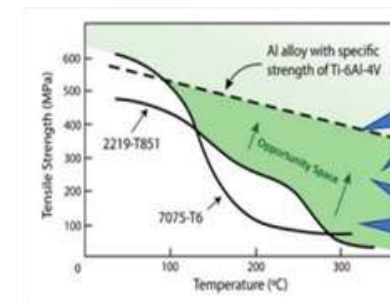

Research domains MMS : Optimization of the microstructure to improve the performance of mechanical parts

## From the microstructure to the mechanical properties of materials

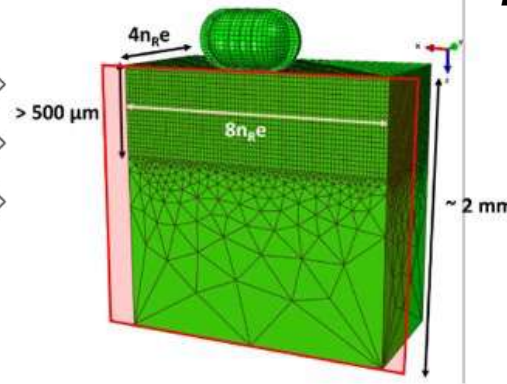
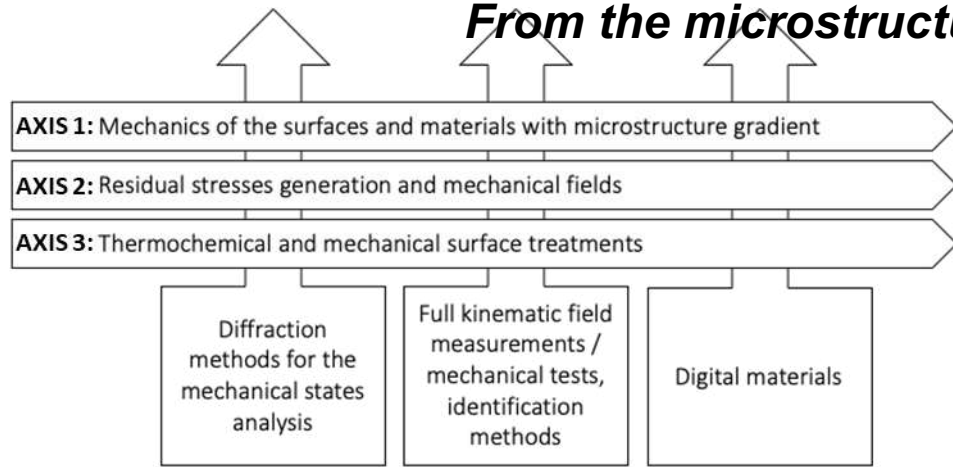

Some application fields:

- **Nuclear Energy** (UO<sub>2</sub>), mechanical behavior, irradiation effect [\\ CEA](#)
- **Shot peening** (15 PhD thesis): from the mechanical surface treatment to the fatigue life [\\ PSA, Safran, AREVA, EDF, INSA, UTT, Onera](#)
- **Nitriding** (11 PhD thesis): from the process parameters to the use [\\ Airbus, Safran, Aubert & Duval, Bodycote, Transvalor, DTU](#)
- **Diffraction method** for mechanical states analysis (X-ray, neutron, synchrotron, electron)
- ...

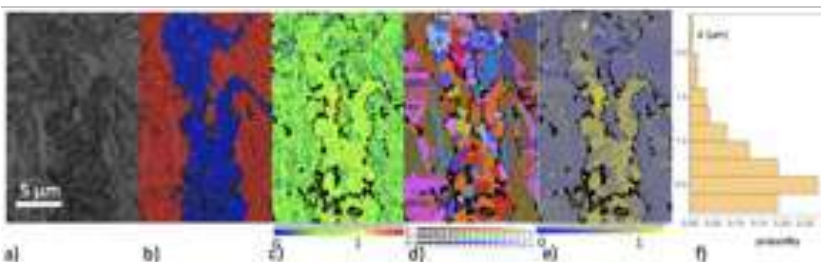
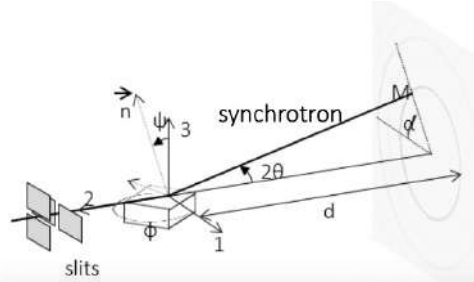
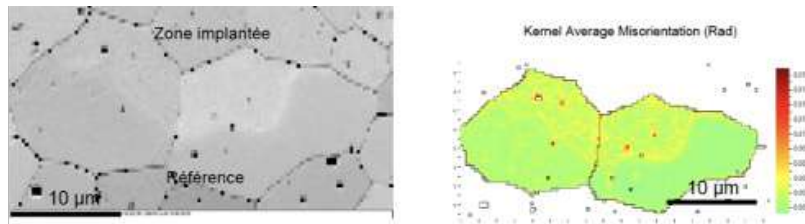

Gases reactive facilities

SEM

Mono impact

X-ray diffractometer

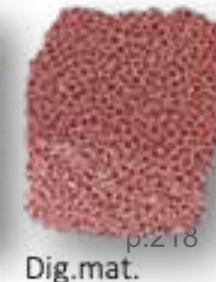

Dig.mat.



MMS PhD projects:



Prof. Laurent Barrallier

<https://www.researchgate.net/profile/Laurent-Barrallier>

## Subject 7

Multiscale stress/strain analysis of polycrystalline silicon for photovoltaic applications

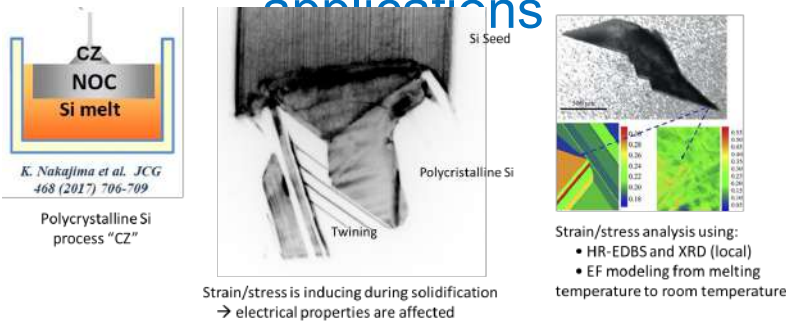

Dr. Mohamed Fares Slim

<https://www.researchgate.net/profile/Mohamed-Fares-Slim>

## Subject 17

Study of the microstructure, mechanical and fatigue properties of Ti-6Al-4V and AL-Co-Cr-Fe-Ni high entropy alloys components fabricated by wire-arc additive manufacturing

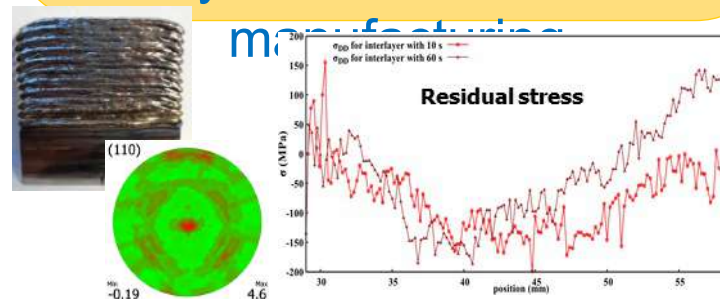

Dr. Dorian Depriester

<https://www.researchgate.net/profile/Dorian-Depriester>

## Subject 20

Multiscale simulation of plastic strain localization in high entropy alloys

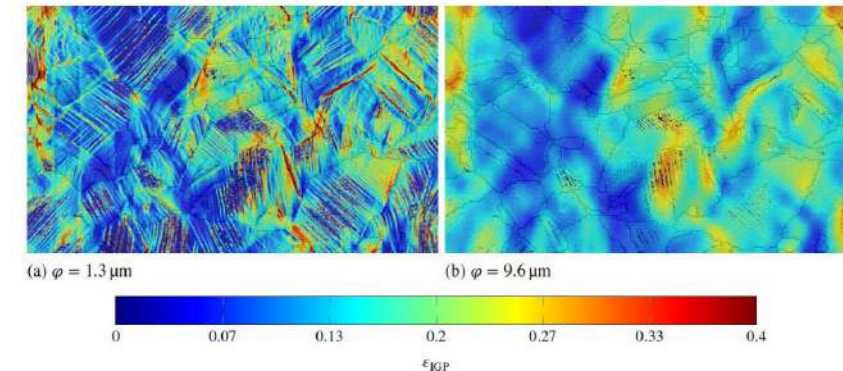

MMS PhD projects:



Prof. Laurent Barrallier

<https://www.researchgate.net/profile/Laurent-Barrallier>



Dr. Jean-Patrick Goulmy

<https://www.researchgate.net/profile/Jean-Patrick-Goulmy>

**Subject 22**  
Optimized set-up to characterize the contact fatigue damage of material with gradient properties

**Subject 23**  
A smart manufacturing project: Digital Image Correlation characterization of residual stresses induced during the shot peening process

**Subject 24**  
Characterization of the evolution of mechanical properties of materials during in-situ SEM tests in temperature: implementation of the HRDIC technique

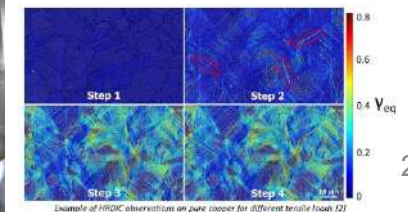
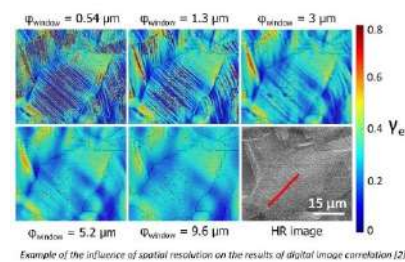
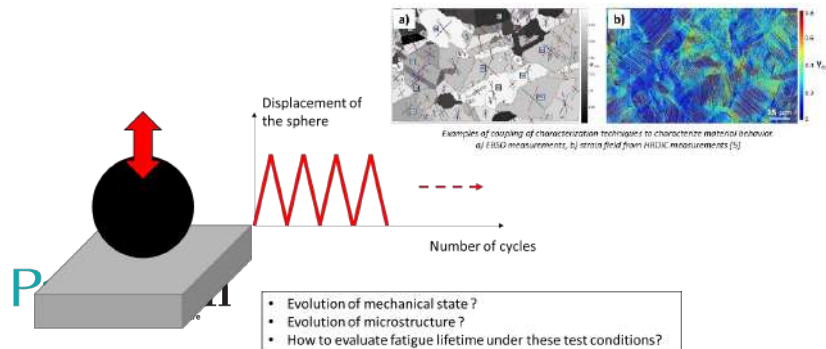

# ParisTech

#Connect

#Innovate

#Share

[www.paristech.fr](http://www.paristech.fr)



in



f

# ENSAM LAB: DYNFLUID - DYNAMIQUE DES FLUIDES



Lab Director :

Jean-Christophe ROBINET  
Jean-christophe.ROBINET@ensam.eu

Pictures / Logos

RESEARCH TOPICS: at DynFluid, research is organized into 4 themes:

Topic 1: Multi-Species and Complex Thermodynamics

Topic 2: Compressible, Turbulence and Acoustics

Topic 3: Machine Learning and Uncertainty Quantification

Topic 4: Transition, Instability, Transition and Control

[Website](#)

le cnam

Arts Institute of  
Technology  
et Métiers

# ENSAM LAB: DYNFLUID - DYNAMIQUE DES FLUIDES



Lab Director :

Jean-Christophe ROBINET  
Jean-christophe.ROBINET@ensam.eu

## Main Project :

ANR- REGAL/ORC (REal-GAs effects on loss mechanisms of ORC turbine flows)

## Partner:

- TUI Technische Universität Ilmenau
- ENSAM -- DynFluid
- FH MS Muenster University of Applied Sciences
- IJLRDA Institut Jean Le Rond D'Alembert

Grants: 200k€

## Objectives :

- Understand and predict the dynamics of dense gas flows
- Describe transition mechanisms
- The physical properties of turbulence

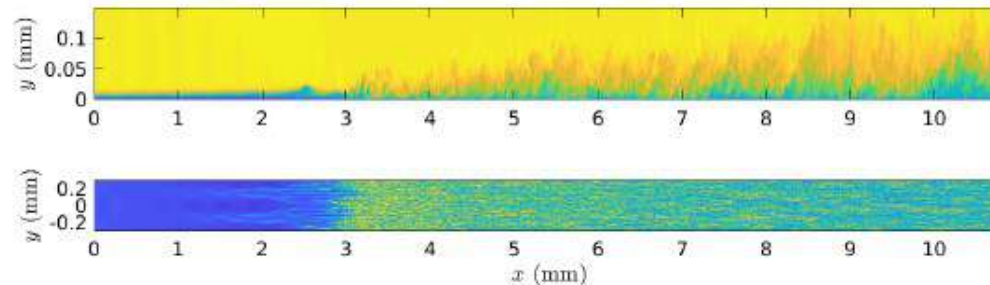

## Methods :

- High order numerical simulations,
- Synthetic turbulence generation
- Advanced signal post-processing

# ENSAM LAB: DYNFLUID - DYNAMIQUE DES FLUIDES



Lab Director :

Jean-Christophe ROBINET  
Jean-christophe.ROBINET@ensam.eu



## Main Project :

CleanSky (H2020) PERSEUS (Pulsed jet actuators for Separation control of turbulent flows)

## Partner:

- University of Orléans (Prisme Institute)
- INSA Toulouse (Clément Ader)
- Arts et Métiers Inst. of Tech. / DynFluid

Grants: 180k€

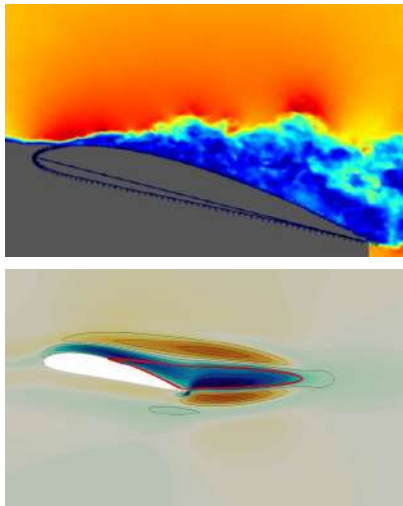

Internal & external high-fidelity simulations

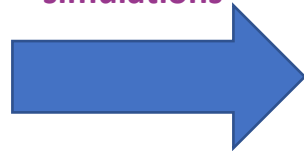

Sensitivity analysis

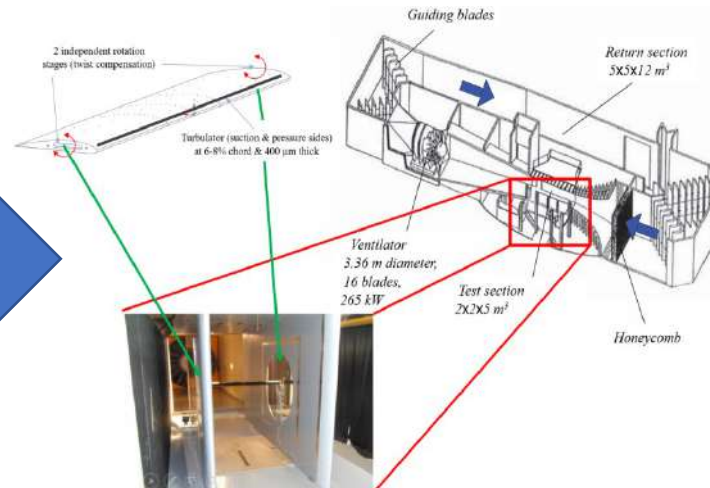

Well control experiments – high lift configurations

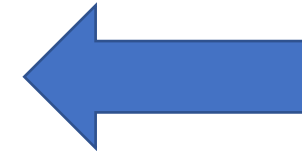

Innovative design of pulsed Jet actuators

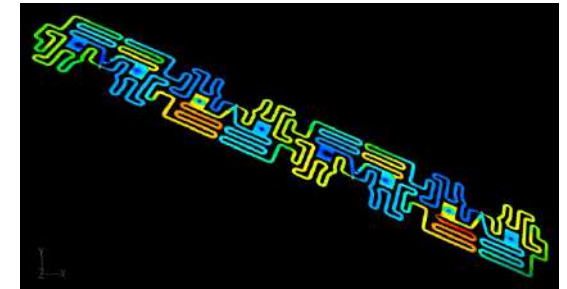

# ENSAM LAB: DYNFLUID - DYNAMIQUE DES FLUIDES



Lab Director :

Jean-Christophe ROBINET  
Jean-christophe.ROBINET@ensam.eu

## Main Project :

DGAC/Airbus MAMBO  
(Méthodes Avancées pour la Modélisation du Bruit  
moteur et aviOn)

## Partners:

- Airbus SAS, Airbus OP
- ArianeGroup
- ONERA / DAAA / DMPE
- ISAE-Supaéro / DAEP
- ISAE-ENSMA Poitiers / Institute Pprime
- Arts et Métiers Inst. of Tech. / DynFluid
- Sorbonne Univ. / IJLDA
- Ecole Centrale de Lyon / LMFA
- Safran Aircraft Engine

Grants: 200 k€

## Objectives :

Understand, predict and  
reduced the noise  
radiation of supersonic jet

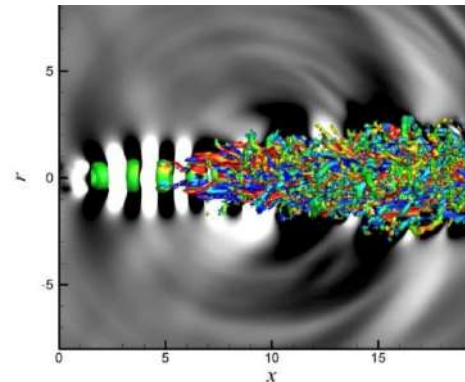

## Methods :

- High order numerical simulations,
- Automatic differentiation,
- Modal decompositions
- Optimal control by adjoint methods

PhD subject

# Study of the low frequency dynamics of compressible separations

**Ismail BEN HASSAN SAÏDI** (DynFluid, Arts et Métiers)

**Jean-Christophe ROBINET** (DynFluid, Arts et Métiers)

**Christian TENAUD** (EM2C, CentraleSupelec, CNRS)



# Study of the low frequency dynamics of compressible separations

## ► Industrial context: supersonic aerodynamics

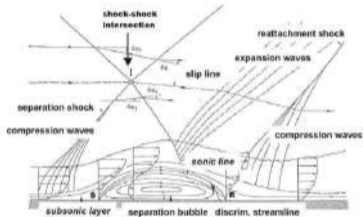

[Arnal and Delery, 1971]

## ► Physical issues:

- broadband dynamics  
 → low frequency oscillations of shock / recirculation bubble system
- what physical mechanism explains the low-frequency dynamics?

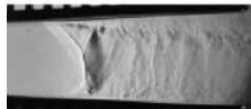
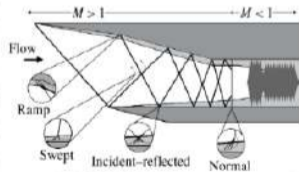
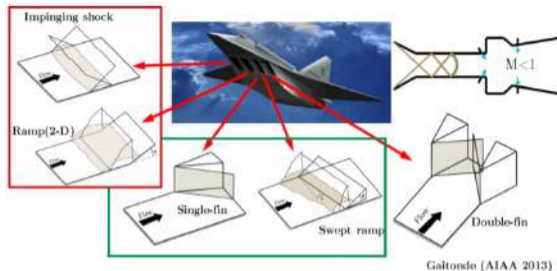

[Grossman and Bruce, 2018]

# Study of the low frequency dynamics of compressible separations

- ▶ **Goal of the PhD:** Physical analysis → describe the physical mechanism at play for low frequency dynamics
- ▶ **Outline:** Focus on **laminar and transitional SWBLIs**
  - High-fidelity **numerical simulation** of SWBLIs (LES)
    - In-house code, parallel computing (**HPC**), statistical convergence, shock-capturing procedures, etc.
  - Physical analysis:
    - Modal decompositions: SPOD, DMD, BSMD
    - Stability analysis
  - Comparison with turbulent SWBLIs

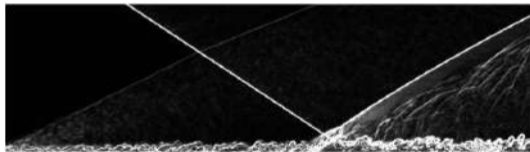

*[Ben Hassan Saïdi, PhD Thesis, 2019]*

- ▶ **Candidate profile:**
  - Specialized in fluid mechanics or applied mathematics
  - Interested in: supersonic aerodynamics, physical analysis, dynamical systems
  - Skill in programming (Fortran, python ...), experience in HPC appreciated.
- ▶ **PhD location:** at DynFluid, Arts et Métiers institute of Technology. National and international collaborations

# ParisTech

#Connect

#Innovate

#Share

[www.paristech.fr](http://www.paristech.fr)





# Acoustic lubrication of dense non-Brownian suspensions

X. JIA, A. TOURIN, A. COLIN

# Background: non-Brownian suspensions

- Made of hard particles + Newtonian fluid
- Display a wide variety of behaviors:



# Carbon black suspensions

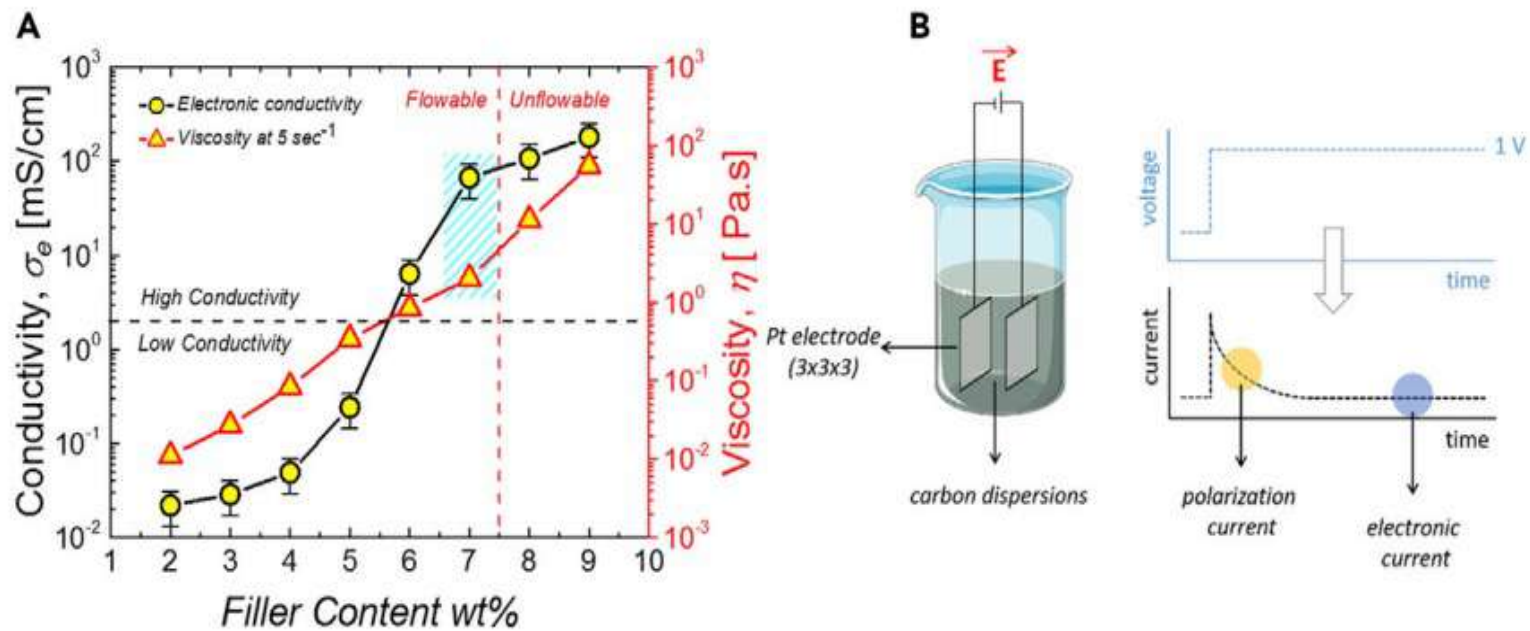

# Potential applications

Ex: 3D printing of composite materials

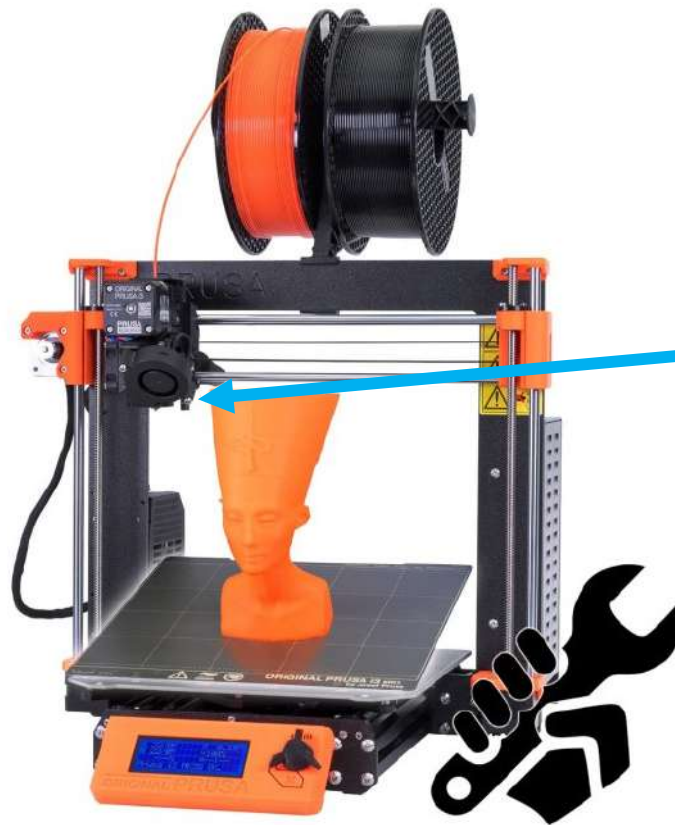

Printing fuse:

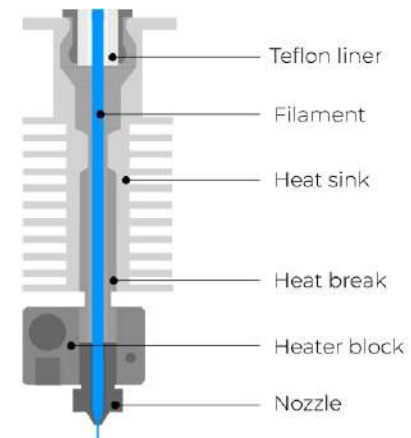

Or fluidize any suspension flow in microfluidics...

# Acoustic lubrication

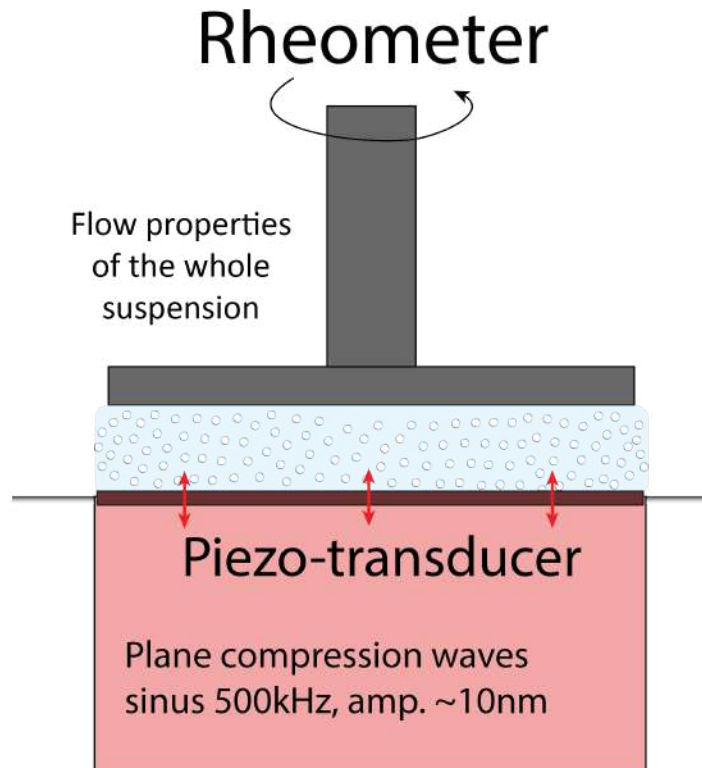

Top view

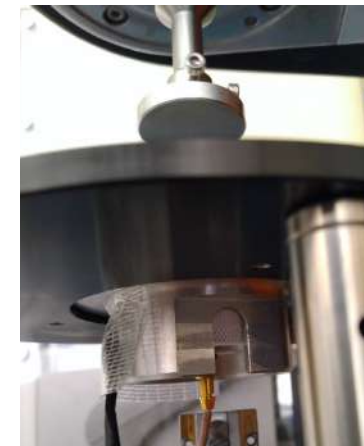
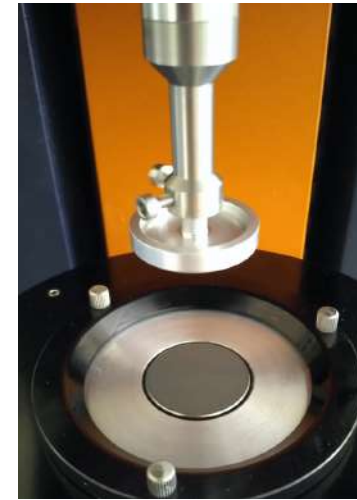

Bottom view



# Effect of ultrasounds on dilute model suspensions

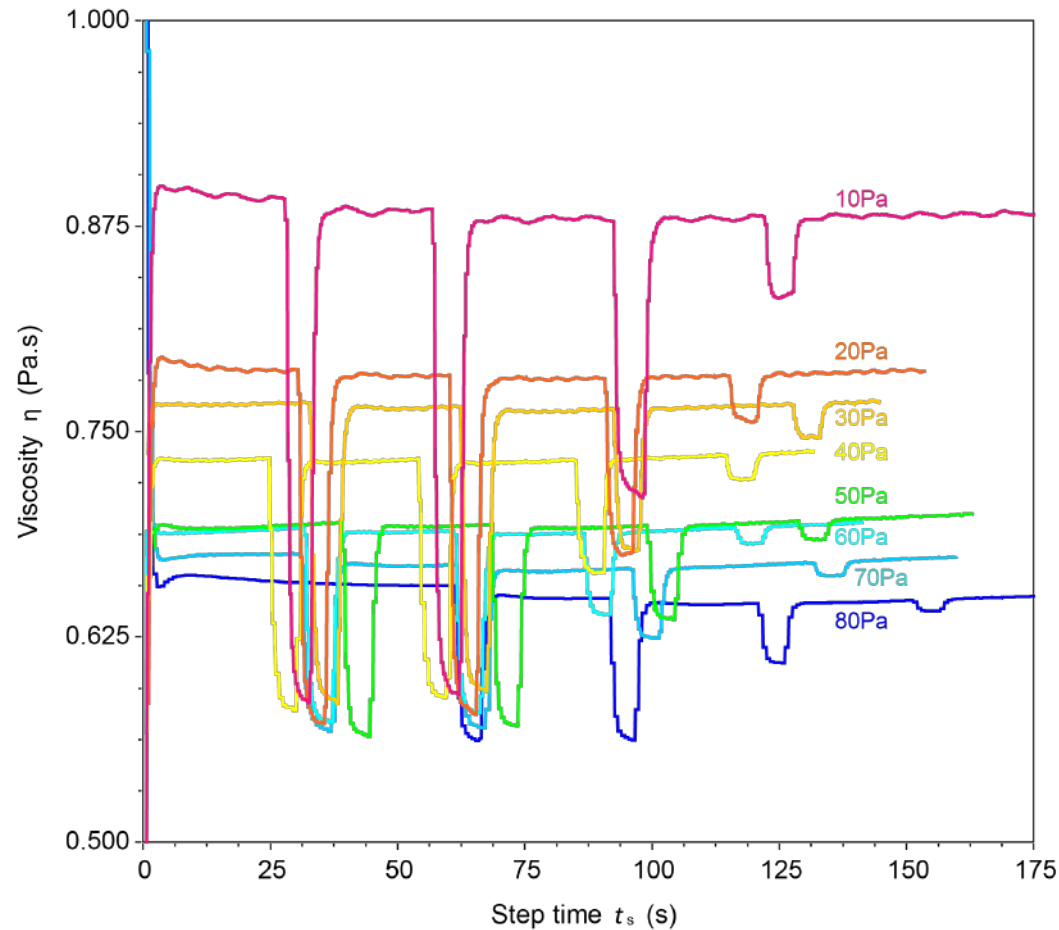

# Acknowledgments

The whole MIE team at ESPCI:

**Annie Colin**

 @adrienizzet

Arnaud Tourin



Xiaoping Jia

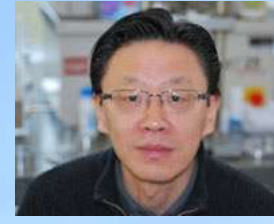

Guillaume Ovarlez



# ParisTech

#Connect

#Innovate

#Share

[www.paristech.fr](http://www.paristech.fr)



in



f



ParisTech



## **6. LABS AND PHD**

### **PROPOSALS**

ROOM 4 /PHYSICS, OPTICS

# ROOM4 - Physics, Optics PROPOSALS/LABS

File Number	School	Title	Advisors	Lab
2022_043	ESPCI Paris - PSL	High temperature superconductors for single photon detection	Cheryl FEUILLET-PALMA	LPEM - Laboratoire Physique et d'études des matériaux
2022_051	ESPCI Paris - PSL	Electronic structure of the intercalated graphene-Ge interfaces	Dimitri Roditchev, Yuriy Dedkov, Sergio Vlaic	LPEM - Laboratoire Physique et d'études des matériaux
2022_081	ESPCI Paris - PSL	VO <sub>2</sub> -based Plasmonic Hybrid Nanostructures for Tunable Optical Sensors	Lionel Aigouy, Alexandre Zimmers, Zhuoying Chen	LPEM - Laboratoire Physique et d'études des matériaux
2022_077	Institut d'Optique Graduate School	Coherent manipulation of entangled emitters	Brahim LOUNIS, Jean-Baptiste TREBBIA	LP2N - Laboratoire Photonique, numérique et nanosciences
2022_078	Institut d'Optique Graduate School	Quantum optics with perovskite single nanocrystals and superlattices	Brahim LOUNIS, Philippe TAMARAT	LP2N - Laboratoire Photonique, numérique et nanosciences
2022_080	Institut d'Optique Graduate School	Fast Josephson-junction control by optical manipulation of a flux quantum	Brahim LOUNIS, Philippe TAMARAT	LP2N - Laboratoire Photonique, numérique et nanosciences
2022_061	Institut d'Optique Graduate School	High sensitivity Atom Interferometry using multi-photon interrogation in an optical cavity	Benjamin Canuel	LP2N - Laboratoire Photonique, numérique et nanosciences
2022_003	ESPCI Paris - PSL	Active Solids	Olivier Dauchot	GULLIVER - Voyages expérimentaux et théoriques en matière molle
2022_004	ESPCI Paris - PSL	Morpho-Functional Swarm Robotics	Olivier Dauchot	GULLIVER - Voyages expérimentaux et théoriques en matière molle
2022_100	Institut d'Optique Graduate School	Production of striking visual appearance with disordered metasurfaces	philippe Lalanne	LP2N - Laboratoire Photonique, numérique et nanosciences

COLLABORATION:

OPTICAL CONDUCTIVITY AND QDEV GROUPS

HIGH TEMPERATURE SUPERCONDUCTORS FOR SINGLE PHOTON DETECTOR

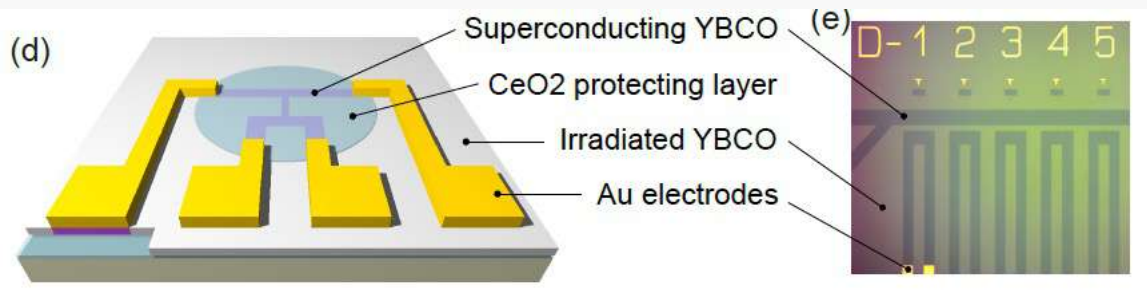

KEY RESEARCHERS  
OPTICAL CONDUCTIVITY / QDEV  
GROUP



CHERYLL  
FEUILLET-PALMA



RICARDO  
LOBO

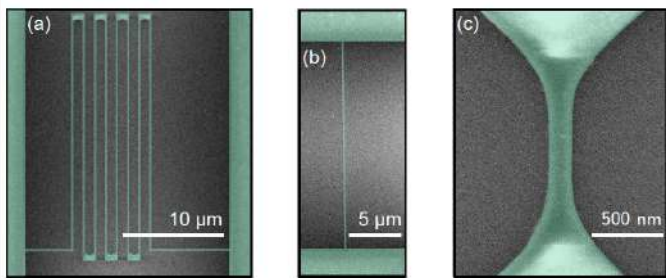

SEM images of several nanowire

Quantum Transport 4K :

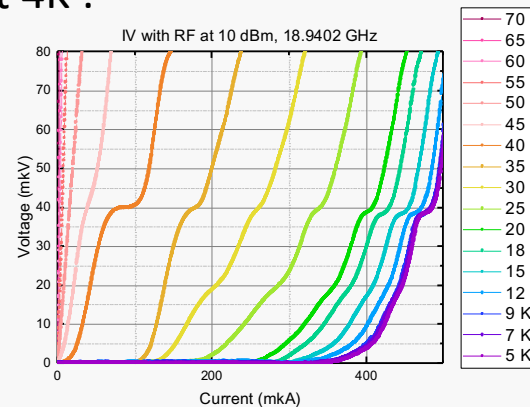
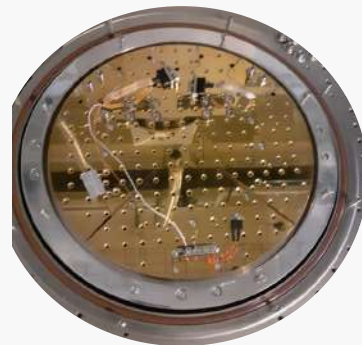

# ParisTech

#Connect

#Innovate

#Share

[www.paristech.fr](http://www.paristech.fr)



**CSC PhD proposal:  
High sensitivity Atom Interferometry using multi-  
photon interrogation in an optical cavity**

**Context and team presentation**

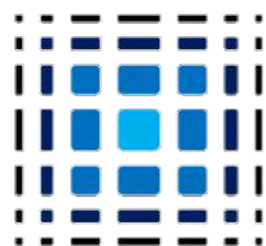

**LP2N**  
Laboratoire Photonique  
Numérique & Nanosciences

INSTITUT  
d'OPTIQUE  
GRADUATE SCHOOL  
ParisTech



université  
de BORDEAUX



# Team Large Scale Atom Interferometry to study gravity

Study atom gradiometry techniques for new class of research Infrastructures

- Fundamental physics (Relativity, Gravitational Waves, dark matter...)
- Geoscience (geology, seismology, hydrogeology...)

Activities:

- Leading the MIGA antenna
- Experimental developments at LP2N:
  - In cavity Atom Interferometry
  - 6 m gradiometer
- Noise Models, metrology and further developments: ELGAR

# The MIGA antenna

Build a new instrument combining matter-wave and laser interferometry

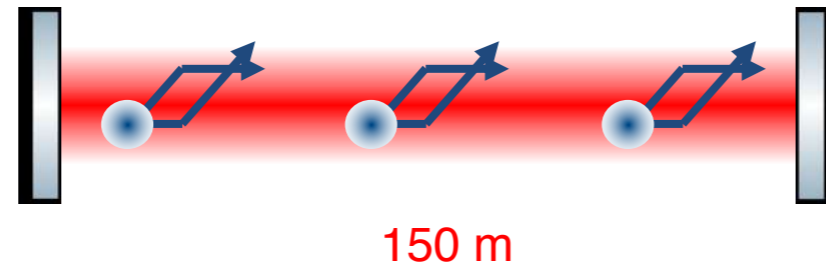

A Large research infrastructure hosted in a low noise laboratory

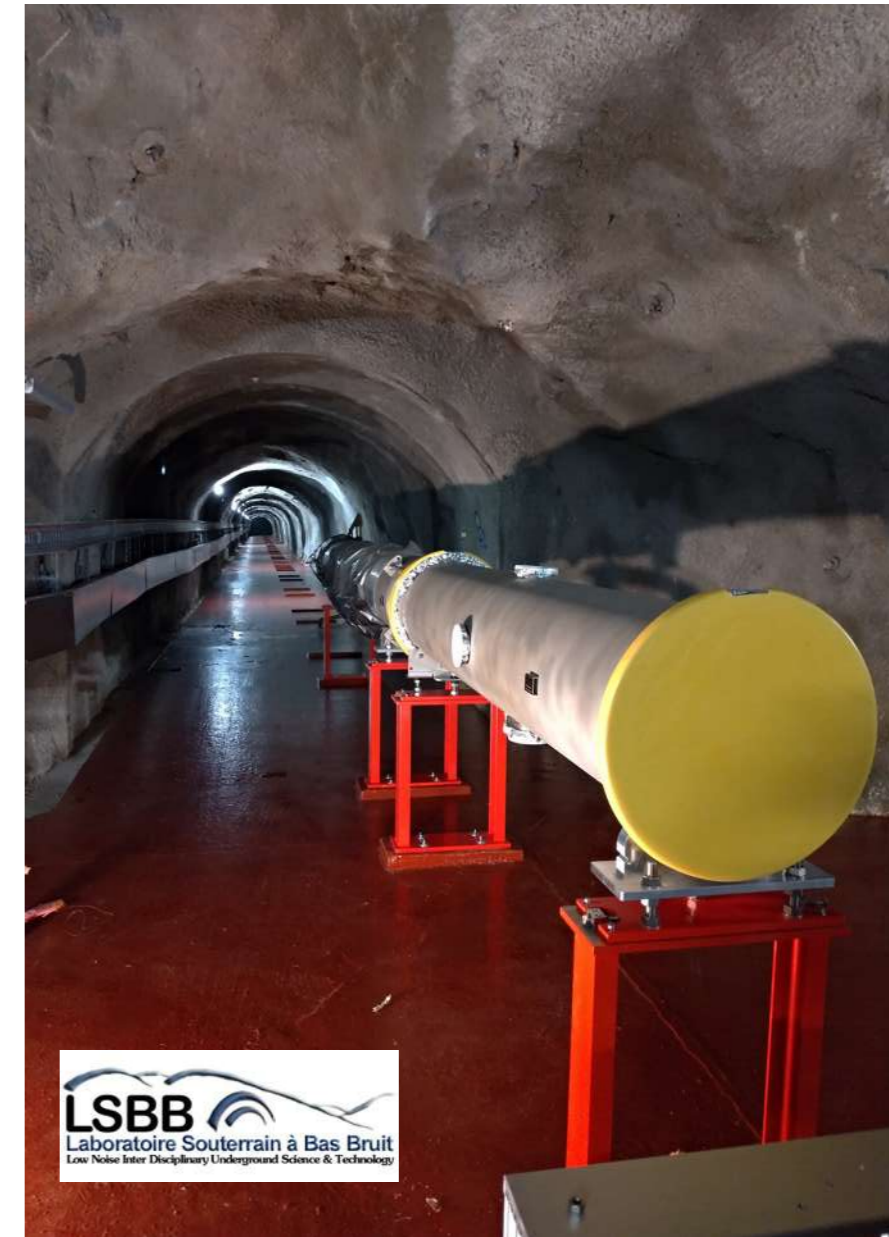
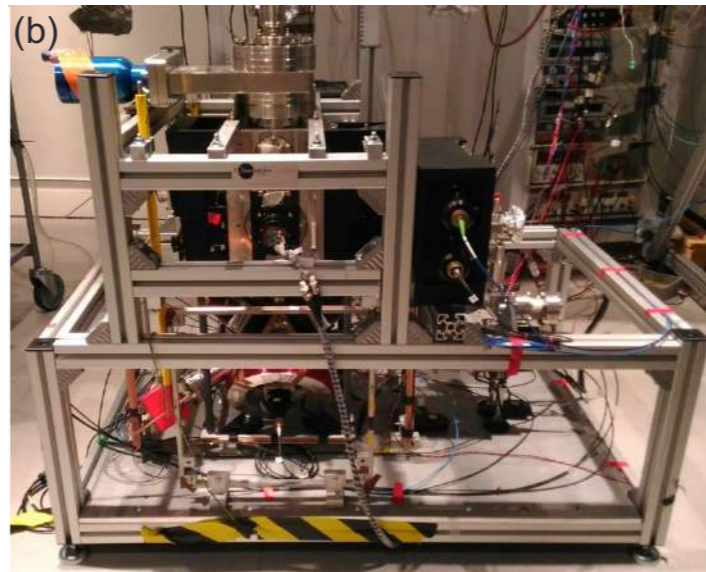
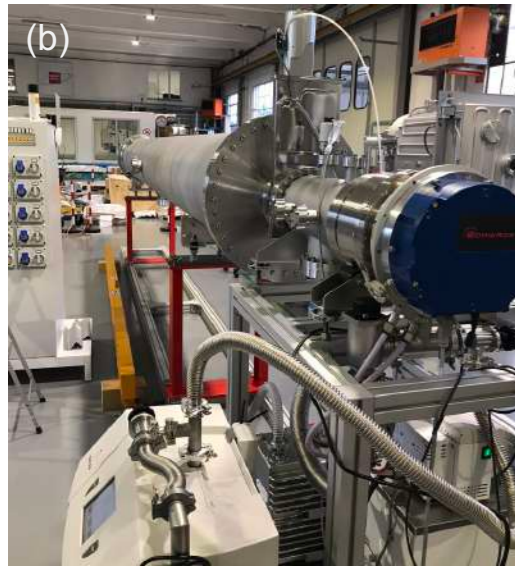

**LSBB**  
Laboratoire Souterrain à Bas Bruit  
Low Noise Interdisciplinary Underground Science & Technology

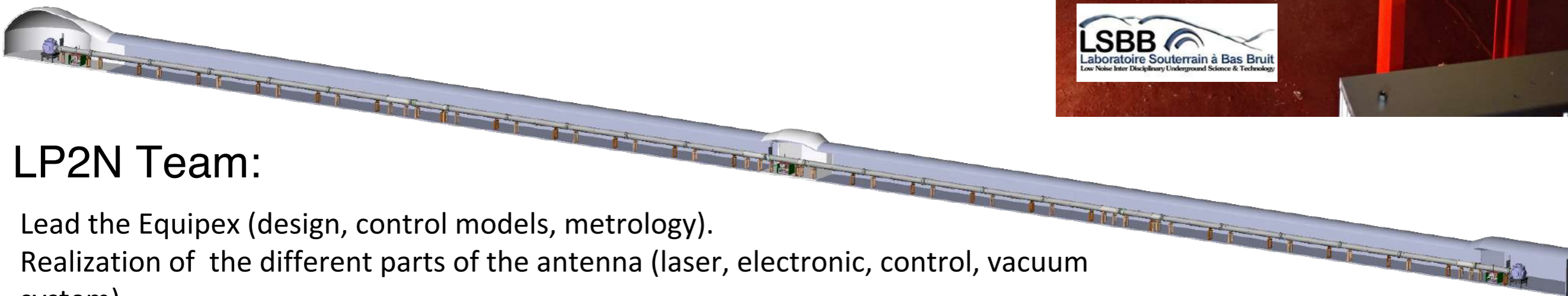

## LP2N Team:

- Lead the Equipex (design, control models, metrology).
- Realization of the different parts of the antenna (laser, electronic, control, vacuum system).
- Responsible for installing and commissioning.
- Prepare further developments: study advanced atom interferometry techniques

# Atom interferometry in cavity

- Test atom cavity interrogation on a reduced scale of 80 cm using a MIGA Rb source.
- Uses degenerate resonator geometry enabling a large resonating mode.

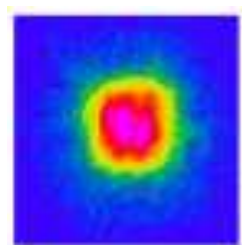
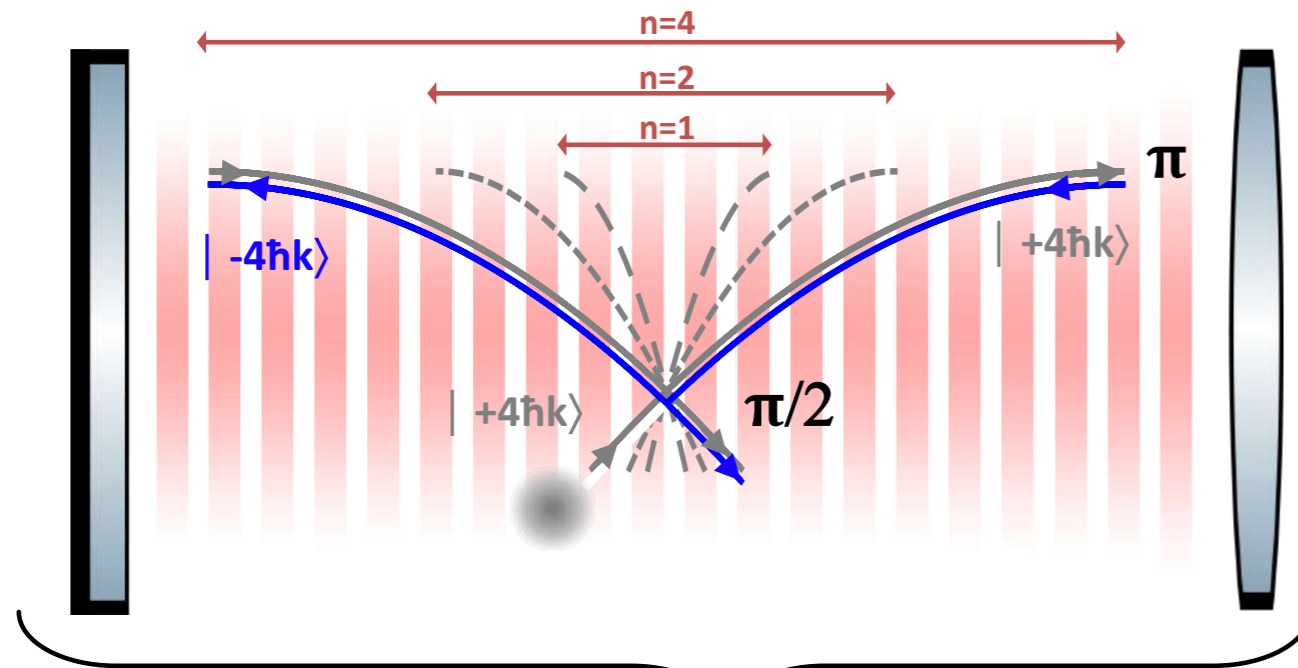
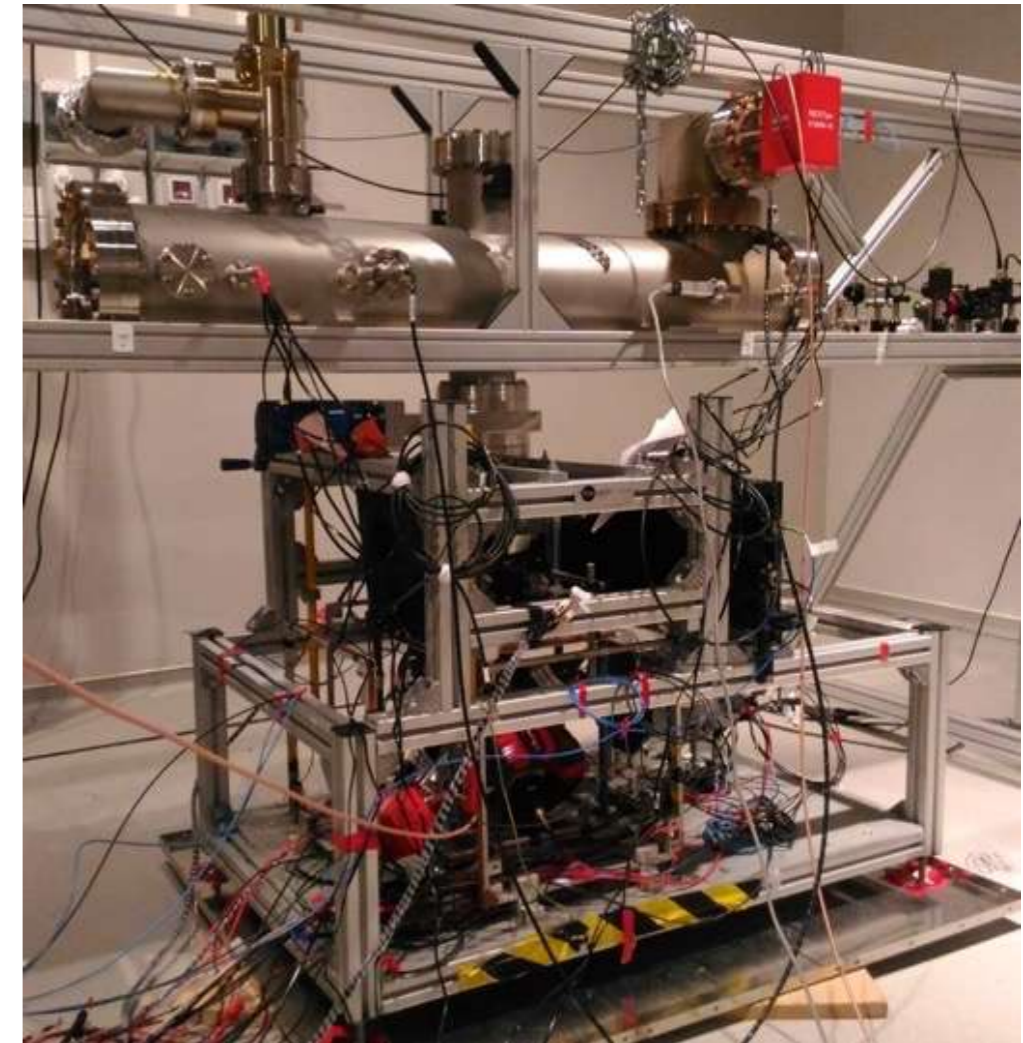

Resonant field diameter 4 mm

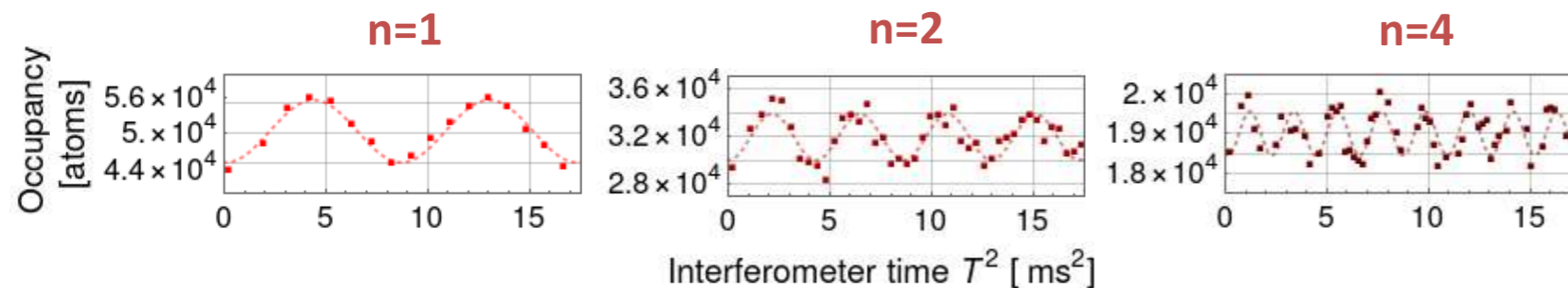
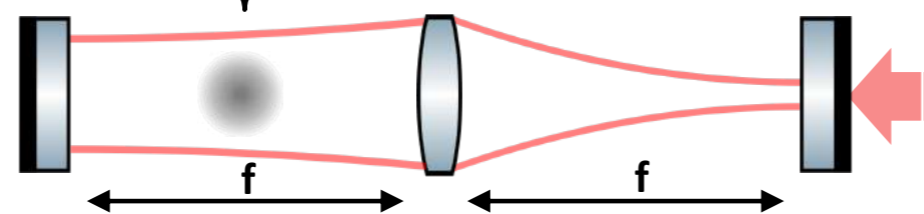

- Study of advanced atom manipulation techniques.
- Cavity build up help to reach high order Bragg diffraction: increase the separation of matter waves – ie sensitivity.

# 6 m gradiometer

A short-sized version of MIGA to study advanced atom interferometry techniques.

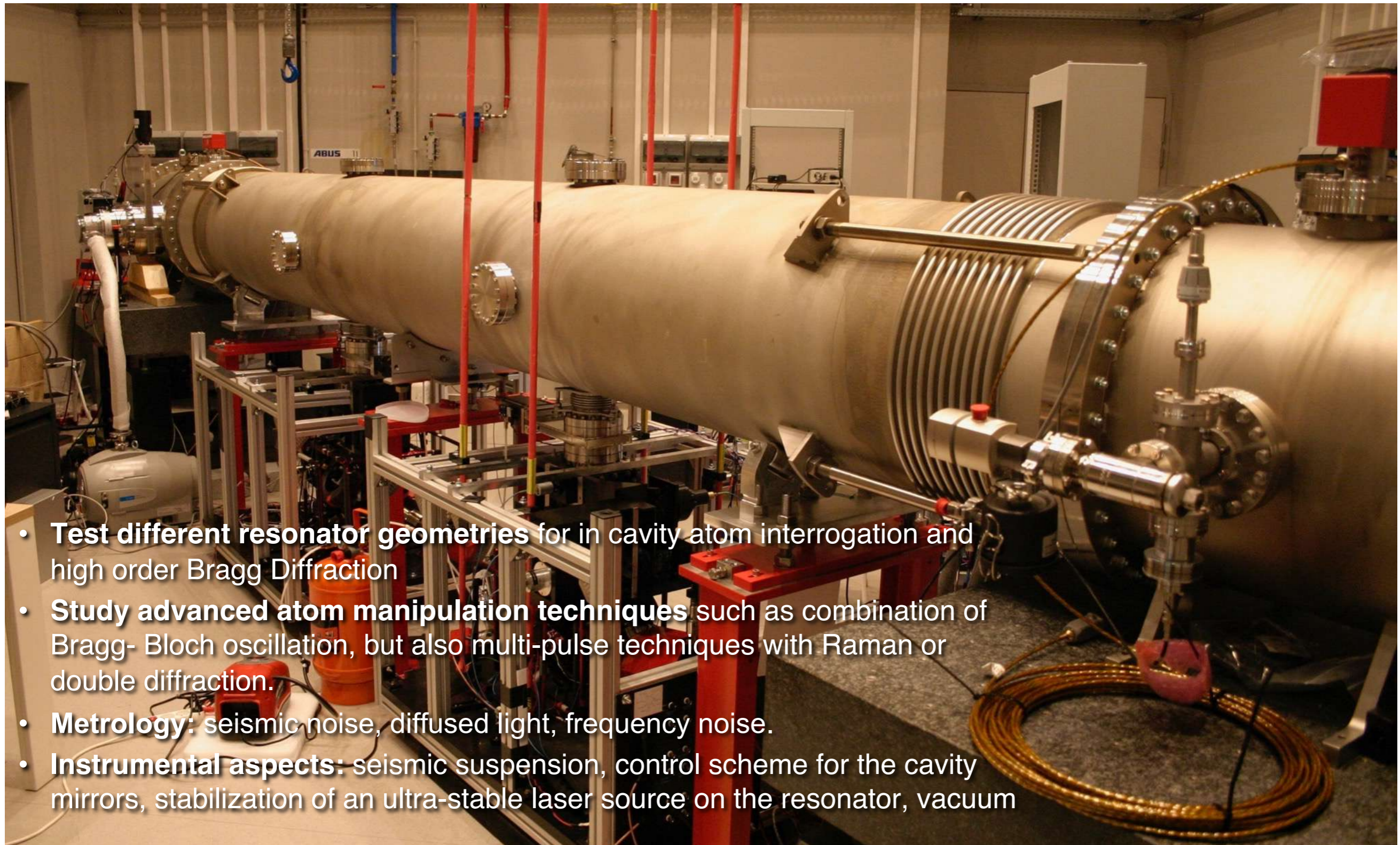

- **Test different resonator geometries** for in cavity atom interrogation and high order Bragg Diffraction
- **Study advanced atom manipulation techniques** such as combination of Bragg- Bloch oscillation, but also multi-pulse techniques with Raman or double diffraction.
- **Metrology:** seismic noise, diffused light, frequency noise.
- **Instrumental aspects:** seismic suspension, control scheme for the cavity mirrors, stabilization of an ultra-stable laser source on the resonator, vacuum

## PhD proposal

### High sensitivity Atom Interferometry using multi-photon interrogation in an optical cavity

Advisor: Canuel Benjamin, [benjamin.canuel@institutoptique.fr](mailto:benjamin.canuel@institutoptique.fr)

This PhD project seeks to exploit the promising potential of large momentum transferring beam splitters to boost the sensitivity of atom interferometer based experiments and heralds a new class of applications in fundamental physics such as studies of Dark Matter or Gravitational Waves. This project relies on the potential of optical resonators as a key technique for sensitivity improvement. Developments achieved by a few groups worldwide have recently led to multiple breakthroughs brought about by bespoke resonators designed for atom interferometry.

After pioneering results, obtained in the frame of "MIGA" project [1], with the demonstration of a matter wave interferometer in a 1 m marginally stable resonator [2] (see Fig. 1) this PhD project will focus the development of such a baseline of a few meters. As separated atom interferometers in an important immunity to common brics to build future high sensitivi

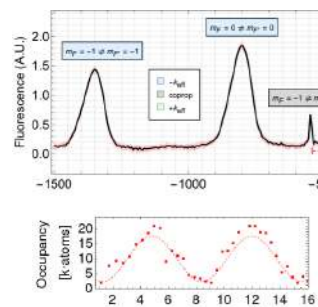

Figure 1: Atomic data. Top: Quali ballistic flight toward the interc from left to right, interference p:

The PhD project will benefit from the "MIGA project" at the LP2N lab of  $^{87}\text{Rb}$  launched on a vertical tra mode of horizontal cavities are us geometry.



Figure 2: Atom gradiometer experiment at LP2N laboratory.

While cavities are now considered as disruptive tools to improve atom interferometer sensitivity, the efficiency of this method scales with resonator finesse, for both scale factor improvement and future implementation of sub shot-noise measurement schemes. This PhD will therefore focus on the study of different atom interferometry geometries using high-finesse resonators with the scope of demonstrating an improved measurement scale factor thanks to the use of the cavity. A specific configuration will be studied for future GW detectors based on matter-wave interferometry [3].

Based on such developments, the perspective for this PhD project is to enable new applications for fundamental physics by extending atom gradiometry applications to the study of Dark Matter. The use of an interrogation cavity could for example enable new parameter space studies for virialized ultralight field candidates.

[1] B. Canuel, A. Bertoldi, L. Amand et al. **Exploring gravity with the MIGA large scale atom interferometer**. Sci Rep 8, 14064 (2018). <https://doi.org/10.1038/s41598-018-32165-z>

[2] D. O. Sabulsky, J. Junca, X. Zou, A. Bertoldi, M. Prevedelli, Q. Beaufils, R. Geiger, A. Landragin, P. Bouyer, B. Canuel, **Multi-photon Atom Interferometry via cavity-enhanced Bragg Diffraction**, arXiv:2201.11693 [physics.atom-ph] (2022), <https://doi.org/10.48550/arXiv.2201.11693>

[3] B. Canuel, S. Abend, P. Amaro-Seoane, et al. **ELGAR - a European Laboratory for Gravitation and Atom-interferometric Research**, Class. Quantum Grav. 37 225017 (2020), <https://doi.org/10.1088/1361-6382/aba80e>

- Exploit the promising potential of large momentum transferring beam splitters to boost the sensitivity of AI based experiments for a **new class of applications in fundamental physics.**
- Rely on the potential of **optical resonators** as a key technique for sensitivity improvement
- Study of different AI geometries using **high-finesse resonators** with the scope of demonstrating an improved measurement scale factor. A specific configuration will be studied for **future GW detectors** based on matter-wave interferometry
- Extend atom gradiometry applications to the **study of Dark Matter**. The use of an interrogation cavity could for example enable new parameter space studies for virialized ultralight field candidates.

Contact: Canuel Benjamin, [benjamin.canuel@institutoptique.fr](mailto:benjamin.canuel@institutoptique.fr)

# ParisTech

#Connect

#Innovate

#Share

[www.paristech.fr](http://www.paristech.fr)



ParisTech  
#Connect #Innovate #Share



ESPCI  PARIS  
EDUCATION SCIENCE INNOVATION

LABORATOIRE DE PHYSIQUE ET D'ETUDE DES  
MATÉRIAUX (LPEM)

ESPCI-PSL



# ESPCI Paris



ESPCI





# Micro & Nano Characterization Group (MNC)

- **Near-field optics** with fluorescent nanoprobe. Our activities concern the study of dielectric and plasmonic nanostructures using a scanning fluorescent probe that detects the near-field. We also study the interactions between fluorescent particles and the local environment.
- **Micro and nanothermics.** We study thermal properties of compounds and devices using a fluorescent scanning probe microscope. The particle acts as a nanothermometer. By analyzing fluorescence variations we can determine the temperature with a sub-micron lateral resolution.
- **Optoelectronics.** We develop and characterize new optoelectronic devices with new organic/inorganic hybrid materials : solar cells and light emitting devices.

Lionel Aigouy



Alexandre Zimmers



Zhuoying Chen



# VO<sub>2</sub>-BASED PLASMONIC HYBRID NANOSTRUCTURES FOR TUNABLE OPTICAL SENSORS

**Vanadium dioxide (VO<sub>2</sub>)** is a material that undergoes an Insulator to Metal phase Transition (IMT) very close to **room temperature** ( $T_c = 68 \text{ }^\circ\text{C}$ ). This transition is accompanied by a change in **electrical resistance** of several orders of magnitude, but also by strong variations of the **refractive index**, making it very interesting for developing a wide variety of **electronic and optical devices**. The objective of this project is to benefit from these unique properties and to use VO<sub>2</sub> in emerging applications:

- i) **Near-infrared photothermal detectors.**
- ii) **New micro-optoelectronic devices.** In contrast with previous studies, we will use focused **laser beams** to thermally induce the IMT at sub-micron scales.

## VO<sub>2</sub> insulator to metal transition

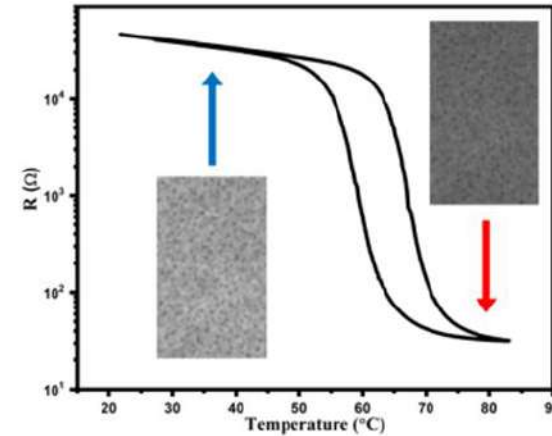

## Near-infrared photothermal detectors

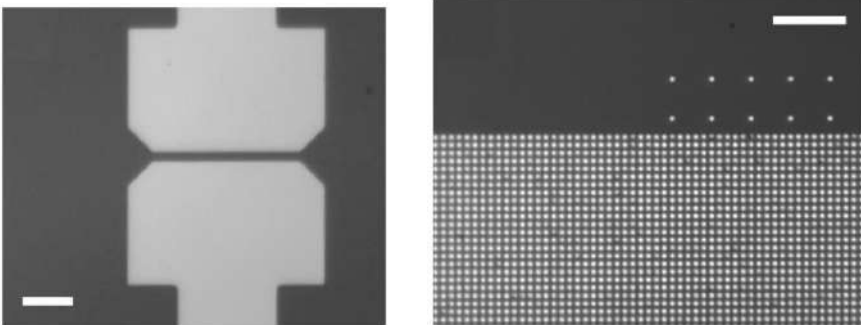

## New micro-optoelectronic devices using focused laser-induced heating

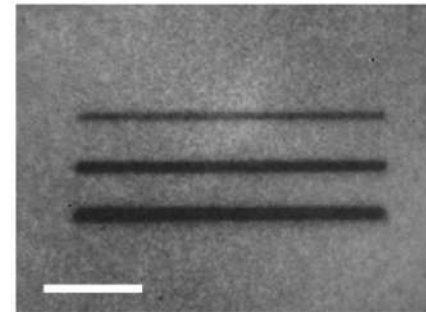

# ParisTech

#Connect

#Innovate

#Share

[www.paristech.fr](http://www.paristech.fr)

